



nemco[®] | FOOD
EQUIPMENT

making your
countertop
more profitable



nemco® | FOOD EQUIPMENT

Food Prep Equipment

CanPRO® Compact Can Opener	27
Easy Cheese Blocker™	26
Easy Cheeser™	26
Easy Chicken Slicer™	27
Easy Chopper™	13
Easy Chopper 2™	13
Easy Chopper 3™	11
Easy Dicer Two-Way Vegetable Cutter	23
Easy Flowering Onion™ Cutter	25
Easy FryKutter™	19
Easy Juicer™	28
Easy LettuceKutter™	21
Easy Onion Slicer 2™	21
Easy Pineapple Corer & Peeler	28
Easy Scooper™	9
Easy Slicer™ Vegetable Slicer	7
Easy Tomato Slicer™	9
Easy Tomato Slicer 2™	9
Easy Tuna Press™	28
Easy Vegetable Noodler	17
Easy Wedger™ & Easy Apple Corer™	23
NEW! Food-Grade Equipment Lubricant	30
Green Onion Slicer Plus	25
Monster Airmatic FryKutter™	19
Monster FryKutter™	19
PowerKut Food Cutter	15, 17
ProShucker® Power Shell Separator™	29
Roma Tomato Slicer	9
ShrimpPro 2000® Power Shrimp Cutter & Deveiner™	29
ShrimpPrep® RC-2001 Shrimp Cutter & Deveiner™	29
Spiral Fry™ Potato Cutter	15

Hot Dog Equipment

Bun & Food Warmers	38
Digital Roller Grills	35
Hot Dog Steamers	40
Mini Cart	40
Moist Heat Bun & Food Warmers	37
Roller Grills	33
Roller Grill Accessories	40
NEW! Roller Grill with Integrated Bun Drawer	36
Roller Grills with Digital Temperature Readout	34
Roller Grill Divider Kits	33
Self-Serve and Canopy Sneeze Guards	39
Slanted Roller Grills	34
Stainless Steel Bun Boxes	38
Tongs with Holder	39

Sandwich Press

NEW! PaniniPro™ High-Speed Sandwich Press	43-44
--	-------

Food Warming Equipment

Carving Station Bulb Warmers	47
Countertop Cookers & Warmers	53
Countertop Warmers	52
Freestanding & Suspended Infrared Bulb Warmers	46-47
Fresh-O-Matic by Nemco	54
Hot Plates	56
Infrared Strip Heaters	48-50
Mini Steam Table	55
Remote Control Boxes	51
Super Shot Countertop Steamer	54

NEW! Induction Equipment

Drop-In Warmers	59
Drop-In Ranges	59
Portable Ranges	60
Heavy-Duty Stockpot Ranges	60

Food Merchandising Equipment

Countertop Humidified Merchandiser	67
Grab 'n Go Merchandiser	67
Heat Shelves	70
Heated Display Cases	71
Heated Snack Merchandiser	69
Hot Holding Cabinets	71
NEW! Humidified Merchandiser	67
Open-View Merchandisers	63
Pizza Merchandisers	65
Popcorn Poppers	70
Pretzel Merchandisers	65
Shelf Merchandisers	69
Soup Merchandisers	72

Cold Food Holding

Cold Condiment Chillers	75
Cold Condiment Stations	75
Condiment Bars & Stations	76

Conveyor Toasters

2-Slice Toaster	78
3-Slice Toaster	78

Waffle & Cone Bakers

Batter Dispenser	82
Belgian Waffle Bakers	81
Cone Bakers	82
Waffle Bakers	80

Countertop Ovens & Boiling Unit

NEW! Countertop Boiling Unit	85
Countertop Ovens	86
Countertop Pizza Ovens	85
Countertop Warming & Baking Oven	86

Kitchen Essentials

Butter Spreader	89
Easy Grill Scraper™	89
Ice Cream Spade Wells	89
NEW! Rinsewell Dipper Well Controller	88
TaskMaster Timers	88

Food Waste Disposers

BusBoy by Nemco	90
-----------------	----

Expand your menu. Widen your margins. make more money

Nemco innovates countertop foodservice equipment solutions that bring your signature menu ideas to life, maximize your operation efficiency and boost your sales and profits!

Always look for this mark to be sure you're buying a Nemco original—every time.



Introducing Global Solutions—your connection to an even bigger world of ideas in countertop food equipment.

NEW!

Global Solutions: A Nemco Food Equipment company

Food Prep Equipment

Can Opener	93
Cheese Cutter	93
Chopper	92
Grill Scraper	93
Lettuce Chopper	92
Onion Slicer	92
Rotary Slicer	92
Tomato Slicer	92
Wall-Mount Chopper	92
Wedge Cutter	93

Food Merchandising Equipment

Closed Hot-Food Merchandisers	94
Solid Shelf Merchandisers	94
Wire Shelf/Pass-Through Merchandisers	94
Wire Shelf/Front Access Merchandiser	94
Open Hot-Food Merchandisers	94
Horizontal Dual-Shelf Merchandisers	94
Slanted Dual-Shelf Merchandisers	94

Countertop Ovens

Digital Multipurpose Oven	95
Digital Steam-Convection Oven	95
Manual Broiler-Convection Oven	95
Manual Convection Ovens	95
Manual Multipurpose Ovens	95
Manual Steam-Convection Oven	95

800.782.6761

Can't find the solution you need in this catalog?
Call us. Our engineers thrive on new challenges.

NemcoFoodEquip.com

what's new!

p.30



p.36



p.43



p.59-60



p.67



p.85



p.88





food prep equipment

easy slicer

vegetable slicer

Speed and Consistency . . . Unplugged

A true revolution in food prep, Nemco's Easy Slicer™ took the countertop stage as the first alternative to the electrical meat slicers so typically misused for cutting vegetables and fruit. After all, the only other option was a manual knife.

The electrical meat slicer was faster and automated, but expensive to maintain and off-limits to food-prep staff under 18. The knife was laborious and downright dangerous for the less experienced.

Quite simply, the Easy Slicer took the best of both worlds and made them better. Just as fast and even more precise, plus easier to clean than the meat slicer . . . safer and more consistent than a knife . . . the Easy Slicer still stands as Nemco's #1, most versatile and popular food-prep machine.



Easy Slicer™ Vegetable Slicer

Easy Slicer is the one slicer you need to make fast, easy work of most fruits and vegetables. Its unique, adjustable, stainless-steel blade provides a full range of slicing options—from 1/16-inch to 1/2-inch in thickness—for extra versatility and convenience. Simply turn the thumbscrew control to lock in your setting on the easy-to-read calibrated gauge. Use with the Nemco mounting base (sold separately) for a secure workstation, plus easy removal for cleaning and storage. Fixed blade units also available. Optional shredding plates fit all units.

Model #	Description	Replacement Blades
55200AN	Adjustable Cut	55135 (set of 2)
55200AN-4	1/8" Fixed Cut	55135 (set of 2)
55200AN-6	3/16" Fixed Cut	55135 (set of 2)
55200AN-8	1/4" Fixed Cut	55135 (set of 2)
55200AN-1	3/16" Shredder	55178
55200AN-2	5/16" Shredder	55179

Optional Accessories

Model #	Description
55257	Sharpening Stone
55263-1	3/16" Shredding Plates
55263-2	5/16" Shredding Plates
55816	Portable Base



Loading the Easy Slicer is a cinch. Just place your produce in the trough behind the blade, close the cover plate and go.



The sharpness and ease of rotation of the blade makes slicing a breeze, for super-fast, precisely consistent yield.

suggested uses

The perfect answer for uniform slicing of fresh vegetables and fruits for salad bars, sandwiches, pizza toppings and more.



Optional Shredding Plates—Shredding plates attach to the Easy Slicer in seconds for quick, easy shredding of cabbage, cheese, carrots, potatoes and other fruits and vegetables. Or choose the Easy Shredder, our shredding-only model.

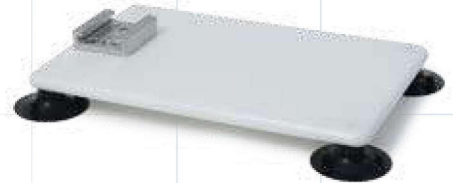

Portable Cutting Board Base—Maximize your counterspace with Nemco's portable, food-prep base, equipped with a mounting bracket that fits the Easy Slicer and a number of other Nemco food-prep products. The suction-cup feet provide incredible stability without damaging your countertop, and the entire unit is dishwasher safe.





easy tomato slicer 2

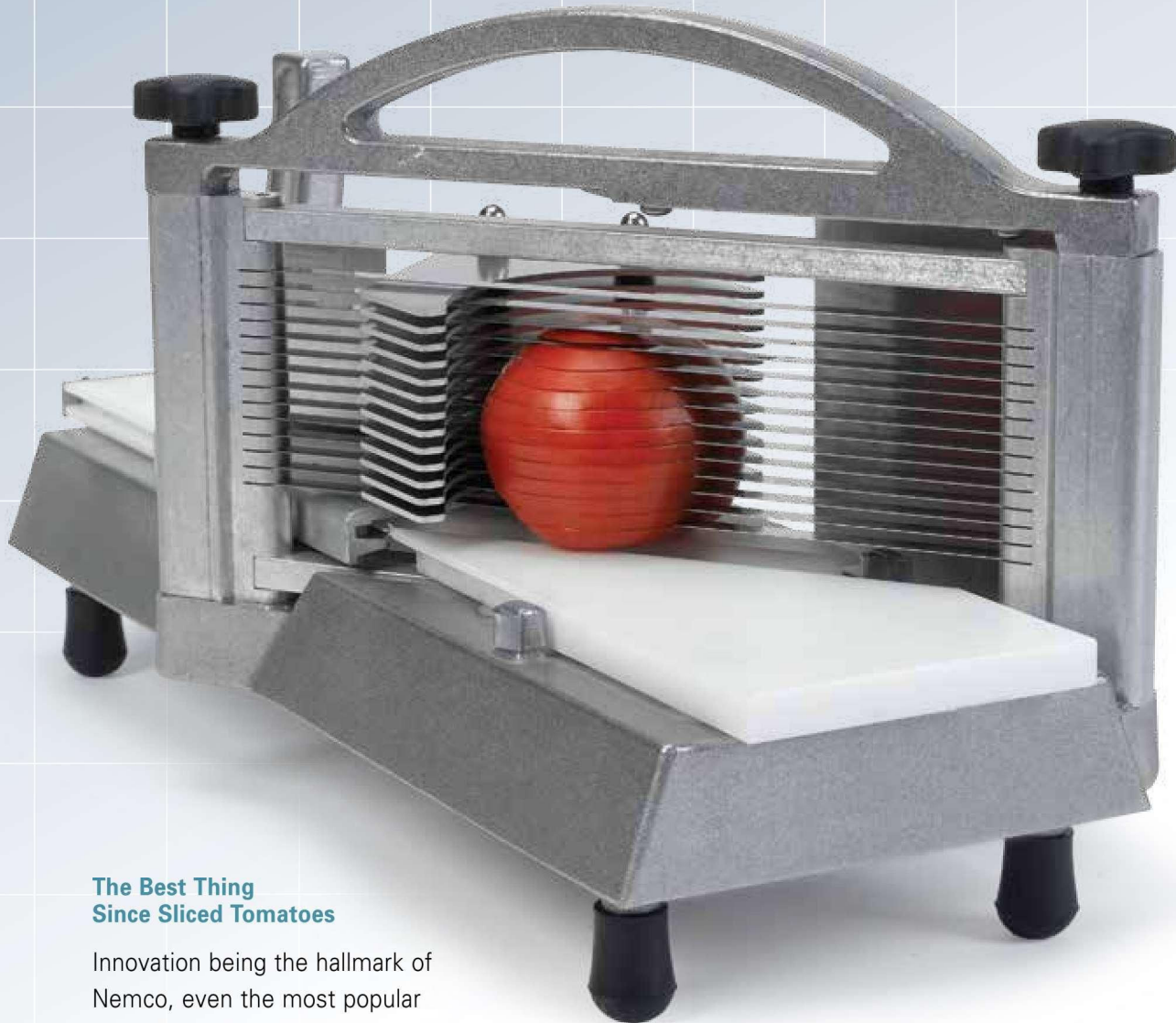

The Best Thing Since Sliced Tomatoes

Innovation being the hallmark of Nemco, even the most popular food equipment is never immune to design improvements. Nemco's Easy Tomato Slicer™ has been a breakthrough in fast, uniform tomato slicing, and has become a mainstay in commercial kitchens everywhere.

However, Nemco saw a need in the market for a simpler model that could deliver the same slicing precision, but with a faster,

easier method for changing the blades—particularly in the hands of younger, less experienced employees.

The result? Nemco's next generation, Easy Tomato Slicer 2™. And now, with a new, factory-pretensioned cartridge blade set, the 2 is winning over as many fans as its predecessor.

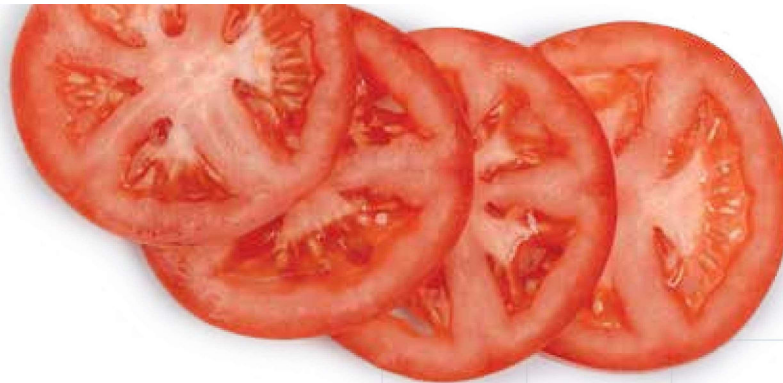

Easy Tomato Slicer 2™

Compact, efficient, easy to use and even easier to maintain, the new Easy Tomato Slicer 2 with its pretensioned cartridge blade assembly is more convenient than ever. The newly designed blade set stays properly aligned and tightened without the need to adjust it. The Easy Tomato Slicer 2 has an ergonomic handle, hand guards, self-lubricating track, rubber feet and a table stop like its predecessor, the Easy Tomato Slicer, a staple in foodservice kitchens. Accommodates a larger tomato than the original Easy Tomato Slicer. Scalloped blade options available.

Model #	Description	Replacement Blades
56600-1	3/16" Slice	566-1 (14 blades)
56600-2	1/4" Slice	566-2 (11 blades)
56600-3	3/8" Slice	566-3 (7 blades)

Note: See price list for scalloped blade ordering information.



Easy Tomato Slicer™

Save time, labor and valuable work space with the original Easy Tomato Slicer—still an immensely popular item for its incredibly compact design that is even shorter and narrower than the 2 model. Its unique self-lubricating track material alleviates misalignment problems that can cause nicks and broken blades. Vertical handle and protective guards improve user comfort and safety. Cleans up quickly and easily. Scalloped blade options available.

Model #	Description	Replacement Blades
55600-1	3/16" Slice	466-1 (13 blades)
55600-2	1/4" Slice	466-2 (10 blades)
55600-3	3/8" Slice	466-3 (7 blades)
55600-7	7/32" Slice	466-7 (11 blades)
55874-2	Easy Scooper™ Stem Remover, 2-pack	

Note: See price list for scalloped blade ordering information.



Roma Tomato Slicer

Need perfectly sliced Roma tomatoes super-fast? No problem. The Roma Tomato Slicer is designed to fit the unconventionally oblong roma tomato. It incorporates super-sharp, stainless-steel scalloped blades to pierce the tomato skin first, on the way to finishing a smooth, clean slice. The blades are pretensioned inside a cartridge blade assembly, to maintain precise spacing that ensures a consistently uniform slice and prolongs blade life. For cleaning or timely replacement, the blade assembly is easily removed with the simple pull of two pins.

Model #	Description	Replacement Blades
56610-1	3/16" Slice	567-1 (15 blades)
56610-2	1/4" Slice	567-2 (11 blades)



suggested uses

This is a must-have if you like to keep fresh tomatoes on hand for your burgers, sandwiches, salads, salad bars and condiment trays. It's great for slicing strawberries and mushrooms too.

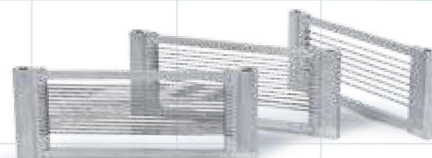

Blade Assemblies



Easy Scooper™—The essential tomato-prep tool. Removes stems with just one motion!



easy chopper 3



A Dream in Color

As if the Easy Chopper wasn't already saving kitchens time and money, along comes the 2, giving operators even more labor-cutting versatility (see page 13).

And, yet, in traditional Nemco style, the innovation just keeps coming.

Introducing—yes, that's right—the Easy Chopper 3, equipped with a spectrum of game-changing enhancements that further simplify the chopping chore.

Now, with color-coded blade assemblies and push blocks that make changeout super simple, a tougher nylon-resin push block that prolongs performance life and a revolutionary push-block gasket that takes all the tediousness out of cleaning, the Chopper 3 moves food prep from daunting to dreamy.

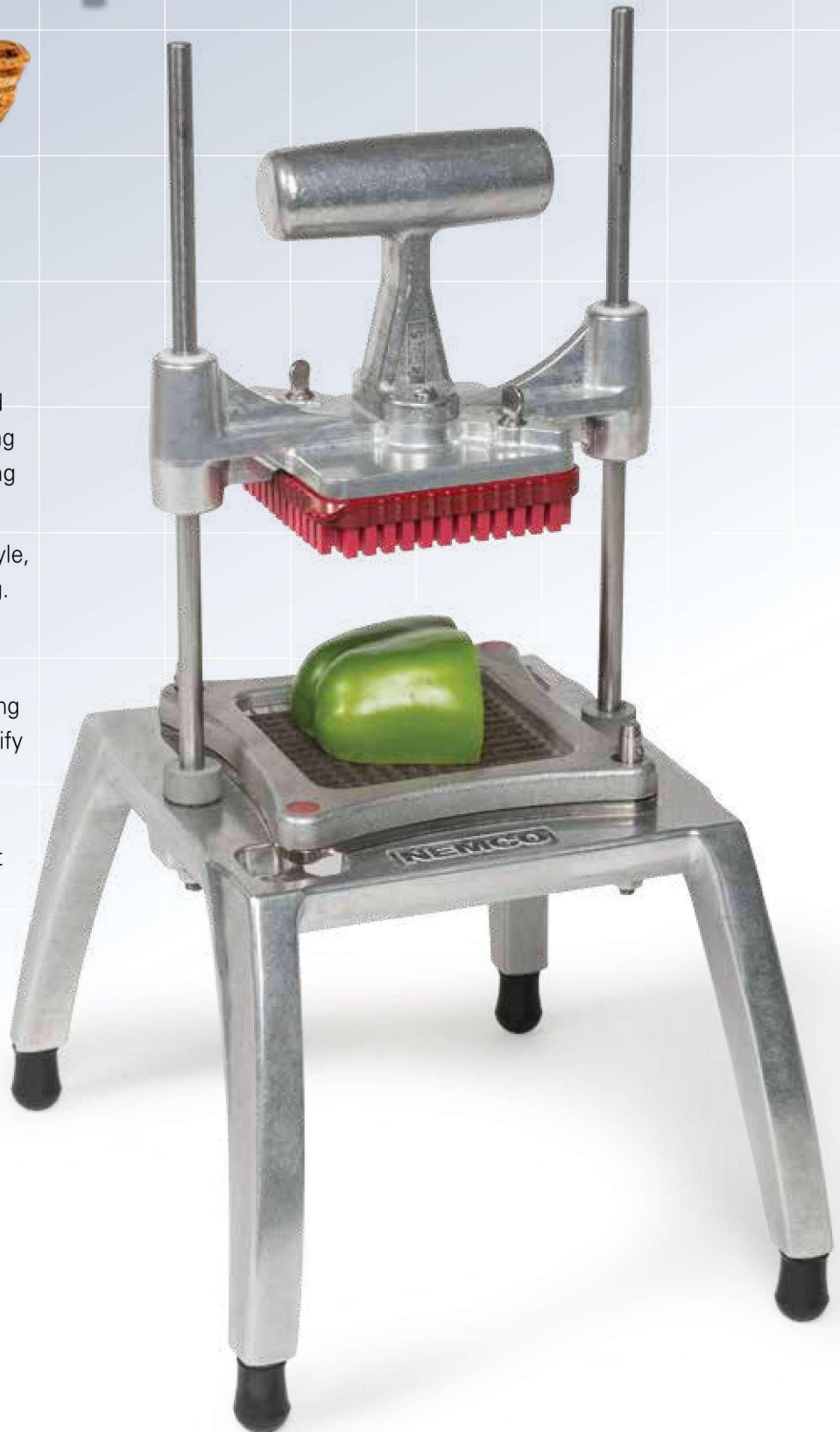



Easy Chopper 3™

Chopping just got faster and easier, yet again. And it all starts with the push block. In addition to being color-coded per the cut size of the corresponding blade-set—thus making destructive mismatches near impossible—each push block also features an intriguing ‘gasket’ innovation that makes cleaning as simple as pulling a tab. Like its Chopper 2 predecessor, the 3 includes a 4 1/4" cutting area for large vegetables, as well as a pretensioned slicing blade-cartridge design, aluminum and stainless-steel construction, and a sturdy, wide base, now high enough to sprawl a 1/6- or 1/3-size six-inch-deep food pan, or a two-quart round pan.

Model #	Description	Blade/Holder Assembly	Replacement Blades
57500-1	1/4"-Sq. Cut, Red	57424-1 (26 blades)	536-1
57500-2	3/8"-Sq. Cut, Blue	57424-2 (18 blades)	536-2
57500-3	1/2"-Sq. Cut, Green	57424-3 (12 blades)	536-3
57500-4	1"-Sq. Cut, Black	57424-4 (8 blades)	536-4
57500-5	1/4"-Thick Slice, Red	57424-5 (13 blades)	—
57500-6	3/8"-Thick Slice, Blue	57424-6 (9 blades)	—
57500-7	1/2"-Thick Slice, Green	57424-7 (6 blades)	—

Optional Accessories

Model #	Description
57417-1	Push Block, 1/4" Red
57418-2	Push Block, 3/8" Blue
57417-3	Push Block, 1/2" Green
57418-4	Push Block, 1" Black
56275-1	Cleaning Gasket, 1/4" Red, 3-pk
56275-2	Cleaning Gasket, 3/8" Blue, 3-pk
56275-3	Cleaning Gasket, 1/2" Green, 3-pk
56275-4	Cleaning Gasket, 1" Black, 3-pk
57727-6W	6-Section Wedger Kit
57727-8W	8-Section Wedger Kit
57424-1-PBG	1/4"-Cut Conversion Kit
57424-2-PBG	3/8"-Cut Conversion Kit
57424-3-PBG	1/2"-Cut Conversion Kit
57424-4-PBG	1"-Cut Conversion Kit
57424-5-PBG	1/4"-Slice Conversion Kit
57424-6-PBG	3/8"-Slice Conversion Kit
57424-7-PBG	1/2"-Slice Conversion Kit

Conversion Kit includes blade & holder assembly, push block and cleaning gasket.



The Chopper 3's interchangeable blade assemblies and push blocks are color coded to ensure fit and avoid destructive blade crashing.

suggested uses

The Easy Chopper 3 is the all-in-one heavy hitter for fast chopping, slicing and wedging of onions, tomatoes, potatoes, celery, peppers and other firm veggies. It's even the go-to for cutting fresh herbs, like cilantro, basil, parsley and more. It also cuts cooked chicken and ham! This reliable versatility, combined with its user-friendly fringe benefits, makes it the perfect tool for any high-speed kitchen.



Nemco's innovative push-block gaskets make cleaning a cinch. Just pull the gasket tabs to remove and clear away all the block's food debris in one simple motion.



Tall, sprawling base allows chopped produce to fall straight into a 1/6- or 1/3-size six-inch-deep food pan, or a two-quart round pan

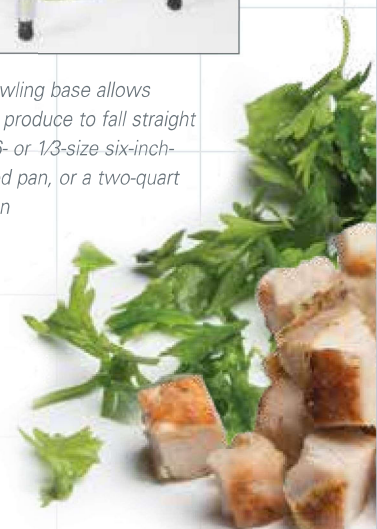

easy chopper



Chop Chop!

When high-volume foodservice establishments wrestling with high employee turnover needed a smarter, safer way to produce mounds of chopped produce in rapid-fire fashion, they naturally turned to Nemco.

Replace a knife with a blade grid and a gravity-driven pusher, and the resulting Easy Chopper has since become a staple item in kitchens all across the foodservice world.

In fact, it's been so effective, it remains a top seller in the entire Nemco lineup and a brilliant design-wise predecessor to the even more feature-evolved Easy Choppers 2 and 3.





Easy Chopper™

Easy Chopper is the original, most effective answer for fast, easy, efficient chopping. Comfortable, weighted handle does most of the work for you to cut cleanly in one stroke. Super-sharp, stainless-steel, interchangeable cutting grids let you perform six operations, including wedging. Plus, the compact 3½"-square cutting area maximizes counterspace.

Model #	Description	Blade/Holder Assembly	Replacement Blades
55500-1	¼" Cut	55424-1 (22 blades)	436-1 (22 blades, unassembled)
55500-2	⅜" Cut	55424-2 (16 blades)	436-2 (16 blades, unassembled)
55500-3	½" Cut	55424-3 (10 blades)	436-3 (10 blades, unassembled)
55500-4	1" Cut	55424-4 (4 blades)	436-4 (4 blades, unassembled)

Optional Accessories

Model #	Description
55417	Push Block, ¼" & ½"
55418	Push Block, ⅜"
55727-4	4-Section Wedger Kit
55727-6	6-Section Wedger Kit
55727-8	8-Section Wedger Kit



suggested uses

Use for fast, easy chopping, cutting and dicing of onions, tomatoes, potatoes, celery, peppers and other firm vegetables. Great for wedging citrus and other fruits, using the wedger kit.



Blade Assemblies

Easy Chopper 2™

Get the speed, efficiency and convenience of the Easy Chopper in a mightier model with a 4¼"-square cutting area, designed specifically for your BIG veggies! Now you can save labor by minimizing the need to pre-cut foods into smaller portions. But don't let the name fool you. This versatile tool chops, slices AND wedges! And, like the original version, it still features the weighted ergonomic handle. Plus, the slicing blades are factory pretensioned to remain properly aligned and tightened with no need for adjustment.

Model #	Description	Blade/Holder Assembly	Replacement Blades
56500-1	¼"-Sq. Cut	56424-1 (26 blades)	536-1 (26 blades, unassembled)
56500-2	⅜"-Sq. Cut	56424-2 (18 blades)	536-2 (18 blades, unassembled)
56500-3	½"-Sq. Cut	56424-3 (12 blades)	536-3 (12 blades, unassembled)
56500-4	1"-Sq. Cut	56424-4 (8 blades)	536-4 (8 blades, unassembled)
56500-5	¼"-Thick Slice	56424-5 (13 blades)	—
56500-6	⅜"-Thick Slice	56424-6 (9 blades)	—
56500-7	½"-Thick Slice	56424-7 (6 blades)	—

Optional Accessories

Model #	Description
56417	Push Block, ¼" & ½"
56418	Push Block, ⅜"
56727-6W	6-Section Wedger Kit
56727-8W	8-Section Wedger Kit



suggested uses

For salsa, pizza toppings, drink garnishes and more. Chops, slices and dices onions, tomatoes, potatoes, celery, peppers and other firm veggies. Great for wedging citrus and other fruits too, when using the wedger kit.

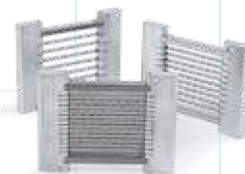

Pretensioned Slicing Blade Assemblies



Chopping/Wedging Blade Assemblies





spiral fry potato cutter

The Very First Twist on Food Prep

In 1981, as a machine shop, Nemco took on the challenge of a local restaurant owner who had a tasty moneymaking idea.

Seeing how much his patrons enjoyed his unique, spiral-shaped French fries, the restaurateur knew he could generate a much bigger profit

if he just had a lasting, commercial-grade tool that could take all the labor out of spiral-cutting his potatoes.

Nemco responded with its very first food equipment product—the Spiral Fry™.

Today, foodservice equipment of all kinds is all Nemco makes, and operators everywhere are earning a huge gross margin on every delectably crispy serving of spiral fries.





Spiral Fry™ Potato Cutter

Easily turns potatoes into money! Simply load up to a 70-ct. potato, and turn the easy-action drive screw. No peeling is required, and it easily releases for fast reloading. Mounts securely on any flat surface for left- or right-handed operation. Removes easily for quick cleanup. Fine Cut Garnish Cutter makes attractive vegetable garnishes quickly and easily. The Ribbon Fry Cutter makes a great side for sandwiches.

Model #	Description	Replacement Blades
55050AN 55017	Spiral Fry Front Plate Assembly	55002 Separating Blade 55003 Shearing Blade
55050AN-R 55876	Ribbon Fry Front Plate Assembly	55492 Shearing Blade —
55050AN-G 55711	Fine Cut Garnish Front Plate Assembly	55492 Shearing Blade 55702 Separating Blade
55050AN-WR 55876-WR	Wavy Ribbon Fry Front Plate Assembly	55492-WR Shearing Blade —
55050AN-CT 55876-CT	Chip Twister Fry (Straight) Front Plate Assembly	55492-CT Shearing Blade —
55050AN-WCT 55876-WCT 55816	Chip Twister Fry (Wavy) Front Plate Assembly Portable Base	55492-WCT Shearing Blade — —



Model 55816



suggested uses

Hot and crispy spiral, ribbon, wavy or chip twister fries make a savory, healthful, high-value presentation that customers love. Spiral Fry affords you the highest profit on every serving and pays for itself in no time. It's perfect for creating signature-item appetizers and is a great choice for the bar and lounge too.



Wavy Fry



Chip Twister Fry



Spiral Fry



Ribbon Fry



Garnish Cut



Model 55816-2

PowerKut Food Cutter

For mounds and mounds of today's most appetizing fries and garnishes, ask for the PowerKut Spiral Fry™, Ribbon Fry™, Wavy Fry™, Chip Twister Fry or Fine Cut Garnish Cutter. Each cuts with the innovation of the original Spiral Fry, but much faster and easier—going through an entire potato in as little as two seconds. Operation is simple—load, apply steady, even pressure and move the carriage forward. Wipes clean. Holds a 60-ct. potato.

Model #	Description	Replacement Blades
55150B-C 55707-1-C	Spiral Fry Spiral Fry Face Plate	55002 Separating Blade 55003 Shearing Blade
55150B-R 55707-1-R	Ribbon Fry Ribbon Fry Face Plate	55492 Shearing Blade —
55150B-G 55707-1-G	Fine Cut Garnish Garnish Cut Face Plate	55492 Shearing Blade 55702 Blade
55150B-WR 55707-1-WR	Wavy Ribbon Fry Wavy Ribbon Fry Face Plate	55492-WR Shearing Blade —
55150B-CT (Straight) 55707-1-CT (Straight)	Chip Twister Fry Chip Twister Fry Face Plate	55492-CT Shearing Blade —
55150B-WCT (Wavy) 55707-1-WCT (Wavy) 55816-2	Chip Twister Fry Chip Twister Fry Face Plate Portable Base	55492-WCT Shearing Blade — —

220-Volt and 230-Volt CE models are also available. Call for details.



Note: Blade assemblies are interchangeable and available separately. See price list for model numbers. Replacement blades fit both models.



easy vegetable noodler



Noodle On This

What do you do when the health-driven movement for “low carb” and “gluten free” doesn’t jive with the hunger-driven demand for pasta?

Turn to Nemco.

Seeing the rapidly rising trend that has the vegetable noodle

standing in for conventional spaghetti noodles in a multitude of menu alternatives, Nemco has introduced a smart, durable solution with the labor-efficient speed to satisfy customers more quickly and far more profitably.

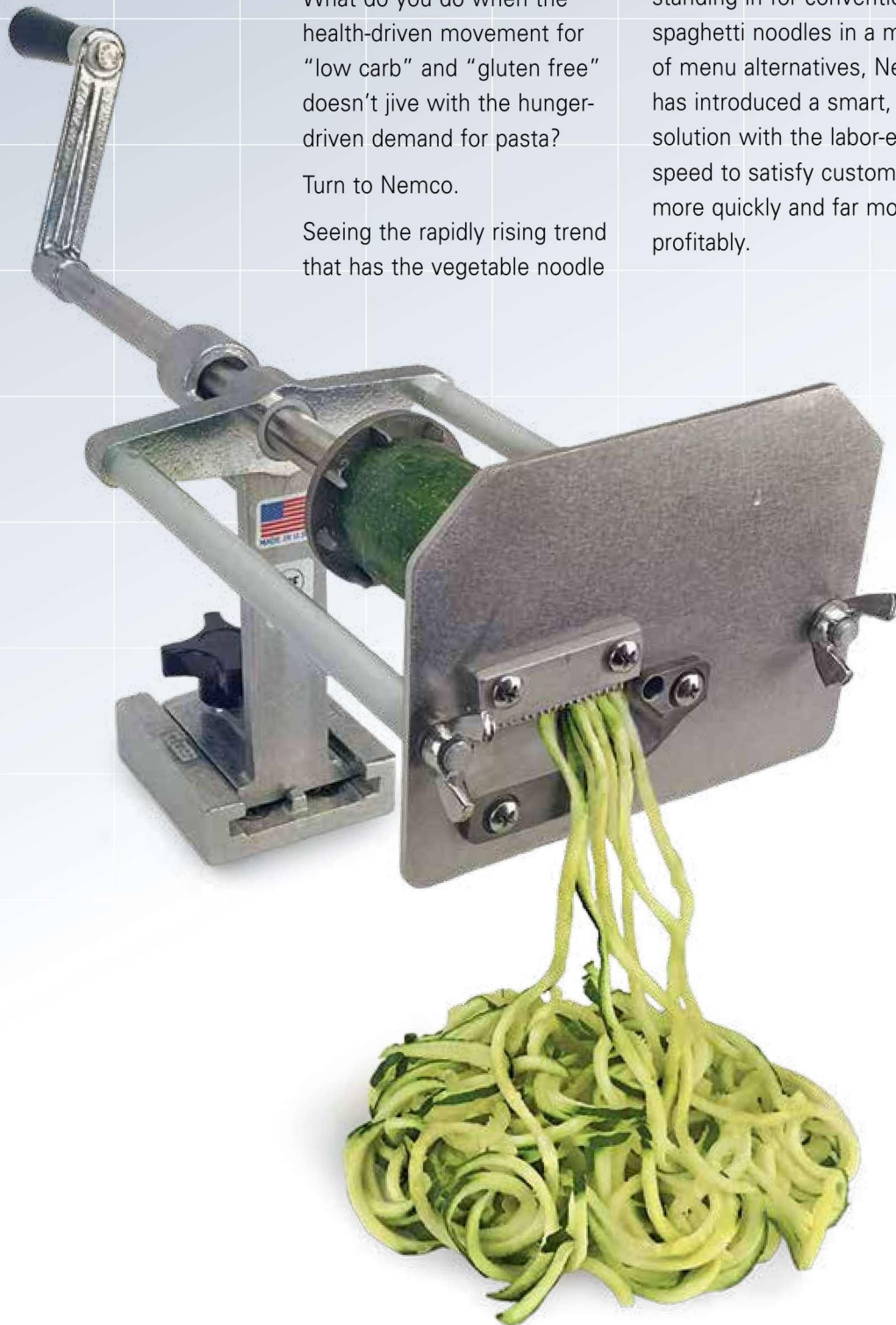



Easy Vegetable Noodler

Easily turn zucchini, squash or a variety of other firm veggies into piles of amazingly delicious, low-carb “spaghetti” noodles. Just load your choice veggie on the drive plate, turn the handle and go! Durable aluminum construction, with minimalist engineering that virtually eliminates maintenance issues, ensures lasting performance and fast ROI. Mounts securely to your countertop, while a twist of a few wing nuts simplifies disassembly for thorough cleaning. The only NSF-approved, commercial-grade device of its kind!

Model #	Description	Replacement Blades
55050AN-P	Vegetable Noodler, Manual	55702-1 Separating Blade 55003 Shearing Blade
55150B-P	Vegetable Noodler, PowerKut	55702-1 Separating Blade 55003 Shearing Blade

Optional Accessories

Model #	Description	
55816	Manual Portable Base	—
55816-2	PowerKut Portable Base	—



suggested uses

The Easy Vegetable Noodler is the must-have device for grocery deli counters, health-menu restaurants and other retail establishments looking to capitalize on the increasing demand for low-carb, gluten-free pasta alternatives. Makes spaghetti-like noodles out of zucchini, squash, potatoes, daikon, carrots and cucumbers.



Model 55150B-P

Even Easier!—For faster, easier production of zucchini noodles, Nemco also offers the electrically powered PowerKut Vegetable Noodler.

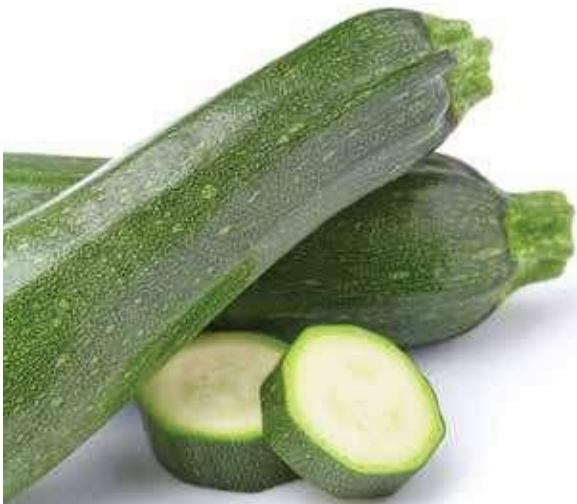

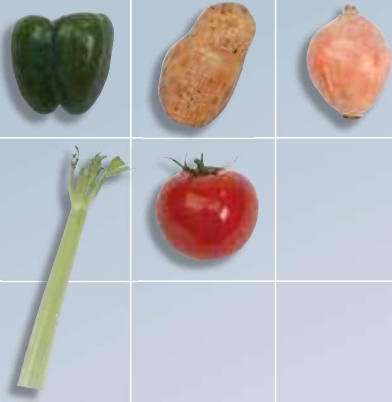

easy frykutter

vegetable cutter

Getting a Handle on the Hot Potato

The foodservice industry would be hard pressed to find a menu item more popular—or more stubborn to cut—than the French fry potato. So, when Nemco looked into developing a fry cutter, the food-

prep challenge of actually muscling a blade through a potato weighed heavily in the process.

Out of this emerged the appropriately named Easy FryKutter™, built with a number of user-driven features, such as the industry's only ergonomically designed "D" handle that reduces fatigue and increases productivity.

Now, regardless of the potato or the customer rush, when the pressure is on, nothing performs as reliably as Nemco—the durable and lasting workhorse that operates with a stroke of finesse.





Easy FryKutter™

Easy FryKutter uses an exclusive short throw handle and superior engineering to improve leverage for smooth, easy cutting or wedging in just one stroke. Works with natural body motion to eliminate awkward stretching and reduce operator fatigue. Built to last under the toughest day-to-day conditions. Slide-in, slide-out wall bracket fits the same mounting holes as most other machines.

Model #	Description	Blade/Holder Assembly	Replacement Blades
55450-1	1/4" Cut	55424-1	436-1 (set of 22)
55450-2	3/8" Cut	55424-2	436-2 (set of 16)
55450-3	1/2" Cut	55424-3	436-3 (set of 10)
55450-4	4-Section Wedge	—	428-4
55450-6	6-Section Wedge	—	428-6
55450-8	8-Section Wedge	—	428-8
55450-8C	8-Section Corer	—	490-8

Optional Accessories

Model #	Description
55641	Wall Bracket
55727-4	4-Section Wedger Kit
55727-6	6-Section Wedger Kit
55727-8	8-Section Wedger Kit



Wall Bracket

suggested uses

Cut potatoes for French fries and cut carrots and celery sticks. Chop onions, peppers, carrots and tomatoes. Wedge tomatoes for salads and potatoes for steak fries using the wedger kit. Great for wedging fruits too!



Blade Assemblies



Monster FryKutter™

Introducing the first potato-cutting tool that just eats up the massive "monster" potatoes, delivering a big 1/4", 3/8" or 1/2" square cut. The special blade assembly does all the work to minimize operator fatigue and maximize productivity, so you can make more money on the big monster appetite of your customers.

Model #	Description	Blade/ Holder Assembly	Replacement Blades
56450A-1	Stainless Blade Assembly Cuts 1/4" Sq. Cut	56424A-1MK	536-1
56450A-2	Stainless Blade Assembly Cuts 3/8" Sq. Cut	56424A-2MK	536-2
56450A-3	Stainless Blade Assembly Cuts 1/2" Sq. Cut	56424A-3MK	536-3

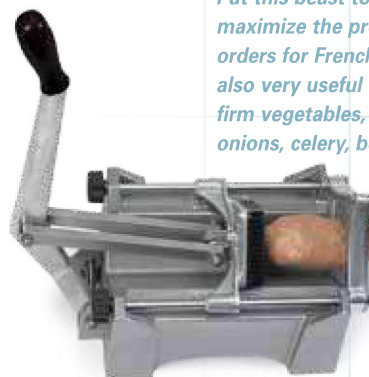

suggested uses

Put this beast to work if you want to maximize the profit potential on your orders for French fries or steak fries. It's also very useful for cutting other large, firm vegetables, including colossal onions, celery, bell peppers and more.

Monster Airmatic FryKutter™

Never let a wave of hungry customers down. When the popularity of French fries meets your busiest rush times, get more orders out and make more money with Nemco's Monster Airmatic FryKutter. Comes in 1/4", 3/8" or 1/2" square-cut sizes. Slicing blade assemblies are also available in 1/4", 3/8" or 1/2".

Model #	Description	Blade /Holder Assembly	Replacement Blades
56455-1	1/4" Sq. Cut	56424-1T	536-1T
56455-2	3/8" Sq. Cut	56424-2	536-2
56455-3	1/2" Sq. Cut	56424-3	536-3



suggested uses

It is a must-have for very high-volume fast-food and grab-and-go-style restaurants. Use this workhorse for French fries and steak fries, as well as various cuts of other vegetables, including onions, celery, bell peppers, tomatoes and more.



easy lettucekutter



Who Says You Can't Be All Things . . . ?

Make no mistake, if you're in foodservice, your bottom line can use the cost-cutting efficiency of Nemco's Easy LettuceKutter™.

It was originally designed for cutting iceberg lettuce in a high-volume, quick-service-type establishment. But then along came a restaurant looking to do the same with romaine for its popular Caesar salads . . .

And another wanting a square cut, perfect for its chop salads . . .

And another thinking it would be great to cut grilled chicken, right after cutting its lettuce . . .

And still others that have used it for slicing melon . . .

How 'bout you? Have any ideas? Nemco's always up for designing another blade set—or some other innovation entirely.



Easy LettuceKutter™

Cut mounds of crisp, fresh lettuce in seconds—and keep it fresh for hours, with a cut so incredibly clean, it prevents browning at the leaf edges. Process a whole head of cored lettuce at a time. Scalloped blades and a clean, slicing-action cut with no crushing and no bruising. Interlocked blades avoid flexing and require no tensioning. Plus, cleanup is easy.

Model #	Description	Blade Assembly	Replacement Blades
55650	1" x 1" Square	55485 (12 blades)	55470 (12 blades, unassembled)
55650-1	1/2" Slices	55495 (13 blades)	—
55650-2	For Romaine 1" x 2"	55485-2 (8 blades)	55470-2BR (8 blades, unassembled)
55650-3	1/2" x 1/2" Square	55924 (22 blades)	55923 (22 blades, unassembled)
55650-CS	3/8" Slices	55882 (17 blades)	—
55650-6	3/4" x 3/4" Square	55485-6 (16 blades)	55470-6 (16 blades, unassembled)

Optional Accessories

Model #	Description
55491	Easy LettuceKutter Support Board w/Opening



suggested uses

Ideal for chopping iceberg and other lettuces, as well as slicing melons for fruit trays. Also slices lettuce for tacos and sandwiches. 55650-CS can be used to slice cooked chicken for wraps and salads.



Blade Assemblies



Support Board w/Opening

NSF polyethylene board fits securely over 20- and 32-gallon lettuce-keeper containers. Also holds other lettuce-cutting machines.

Easy Onion Slicer 2™

Takes EASY to a whole new level . . . because a NEW factory-pretensioned blade set NEVER, EVER needs tightening! Even your most inexperienced employees can easily change the blades. Process up to a 4-inch diameter onion. But don't stop there. This remarkably versatile tool can make fast work of just about anything in the produce department!

Model #	Description	Blade Assembly
56750-1	3/16" Slicer	56539-1 (17 blades)
56750-2	1/4" Slicer	56539-2 (13 blades)
56750-3	3/8" Slicer	56539-3 (9 blades)
56750-4	1/2" Slicer	56539-4 (7 blades)



suggested uses

Ideal for onions, celery, potatoes, pickles, firm tomatoes, oranges, lemons and limes.

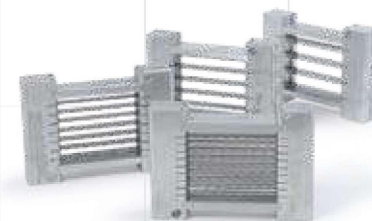

Blade Assemblies





easy wedger & easy apple corer



Foodservice's Equivalent to the Paper Clip

They call it a staple item. A must-have. A no-brainer. And if you're serving schools, using the corer version is probably the only way you can get the students to eat their apples.

No matter how you slice it, it's one of your most inexpensive solutions for making your food-prep work a whole lot easier.

Granted, Nemco didn't develop the first wedger, or even master the first manual wedging-tool concept. But the way Nemco looks at it, if it's going to be a staple item, it should last a heck of a long time.

So, this one—simply called the Easy Wedger™—is built to operate more smoothly and more durably than any other.



Easy Wedger™ & Easy Apple Corer™

Save labor, and cut perfect wedges every time. Easy Wedger cuts cleanly and precisely with stay-sharp stainless-steel blades that minimize bruising. Works so fast, you can cut to order for the freshest selections possible. Built for years of reliable performance. Eight-section Easy Apple Corer looks and functions just like the Wedger, but it includes a pin in the middle of the pusher to simultaneously core while wedging.

Model #	Description	Blade Assembly
55550-4	4-Section Wedge	428-4
55550-6	6-Section Wedge	428-6
55550-8	8-Section Wedge	428-8
55550-10	10-Section Wedge	428-10
55550-8C	8-Section Corer	490-8



suggested uses

Easy Wedger is ideal for beverage operations. Use it for fresh lemon, lime and orange garnishes. Works great at the salad bar too. Try it with tomatoes, pickles, potatoes, cucumbers and zucchini.



Eight-section Easy Apple Corer—Cores and wedges at once—ideal for apples and pears.

Easy Dicer Two-Way Vegetable Cutter

In seconds, Easy Dicer provides uniform, precision dicing in one quick, easy operation. Cuts onions five times faster than by hand, up to 100 pounds in only 45 minutes. Unique two-way cutting action dices and slices at once, minimizing handling, providing cleaner cuts, and producing crisper, juicier shapes. Consistent output increases yield and reduces food waste. Constructed of rugged cast aluminum, stainless steel and engineered plastics for years of dependable service. Holds onions up to 3½ inches in diameter.

Model #	Description	Blade Assembly
55100E	¼" x ¼" x ¼" Cut	55022A

Additional Blade Assembly Options

Model #	Description
55125	½" Grid Assembly Cuts ½" x ½" x ¼" Cut
55065A	⅛" Rotary Cutter Assembly Cuts ¼" x ¼" x ⅛" Cut
55816	Portable Base

Note: To change cut size from base model 55100E, purchase additional blade assemblies from above.



suggested uses

Ideal for dicing onions, potatoes, celery, green peppers and other toppings used for pizza, burgers, coney dogs, tacos, soups, stews, salads and more. For dicing firm tomatoes, use blade assembly 55125. Place cut side of tomato against blade.



Blade Assemblies



Model 55816



easy flowering onion cutter



Crying All the Way to the Bank

Not long ago, a major national restaurant chain stumbled on an onion-appetizer idea that was as grand in presentation as it was in flavor. But the prep work was a bit much, and the kitchen couldn't stay on top of the tidal wave of orders.

Enter Nemco.

Now, the Easy Flowering Onion™ Cutter takes virtually all the labor out with one motion, transforming this trademark menu favorite into a much more cost-effective production and enabling the chain to turn a 700 percent profit.



Easy Flowering Onion™ Cutter

Use for the authentic cut that lets you serve today's most profitable, great-tasting appetizers—for a return of 700 percent or more! The Easy Flowering Onion Cutter produces these high-profit specialties fast—and oh, so easy. Just one stroke turns a colossal onion into a colossal, flowering favorite. Then batter, bread and deep fry. Adapter base lets you use smaller onions as well. Sturdy, all-metal construction for long life.

Model #	Description	Blade Assembly
55700	Onion Cutter	55511
55526	Small Onion Adapter	Included with Model 55700
55513	Core Cutter, Large 2 ³ / ₄ "	Included with Model 55700
55527	Core Cutter, Small 1 ³ / ₄ "	Included with Model 55700



suggested uses

Create the perfect signature-item onion appetizer. Or dip the ends of a flowered raw onion in food coloring to create magnificent onion garnish. Use with colossal and smaller-sized onions.



Core Cutter—Remove onion core with the Core Cutter, and you create space to add a ramekin filled with delicious dipping sauce.

Green Onion Slicer Plus

For fast, fresh-sliced garnishes, salad toppings, appetizers, soup starters and more, choose the Green Onion Slicer Plus. It makes mounds of perfect slices in just one labor-saving stroke. Faster than knives or scissors. Razor-sharp blades are individually replaceable. Wall-mount design saves valuable counterspace.

Model #	Description	Replacement Blades
55250A	3/16" Cut	55225-6 (set of 6)



suggested uses

Slices green onions, mushrooms, peeled cucumbers, olives, bananas, green peppers, strawberries and other fruits and vegetables into perfect 3/16" slices.





suggested uses

The Easy Cheeser is perfect for salad bars, deli trays, party packs, in-store sampling, hors d'oeuvres and specialty trays. Great for butter too! Makes individual pats and serving-size squares.



Model 55300A



Model 55300A-516D

Mozzarella Specialty Unit—Will slice other cheeses, but frame is designed to cradle mozzarella, and cutting wires are spaced specifically for 5/16" slices.

Easy Cheeser™

Save time and labor with Easy Cheeser cheese cutters. These rugged, all metal units cut uniform cubes, sticks, squares and rectangles of everybody's favorite cheeses, including mozzarella, Monterey Jack, cheddar, Muenster, Swiss, American and more. Slicing arms are interchangeable and easy to switch. Stainless-steel cutting wires are replaceable. Cubes a five-pound cheese loaf in only 75 seconds.

Model #	Description	Wire Kit
55300A	3/4" Slicing Arm	55288
55300A-1	3/8" Slicing Arm	55288
55300A-2	3/4" and 3/8" Arms	55288
55300A-516D	5/16" Slicing Arm	55288



3/8" stick



3/8" x 3/4" stick



3/4" stick



3/4" cube



3/8" cube



3/4" x 3/4" x 3/8"
square block



3/4" x 3/8" x 3/8"
rectangular block



suggested uses

Use with the Nemco Easy Cheeser cutter for a total cheese-prep center.



Easy Cheese Blocker™

Cut cheese blocks down to size in seconds for more manageable cubing, slicing and shredding. Sturdy, all stainless-steel construction and rigid cutting bow ensure straight, even cuts plus long life. Calibrated, notched, 1/2-inch cutting guide helps to improve consistency and reduce waste. Stainless-steel cutting wire is easily replaced. Process 40-pound cheese blocks, 35-pound cheese wheels or smaller.

Model #	Description	Wire Kit
55350A	Cheese Block Cutter	55359-P3





The CanPRO Compact from Nemco easily fits #2-, #5- and #10-sized cans.



CanPRO® Compact Can Opener

Nemco's unique mechanical design thinks outside the can! Instead of cutting down vertically into the lid, the CanPRO Compact cuts horizontally into the rim for improved food safety, as well as operator safety. Cutting from the outside, the blade assembly crimps as it cuts, eliminating the sharp edge that can slice a hand or damage a spatula. Plus, it leaves no metal slivers that can fall into the food contents. Running the circumference of a #10-sized can just takes a few quick and easy turns of the crank. It's adjustable to all common can sizes and features a permanent mount with an optional temporary clamp, allowing you to move the opener around the kitchen. Security model option available.

Model #	Description	Replacement Cutter
56050-1	CanPRO Compact, Permanent Mount	56029
56050-2	CanPRO Compact, Temporary Mount	56029
56050-3	CanPRO Compact, Security Model	56029
56022A	Cutter Housing Assembly	—



suggested uses

If your operation is trying to maximize the exploding popularity of chicken salads and sandwich wraps, this is the tool you need. It quickly and easily cuts through chicken and turkey breasts.



Easy Chicken Slicer™

Cut your labor, not your hands, with the new Easy Chicken Slicer. The ingeniously simple design features a unique assembly of *unsharpened* blades that make quick work of breaded, cooked chicken breast. Compared to the conventional knife-in-hand alternative, the Easy Chicken Slicer performs with superior speed, consistency and, above all, safety—with virtually no training required! Cleanup is a breeze. Sharpened blades are also available for cutting other foods. All blades come as factory-pretensioned blade cartridges for super-fast and easy changeout.

Model #	Description	Blade Assembly
55975	1/2" Slice	55868
55975-SC	1/2" Slice (Scalloped)	55868-SC
55975-1	3/8" Slice	55868-1
55975-1SC	3/8" Slice (Scalloped)	55868-1SC
55975-2	1/4" Slice	55868-2
55975-2SC	1/4" Slice (Scalloped)	55868-2SC



Blade Assemblies



suggested uses

Ideal for oranges, lemons and limes. Lets you quickly prepare the freshest possible lemonade, limeade, tropical drinks and other seasonal specialties.



Easy Juicer™

Easy Juicer puts a 20:1 mechanical advantage in the palm of your hand. Specially designed ergonomic handle is easy to grip. Stainless-steel rack and pinion is supported between two self-lubricating bronze bearings. High-strength steel post adds rigidity. Aluminum and stainless-steel construction plus all stainless-steel fasteners for rugged performance and durability. Strainer cone and cup are removable.

Model #	Description
55850	Citrus Juicer



Easy Pineapple Corer & Peeler

Take all the labor out of prepping a pineapple. Nemco's latest countertop innovation completely removes the core and peel with one simple pull of its easy-action, top-down lever. Saves time, effort and food waste. A locking mechanism keeps the handle and blade in the up position while loading a pineapple. Tough aluminum and stainless-steel construction and easy disassembly for cleaning extend the life of the unit for great return on investment.

Model #	Description	Blade Assembly
55775	3.5" Pineapple Corer & Peeler	56511
55775-1	4" Pineapple Corer & Peeler	56511-1

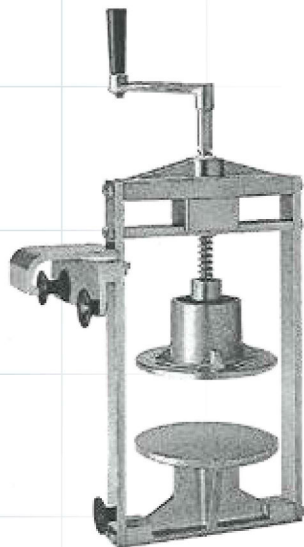

Easy Tuna Press™

Removes excess water from canned tuna quickly and easily for better food quality. Sandwiches and salads stay fresh longer, retain a more appetizing appearance because extra water that causes soggy bread and lettuce is completely removed. Holds one 64-ounce foodservice-sized can.

Model #	Description
55800	Tuna Press



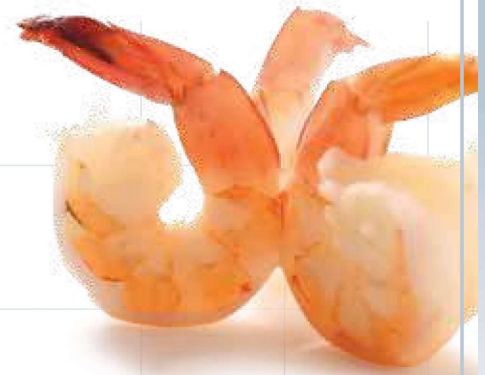

suggested uses

The ShrimpPro is the perfect answer for uniform deveining and butterflying shrimp for seafood bars and buffets, Asian stir-fry restaurants, caterers and other seafood specialty restaurants and retailers.

Low- to medium-volume seafood operators should opt for the ShrimpPrep.



ShrimpPro 2000® Power Shrimp Cutter & Deveiner™

Keep pace with the demand of your hungriest shrimp lovers! In just one hour, the ShrimpPro instantly and consistently deveins, cuts, butterflyes or splits up to 6,000 shrimp! Operators can hand-feed or attach the feeder tray for higher volumes. Either way, the ShrimpPro does all the work with virtually no risk of injury. Compact, portable design saves space and makes for easy storage. ShrimpPrep is specially designed to operate with your existing Robot Coupe™ food processor.

Model #	Description	Replacement Blades
55925*	ShrimpPro® (2000)	55977
55950	ShrimpPrep® (RC-2001)	55977

Comes with feeder tray, S-M-L depth rollers, lubricant, and two 9¹/₁₆" blade wrenches. Available also in 230-Volt CE model. Call for details.

Optional Accessories

Model #	Description
56004	ShrimpPro® Feeder Tray
55991	ShrimpPrep® Feeder Tray

Robot Coupe™ is a trademark of Robot Coupe USA.



suggested uses

Perfect for restaurants with oyster bars and seafood buffets, as well as catering operations and supermarkets.



ProShucker® Power Shell Separator™

The ProShucker quickly and cleanly opens up a dozen oysters a minute with virtually 0% risk and 100% yield. A dull-threaded bit gently pries open the shell. Works fast, and evacuates all mud and shell fragments, so you yield maximum meat with minimum contamination. Best of all, the ProShucker is so easy to use, it requires almost no training!

Model #	Description	Replacement Bit
55900	ProShucker® (PSS-100)	55957 (set of 3)

Comes with foot pedal, 3 bits/augers and 2 bit replacement wrenches. Available also in 230-Volt model. Call for details. All 230V units are shipped without plug on cords.



food-grade equipment lubricant



Model 56075

Improve the performance and longevity of your food equipment with Nemco's Pro-Food oil and grease products—specially formulated and USDA H1-rated for surfaces that have direct food contact. Completely sanitary, nontoxic, odorless and tasteless, Pro-Food effectively and precisely lubricates equipment slides, shafts, bearings and other moving mechanical parts to smooth out noise and friction during operation. Plus, Pro-Food also protects surfaces by acting as a rust-inhibitive coating on non-stainless metals and a nonstick coating on protein-cutting surfaces that can otherwise be difficult to clean. Available as a low-viscosity oil in a spray can or a high-viscosity grease in a tube.

Pro-Food Equipment Lubricant **NEW!**

Improve the performance and longevity of your food equipment with Nemco's Pro-Food oil and grease products—specially formulated and USDA H1-rated for surfaces that have direct food contact. Completely sanitary, nontoxic, odorless and tasteless, Pro-Food effectively and precisely lubricates equipment slides, shafts, bearings and other moving mechanical parts to smooth out noise and friction during operation. Plus, Pro-Food also protects surfaces by acting as a rust-inhibitive coating on non-stainless metals and a nonstick coating on protein-cutting surfaces that can otherwise be difficult to clean.

Model #	Description
47709	Pro-Food Equipment Grease Gel, 1oz
47709-50	Pro-Food Equipment Grease Gel, 1oz (case of 50)
56075	Pro-Food Equipment Oil Spray, 16oz
56075-12	Pro-Food Equipment Oil Spray, 16oz (case of 12)



Model 47709

Available as a low-viscosity oil in a spray can or a high-viscosity grease in a tube.

hot dog equipment

roller grills

Famous Old Dog. Exciting New Tricks.

In the tradition of allowing the market to influence design, when Nemco acquired the very first roller grill, the next immediate move was to find out how it could serve foodservice operators like you even better.

Now, along with its steadfast appeal as the true original of its kind, the Nemco Roller Grill

operates more quietly, sports a sharper front-of-the-house look, and features even heat distribution completely across every roller. . . . Oh, yeah, and it's built to last even longer than the decades-old original units still going strong today.



Model 8027

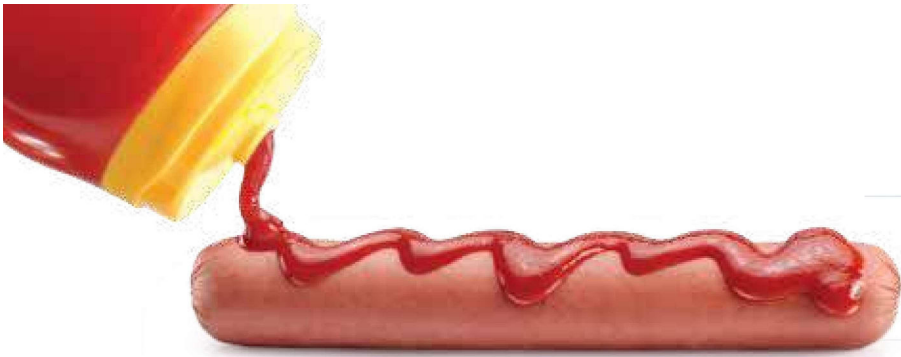

Roller Grills

Let profits roll! Grill hot dogs, egg rolls, taquitos and more. The 360° roller rotation prevents residue buildup, while individual roller heating elements ensure heating consistency. Removable drip pan makes for easy cleaning. Inside, new grease seal feature prevents grease buildup inside the bearing. Electric power requires no ventilation system, and infinite heat settings offer convenient temperature control. For optimum roller-performance capability, look for Gripslt models that include nonstick properties with grip- and abrasion-resistant additive.



Model 8010

Model #	Description	Size (W x D x H)	Volts	Watts	Amps	No. of Rollers	No. of Cords	No. of 5" Franks Per Hour
8010	Holds 10 Hot Dogs, Chrome	16" x 11" x 7 ¹ / ₄ "	120	330	2.8	6	1 / 5-15P	10-200
8010SX	Holds 10 Hot Dogs, w/Gripslt *	16" x 11" x 7 ¹ / ₄ "	120	330	2.8	6	1 / 5-15P	10-200
8018	Holds 18 Hot Dogs, Chrome	18 ¹ / ₂ " x 16 ¹ / ₄ " x 7"	120	950	7.9	10	1 / 5-15P	18-360
8018SX	Holds 18 Hot Dogs, w/Gripslt *	18 ¹ / ₂ " x 16 ¹ / ₄ " x 7"	120	950	7.9	10	1 / 5-15P	18-360
8027	Holds 27 Hot Dogs, Chrome	22 ¹ / ₄ " x 16 ¹ / ₄ " x 7"	120	950	7.9	10	1 / 5-15P	27-540
8027SX	Holds 27 Hot Dogs, w/Gripslt *	22 ¹ / ₄ " x 16 ¹ / ₄ " x 7"	120	950	7.9	10	1 / 5-15P	27-540
8036	Holds 36 Hot Dogs, Chrome	29 ¹ / ₂ " x 16 ¹ / ₄ " x 7"	120	1500	12.5	10	1 / 5-15P	36-720
8036SX	Holds 36 Hot Dogs, w/Gripslt *	29 ¹ / ₂ " x 16 ¹ / ₄ " x 7"	120	1500	12.5	10	1 / 5-15P	36-720
8045W	Wide, Holds 45 Hot Dogs, Chrome	35 ¹ / ₂ " x 16 ¹ / ₄ " x 7"	120	1800	15.0	10	1 / 5-15P	45-900
8045SXW	Wide, Holds 45 Hot Dogs, w/Gripslt *	35 ¹ / ₂ " x 16 ¹ / ₄ " x 7"	120	1800	15.0	10	1 / 5-15P	45-900
8045N	Narrow, Holds 45 Hot Dogs, Chrome	22 ¹ / ₄ " x 25 ³ / ₄ " x 7"	120	1520	12.7	16	1 / 5-15P	45-900
8045SXN	Narrow, Holds 45 Hot Dogs, w/Gripslt *	22 ¹ / ₄ " x 25 ³ / ₄ " x 7"	120	1520	12.7	16	1 / 5-15P	45-900
8075	Holds 75 Hot Dogs, Chrome	35 ¹ / ₂ " x 25 ³ / ₄ " x 7"	120	2880	24.0	16	2 / 5-15P	75-1500
8075SX	Holds 75 Hot Dogs, w/Gripslt *	35 ¹ / ₂ " x 25 ³ / ₄ " x 7"	120	2880	24.0	16	2 / 5-15P	75-1500



Model 8018 and 8018GD



Model 8027SX



Model 8036SX



Model 8045N and 8045NGD

220-Volt and 230-Volt CE models are also available. Call for details. *See description of Gripslt on pg. 34.



Roller Grill Divider Kits

Divider kits are available for most Nemco Roller Grills. 80440 kits include convenient self-serve tongs, tong holder and control cover. (See photo on pg. 39.)

Model #	Description
80435-27	Fits 8027 Series Roller Grills
80435-36	Fits 8036 Series Roller Grills
80435-45N	Fits 8045N Series Roller Grills
80435-45W	Fits 8045W Series Roller Grills
80435-75	Fits 8075 Series Roller Grills
80440-30	Fits 8230 Series Roller Grills
80440-50	Fits 8250 Series Roller Grills

Note: For divider kits that fit Slanted Roller Grills, specify the kit's model number above with an SLT suffix. Example: For Slanted Roller Grill model #8027-SLT, order divider kit #80435-27-SLT.



Model 8045SXW-SLT.
Tongs and tong holder
sold separately (pg. 39).

Gripslt Rollers! Only from Nemco

Sell more taquitos, pancake rollups and other specialty roller-grilled foods with Nemco's proprietary *Gripslt*[™] roller coating—available on all Roller Grill models. *Gripslt* combines a subtle friction characteristic with a smooth surface finish, optimizing cooking rotation without giving up the important food-safety cleanability of conventional chrome rollers.

Slanted Roller Grills

A special tiered roller design adds an effective merchandising edge, because it brings the deliciously tempting grilled hot dogs into better view for your customers. For a high-capacity slanted grill option—without a major investment upgrade—take a look at Nemco's NEW slanted model options. And, for optimum roller performance, consider Nemco's *Gripslt* models, featuring a proprietary roller coating that grips and turns better than chrome, but cleans up just as easily!

Model #	Description	Size (W x D x H)	Volts	Watts	Amps	No. of Rollers	No. of Cords	No. of 5" Franks Per Hour
8027-SLT	Slanted, Holds 27 Hot Dogs, Chrome	22 ¹ / ₄ " x 16 ¹ / ₄ " x 10 ¹ / ₄ "	120	950	7.9	10	1 / 5-15P	27-540
8027SX-SLT	Slanted, Holds 27 Hot Dogs, w/ <i>Gripslt</i>	22 ¹ / ₄ " x 16 ¹ / ₄ " x 10 ¹ / ₄ "	120	950	7.9	10	1 / 5-15P	27-540
8033SX-SLT	Slanted, Holds 33 Hot Dogs, w/ <i>Gripslt</i>	23 ³ / ₄ " x 20 ¹ / ₈ " x 10 ³ / ₈ "	120	1200	10.0	12	1 / 5-15P	33-660
8036-SLT	Slanted, Holds 36 Hot Dogs, Chrome	29 ¹ / ₂ " x 16 ¹ / ₄ " x 10 ¹ / ₄ "	120	1500	12.5	10	1 / 5-15P	36-720
8036SX-SLT	Slanted, Holds 36 Hot Dogs, w/ <i>Gripslt</i>	29 ¹ / ₂ " x 16 ¹ / ₄ " x 10 ¹ / ₄ "	120	1500	12.5	10	1 / 5-15P	36-720
8045W-SLT	Wide, Slanted, Holds 45 Hot Dogs, Chrome	35 ¹ / ₂ " x 16 ¹ / ₄ " x 10 ¹ / ₄ "	120	1800	15.0	10	1 / 5-15P	45-900
8045SXW-SLT	Wide, Slanted, Holds 45 Hot Dogs, w/ <i>Gripslt</i>	35 ¹ / ₂ " x 16 ¹ / ₄ " x 10 ¹ / ₄ "	120	1800	15.0	10	1 / 5-15P	45-900
8055SX-SLT	Slanted, Holds 55 Hot Dogs, w/ <i>Gripslt</i>	35 ³ / ₄ " x 20 ³ / ₈ " x 10 ³ / ₈ "	120	1560	13.0	12	1 / 5-15P	55-1100

220-Volt and 230-Volt CE models are also available. Call for details.



Roller Grills with Digital Temperature Readout

A new twist on Nemco's original roller grill—a digital temperature readout with a mechanical temperature control. For optimum roller-performance capability, look for *Gripslt* models that include nonstick properties with grip- and abrasion-resistant additive.



Model 8050SX-RC

Model #	Description	Size (W x D x H)	Volts	Watts	Amps	No. of Rollers	No. of Cords	No. of 6" Franks Per Hour
8050SX-RC	Roller Grill, 50 Hot Dogs, <i>Gripslt</i>	35 ³ / ₄ " x 18 ⁹ / ₁₆ " x 12 ¹ / ₄ "	120	1430	12.0	11	1/5-15P	50-1000
8050SX-SLT-RC	Roller Grill, Slanted 50 Hot Dogs, <i>Gripslt</i>	35 ³ / ₄ " x 18 ⁹ / ₁₆ " x 13 ³ / ₄ "	120	1430	12.0	11	1/5-15P	50-1000
8075SXW-RC	Roller Grill, 75 Hot Dogs, <i>Gripslt</i>	35 ³ / ₄ " x 26 ³ / ₁₆ " x 12 ¹ / ₄ "	120	1920	16.0	16	1/5-20P	75-1500
8075SXW-SLT-RC	Roller Grill, Slanted 75 Hot Dogs, <i>Gripslt</i>	35 ³ / ₄ " x 26 ³ / ₁₆ " x 13 ³ / ₄ "	120	1920	16.0	16	1/5-20P	75-1500



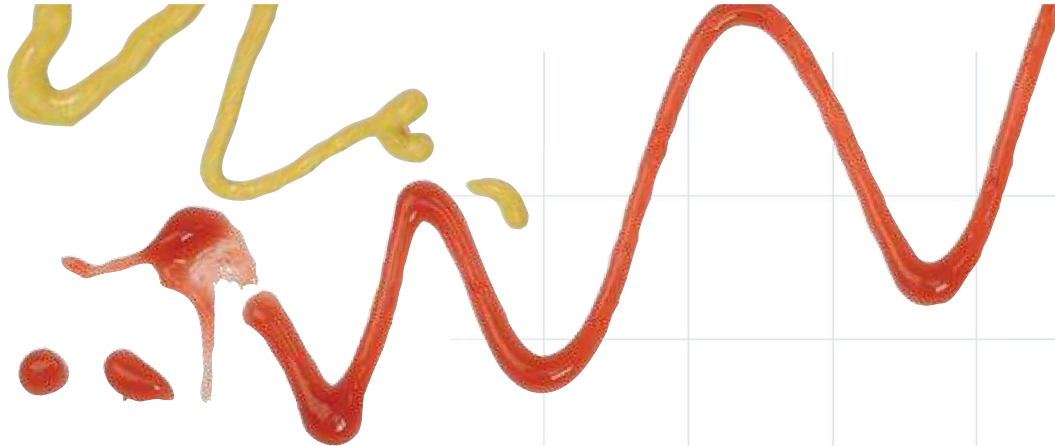

Model 8250SX-SLT
(shown with food dividers, which are available for all grills—see pg. 33)

Digital Roller Grills

Nemco's latest grill model is ideal for high-volume, self-serve establishments, where employees have little time to monitor the unit. New digital controls allow operators to place the food on the rollers, hit a button and walk away. The preprogramming then automatically sequences through the preheat, cook and hold settings to achieve a perfectly grilled product completely without supervision. For optimum roller-performance capability, look for Gripslt models that include nonstick properties with grip- and abrasion-resistant additive.

Model #	Description	Size (WxDxH)	Volts	Watts	Amps	No. of Rollers	No. of Cords	No. of 6" Franks Per Hour
8230-SLT	Roller Grill, 30 Hot Dogs, Chrome	23 ³ / ₄ " x 18 ⁵ / ₈ " x 10 ¹ / ₄ "	120	1100	9.2	11	1/5-15P	30-600
8230SX-SLT	Roller Grill, 30 Hot Dogs, Gripslt	23 ³ / ₄ " x 18 ⁵ / ₈ " x 10 ¹ / ₄ "	120	1100	9.2	11	1/5-15P	30-600
8250-SLT	Roller Grill, 50 Hot Dogs, Chrome	35 ³ / ₄ " x 18 ⁵ / ₈ " x 10 ¹ / ₄ "	120	1430	11.9	11	1/5-15P	50-1000
8250SX-SLT	Roller Grill, 50 Hot Dogs, Gripslt	35 ³ / ₄ " x 18 ⁵ / ₈ " x 10 ¹ / ₄ "	120	1430	11.9	11	1/5-15P	50-1000



roller grill w/integrated bun drawer



Model 8650SX-SLT-BW

Roller Grill with Integrated Bun Drawer **NEW!**

New all-in-one unit is designed for optimum space savings, while providing ultimate user convenience. Stays compact, and is easily portable without the need to move and set up multiple components again. Same uniform, lasting cooking performance and easy cleanup—*All models come with Gripslt for optimum roller performance.*

Model #	Description	Size (WxDxH)	Volts	Watts	Amps	No. of Rollers	No. of Cords	No. of 6" Franks Per Hour
8527SX-BW	Flat, 27 Hot Dogs, 32 Buns	22 ¹ / ₄ " x 16 ¹ / ₄ " x 12"	120	950	7.9	10	1 / 5-15P	27-540
8536SX-BW	Flat, 36 Hot Dogs, 48 Buns	29 ¹ / ₂ " x 16 ¹ / ₄ " x 12"	120	1500	12.5	10	1 / 5-15P	36-720
8545SXW-BW	Flat, 45 Hot Dogs, 64 Buns	35 ¹ / ₂ " x 16 ¹ / ₄ " x 12"	120	1800	15.0	10	1 / 5-15P	45-900
8575SX-BW	Flat, 75 Hot Dogs, 64 Buns	35 ¹ / ₂ " x 25 ³ / ₄ " x 12"	120	2880	24.0	16	2 / 5-15P	75-1500
8527SX-SLT-BW	Slanted, 27 Hot Dogs, 32 Buns	22 ¹ / ₄ " x 16 ¹ / ₄ " x 12"	120	950	7.9	10	1 / 5-15P	27-540
8536SX-SLT-BW	Slanted, 36 Hot Dogs, 48 Buns	29 ¹ / ₂ " x 16 ¹ / ₄ " x 12"	120	1500	12.5	10	1 / 5-15P	36-720
8545SXW-SLT-BW	Slanted, 45 Hot Dogs, 64 Buns	35 ¹ / ₂ " x 16 ¹ / ₄ " x 12"	120	1800	15.0	10	1 / 5-15P	45-900
8630SX-BW	Digital, Flat, 30 Hot Dogs, 32 Buns	23 ³ / ₄ " x 18 ⁵ / ₈ " x 12"	120	1100	9.2	11	1 / 5-15P	30-600
8650SX-BW	Digital, Flat, 50 Hot Dogs, 64 Buns	35 ³ / ₄ " x 18 ⁵ / ₈ " x 12"	120	1430	11.9	11	1 / 5-15P	50-1000
8630SX-SLT-BW	Digital, Slanted, 30 Hot Dogs, 32 Buns	23 ³ / ₄ " x 18 ⁵ / ₈ " x 12"	120	1100	9.2	11	1 / 5-15P	30-600
8650SX-SLT-BW	Digital, Slanted, 50 Hot Dogs, 64 Buns	35 ³ / ₄ " x 18 ⁵ / ₈ " x 12"	120	1430	11.9	11	1 / 5-15P	50-1000

bun warmers & bun boxes



Model 8075 and 8075-BW

Moist Heat Bun & Food Warmers

Keeps buns and other foods warm, fresh and ready to serve. Stainless-steel construction adds durability and makes cleaning easy. Stackable design saves space.

Model #	Description	Size (W x D x H)	Volts	Watts	Amps	Bun Capacity
8018-BW	Bun & Food Warmer	18 ¹ / ₂ " x 17 ¹ / ₂ " x 10 ⁵ / ₈ "	120	400	3.3	24
8027-BW	Bun & Food Warmer	23" x 17 ¹ / ₂ " x 10 ⁵ / ₈ "	120	450	3.8	32
8033-BW	Bun & Food Warmer	23 ⁷ / ₈ " x 22 ³ / ₁₆ " x 10 ⁵ / ₈ "	120	450	3.8	32
8036-BW	Bun & Food Warmer	30" x 17 ¹ / ₂ " x 10 ⁵ / ₈ "	120	550	4.6	48
8045N-BW	Bun & Food Warmer	23" x 26 ³ / ₄ " x 10 ⁵ / ₈ "	120	450	3.8	32
8045W-BW	Bun & Food Warmer	35 ¹ / ₂ " x 17 ¹ / ₂ " x 10 ⁵ / ₈ "	120	650	5.4	64
8055-BW	Bun & Food Warmer	35 ¹ / ₂ " x 22 ³ / ₁₆ " x 10 ⁵ / ₈ "	120	650	5.4	64
8075-BW	Bun & Food Warmer	35 ¹ / ₂ " x 25" x 10 ⁵ / ₈ "	120	650	5.4	64

220-Volt and 230-Volt CE models are also available. Call for details.





Model 8024-BW



Model 8048-BW

Bun & Food Warmers

These durable, stainless-steel, single-drawer warmers will keep the buns and other foods fresh and ready to serve. Their space-saving, stackable design makes for an easy fit most anywhere. 8024-BW has a stainless-steel, flip-down door.

Model #	Description	Size (WxDxH)	Volts	Watts	Amps	Bun Capacity
8024-BW	Bun & Food Warmer No Moist Heat	15 ³ / ₄ " x 11" x 5"	120	20	0.17	24
8048-BW	Bun & Food Warmer No Moist Heat	22" x 15 ¹ / ₄ " x 7 ¹ / ₂ "	120	108	0.9	48

220-Volt models are also available. Call for details.



Stainless Steel Bun Boxes

Each of these commercial-grade boxes provides a durable, stackable storage unit that keeps your hot-dog buns fresh. Available in a variety of sizes.

Model #	Description	Size (WxDxH)	Bun Capacity
8018-SBB	Bun Box, Stainless Steel w/Door, Fits 8018 Series	18 ³ / ₄ " x 19" x 6 ¹ / ₄ "	36
8027-SBB	Bun Box, Stainless Steel w/Door, Fits 8027 Series	22 ¹ / ₄ " x 19" x 6 ¹ / ₄ "	36
8033-SBB	Bun Box, Stainless Steel w/Door, Fits 8033 Series	24 ¹ / ₄ " x 22 ¹ / ₄ " x 6 ¹ / ₂ "	36
8036-SBB	Bun Box, Stainless Steel w/Door, Fits 8036 Series	29 ⁵ / ₈ " x 19" x 6 ¹ / ₄ "	48
8045N-SBB	Bun Box, Stainless Steel w/Door, Fits 8045N Series	22 ¹ / ₄ " x 28 ¹ / ₄ " x 6 ¹ / ₄ "	64
8045W-SBB	Bun Box, Stainless Steel w/Door, Fits 8045W Series	35 ¹ / ₂ " x 19" x 6 ¹ / ₄ "	60
8055-SBB	Bun Box, Stainless Steel w/Door, Fits 8055 Series	36" x 22 ¹ / ₄ " x 6 ¹ / ₂ "	60
8075-SBB	Bun Box, Stainless Steel w/Door, Fits 8075 Series	35 ¹ / ₂ " x 28 ¹ / ₄ " x 6 ¹ / ₄ "	96
8230-SBB	Bun Box, Stainless Steel w/Door, Fits 8230 Series	23 ³ / ₄ " x 21 ¹ / ₄ " x 6 ¹ / ₄ "	36
8250-SBB	Bun Box, Stainless Steel w/Door, Fits 8250 Series	35 ³ / ₄ " x 21 ¹ / ₄ " x 6 ¹ / ₄ "	60



Model 8045W-SBB



accessories

for roller grills



Model 8036GD

Self-Serve Guards

Polycarbonate guards (available for every grill model except the 8010 Series) offer all the advantages of the standard guards, but with a higher-impact resistance and heat resistance for exceptional durability in the busiest environments. For added convenience, operators can temporarily rest buns and such on the flat top. The guard sits firmly on top of the roller grill, yet is easily removed for cleaning.

Model #	Description	Size (W x D x H)	Fits Roller Grill
8010GD	Self-Serve Guard	16 ³ / ₈ " x 10 ¹ / ₄ " x 7"	8010 Series
8018GD	Self-Serve Guard w/Door	19" x 17 ¹ / ₄ " x 9"	8018 Series
8027GD	Self-Serve Guard w/Door	22 ³ / ₄ " x 17 ¹ / ₄ " x 9"	8027 Series
8033GD	Self-Serve Guard w/Door	24 ³ / ₈ " x 20 ¹ / ₈ " x 8 ³ / ₈ "	8033 Series
8036GD	Self-Serve Guard w/Door	30" x 17 ¹ / ₄ " x 9"	8036 Series
8045NGD	Self-Serve Guard w/Door	22 ³ / ₄ " x 26 ³ / ₄ " x 9"	8045N Series
8045WGD	Self-Serve Guard w/Door	36" x 17 ¹ / ₄ " x 9"	8045W Series
8055GD	Self-Serve Guard w/Door	36 ³ / ₈ " x 20 ¹ / ₈ " x 8 ³ / ₈ "	8055 Series
8075GD	Self-Serve Guard w/Door	36" x 26 ³ / ₄ " x 9"	8075 Series
8230GD	Self-Serve Guard w/Door	24 ³ / ₁₆ " x 19 ³ / ₄ " x 9"	8230 Series
8250GD	Self-Serve Guard w/Door	36 ³ / ₁₆ " x 19 ³ / ₄ " x 9"	8250 Series
8230DGD	Self-Serve Guard w/Pass-Thru	24 ³ / ₁₆ " x 19 ³ / ₄ " x 9"	8230 Series
8250DGD	Self-Serve Guard w/Pass-Thru	36 ³ / ₁₆ " x 19 ³ / ₄ " x 9"	8250 Series



Model 8250-CGD



Canopy Sneeze Guards

Keep your Roller Grill covered with the added convenience of these pass-through canopy guards. The open design, with no doors, makes it easy to load the grill from the operator side, while still allowing access to the food from the customer side.

Model #	Description	Size (W x D x H)	Fits Roller Grill
8018-CGD	Canopy Sneeze Guard	19" x 17 ¹ / ₂ " x 8 ³ / ₄ "	8018 Series
8027-CGD	Canopy Sneeze Guard	22 ³ / ₄ " x 17 ¹ / ₂ " x 8 ³ / ₄ "	8027 Series
8036-CGD	Canopy Sneeze Guard	30" x 17 ¹ / ₂ " x 8 ³ / ₄ "	8036 Series
8045N-CGD	Canopy Sneeze Guard	22 ³ / ₄ " x 27" x 8 ³ / ₄ "	8045N Series
8045W-CGD	Canopy Sneeze Guard	36" x 17 ¹ / ₂ " x 8 ³ / ₄ "	8045W Series
8075-CGD	Canopy Sneeze Guard	36" x 27" x 8 ³ / ₄ "	8075 Series
8230-CGD	Canopy Sneeze Guard	24 ¹ / ₄ " x 19 ⁷ / ₈ " x 8 ³ / ₄ "	8230 Series
8250-CGD	Canopy Sneeze Guard	36 ¹ / ₄ " x 19 ⁷ / ₈ " x 8 ³ / ₄ "	8250 Series



Tongs With Holder

Like losing the remote for the TV, no one likes it when the roller-grill tongs go missing. Consider the problem solved with this convenient add-on tong-holder combo. Fits any grill model and features a super-elastic cord that allows for easy use without risk that the tongs walk away.

Model #	Description
80650	Tong Holder w/Tongs



Back view

Model 8300

suggested uses

Perfect for convenience stores and concession areas short on space. Also great for informal catering events, bars, pool halls, bowling alleys and other public-gathering places.

Hot Dog Steamers

You can't beat the moneymaking magic of a classic ballpark hot dog. Nemco's countertop hot dog steamer cooks 'em up plump and juicy, and adds merchandising appeal to attract hungry customers. Smart design uses steam to keep buns on the upper bun rack moist and fresh. User-friendly features minimize the need for operator attention. Best of all, hot dogs can be ready to serve in as few as 10 minutes!

Model #	Description	Size (W x D x H)	Volts	Watts	Amps
8300	Hot Dog Steamer, 7 1/2 qt. Water Reservoir 150 Hot Dogs, 30 Buns, Low-Water-Level Indicator Light	13 1/2" x 15" x 18"	120	800	6.7
8301	Hot Dog Steamer, 7 1/2 qt. Water Reservoir 150 Hot Dogs, 30 Buns, No Low-Water-Level Indicator Light	13 1/2" x 15" x 18"	120	800	6.7

220-Volt and 230-Volt CE models are also available. Call for details.



Mini Cart

Cash in on a real fan favorite with the fun and character of these mini hot-dog cart merchandisers that fit right on your countertop or bar. Fully adjustable heating controls let you easily set and monitor temperatures. Inserts and accessories allow you to adapt to changing menu items. Standard models steam and hold as many hot dogs as a New York City street cart!

Model #	Description	Size (W x D x H)	Volts	Watts	Amps
6550-DW	Mini Cart, Blue	23 7/8" x 14 5/8" x 10 1/2"*	120	1500	12.5

*Height with umbrella is 46 1/2". Please specify pan configuration option number below when ordering. Additional pan configurations available. Call for details.

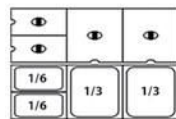

Pan configuration—option 1

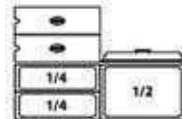

Pan configuration—option 2

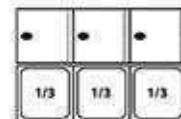

Pan configuration—option 3



To identify the model numbers of the appropriate accessories for your grill, read across from the model number of the grill you choose.

Grill Series #	Bun Warmers (Stainless Steel)	Divider Kits	Bun Boxes	Self-Serve Guards	Canopy Guards
8010	8024-BW	—	8018-SBB	8010GD	—
8018	8018-BW	—	8018-SBB	8018GD	8018-CGD
8027	8027-BW, 8048-BW	80435-27	8027-SBB	8027GD	8027-CGD
8033	8033-BW	—	8033-SBB	8033GD	—
8036	8036-BW	80435-36	8036-SBB	8036GD	8036-CGD
8045N	8045N-BW	80435-45N	8045N-SBB	8045NGD	8045N-CGD
8045W	8045W-BW	80435-45W	8045W-SBB	8045WGD	8045W-CGD
8055	8055-BW	—	8055-SBB	8055GD	—
8075	8075-BW	80435-75	8075-SBB	8075GD	8075-CGD
8230	—	80440-30	8230-SBB	8230GD, 8230DGD	8230-CGD
8250	—	80440-50	8250-SBB	8250GD, 8250DGD	8250-CGD

sandwich
press

paniniPro

high-speed sandwich press

VENTLESS!

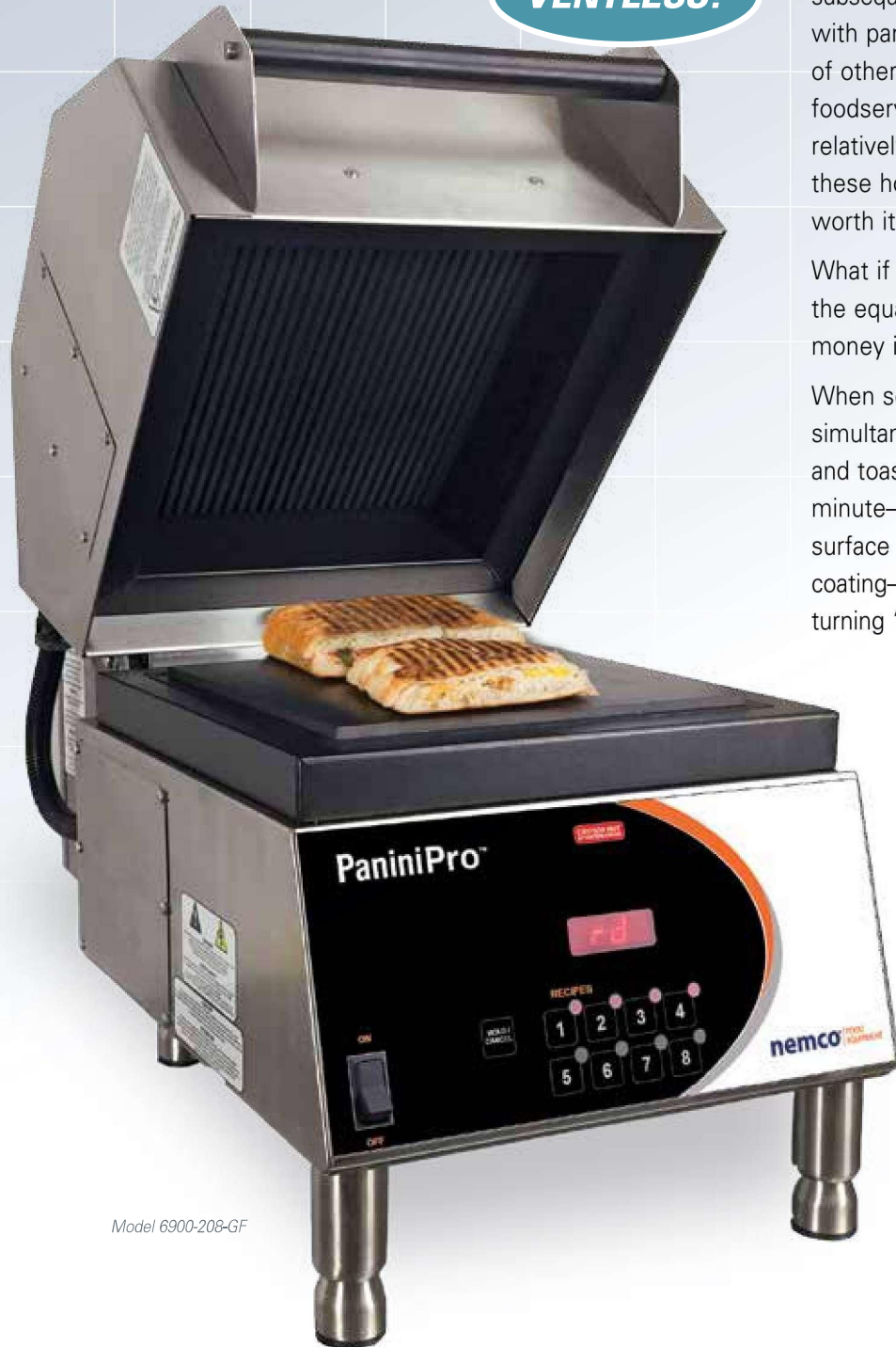

Model 6900-208-GF

Place an Order for "Wow"

Given the high demand—and subsequent high margin—associated with paninis, wraps and all sorts of other grilled-style sandwiches, foodservice operators look at the relatively tedious task of preparing these hot sellers and say, "It's worth it." But what if. . . ?

What if tedious wasn't part of the equation? How much more money is there to be made?

When seeing how the PaniniPro™ simultaneously heats the protein and toasts the bread in a hot minute—on a durable aluminum surface with a tough nonstick coating—these same operators are turning "what if" into a big "wow."

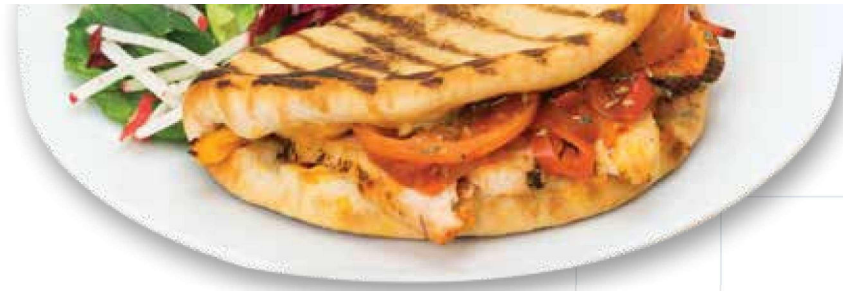

suggested uses

This compact workhorse brings a whole new dynamic to sandwich shops, coffee shops, c-stores, fast-casual chains and other retail food operations looking to capitalize on the hot-sandwich trend. It takes little time and space to expand your menu and serve toasty paninis, ciabatta-bread sandwiches, flatbread sandwiches, quesadillas, burritos, breakfast sandwiches, Cuban wraps and more.

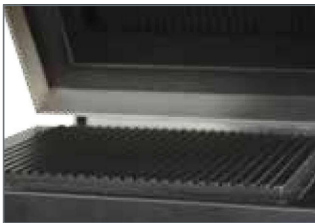

Features—The top and bottom plates are available with grooved or flat surfaces in your choice of pairings. A spring-loaded upper plate moves to ensure uniform plate-to-food contact with sandwiches of variable thickness. All food-contact surfaces have an engineered nonstick coating.



8 push-button electronic controls and digital display make operation extremely simple.

PaniniPro™ High-Speed Sandwich Press **NEW!**

Doing the conventional panini press one better, the PaniniPro high-speed sandwich press gives super-busy and space-restrictive foodservice operations exactly what they need to break into the hot-sandwich market. With simultaneous conduction and microwave heating, sandwiches are ready in about 60 seconds. Programmable, push-button electronic controls ensure heating consistency from sandwich to sandwich, employee to employee, while a built-in USB port makes reprogramming for a menu change a simple process.

Model #	Description	Size (W x D x H)	Volts	Watts	Amps
6900-208-GF	Grooved Top, Flat Bottom	14½" x 31" x 29"	208	2,000	28.0
6900-208-GG	Grooved Top, Grooved Bottom	14½" x 31" x 29"	208	2,000	28.0
6900-208-FF	Flat Top, Flat Bottom	14½" x 31" x 29"	208	2,000	28.0
6900-240-GF	Grooved Top, Flat Bottom	14½" x 31" x 29"	240	2,000	24.0
6900-240-GG	Grooved Top, Grooved Bottom	14½" x 31" x 29"	240	2,000	24.0
6900-240-FF	Flat Top, Flat Bottom	14½" x 31" x 29"	240	2,000	24.0



Nemco Food Equipment's 6900-model family has been evaluated and found to comply with Section 59 of UL710B, the Standard for Recirculating Systems, formerly Section 14 of UL197, 8th Edition, Supplement SB, and paragraph 4.1.1.2 of NFPA96, the Standard for Ventilation Control and Fire Protection of Commercial Cooking Appliances.



Arriving preprogrammed with four standard heating cycles, the PaniniPro high-speed sandwich press also includes a flash drive with a user-friendly software capability that makes it easy to change the heating cycles in tandem with your sandwich menu.



Every PaniniPro comes with a spatula (model 48826) that's both flexible and durable, yet won't harm the integrity of the plates' nonstick coating.

paniniPro : features

Stainless-steel body construction is commercial tough and super-easy to keep clean

Top and bottom plates are available with either grooved or flat surfaces. Specify the configuration you prefer (unit shown with grooved top and flat bottom).

Both the upper and lower plates can be independently set to temperatures of up to 500° F

To maximize your productivity, the 110 square-inch (10.5" x 10.5") heating surface accommodates four standard-sized Texas-toast sandwiches

4-inch heavy-duty stainless-steel legs provide stability and the necessary clearance for easy counter cleaning

A spring-loaded upper plate moves to ensure uniform plate-to-food contact with sandwiches of variable thicknesses

Engineered nonstick coating, applied to all food-contact surfaces, makes sandwich flipping & handling easy and simplifies cleanup

8 push-button electronic controls and digital display make operation extremely simple



food warming equipment

bulb warmers



Model 6000A-1A



Model 6000A-2
w/ 66091, 66089



Model 6008-4

suggested uses

Keep plated foods at proper serving temperatures, including pies, breads, and other baked goods. Also great for hot appetizers and side dishes, such as chicken fingers, French fries, poppers and fried shrimp.



Model 6004-4

Freestanding Infrared Bulb Warmers

Hold baked, fried, steamed or broiled foods at ready-to-eat temperatures and still keep the food's appetizing appearance over time. Attractive, timeless reflector-hood design fits every interior. Custom configurations available with different bulbs (see optional accessories below) and colored reflector hoods (see color swatches on opposite page).

Model #	Description	Volts	Watts
6000A-1*	Single Bulb, Adjustable Height	120	250
6000A-1A*	Single Bulb, Adjustable Height, Compact	120	250
6000A-2*	Two Bulb, Adjustable Height, Grey	120	500
6000A-2B*	Two Bulb, Adjustable Height, Black	120	500
6000A-2TP*	Two Bulb Heat Lamp w/Pan & Screen Set	120	500
6000A-3*	Three Bulb, Adjustable Height	120	750

220-Volt models also available. Call for details.

Clamp-On Units

6004-1	Single Bulb, Clamp	120	250
6004-2	Two Bulb, Clamp	120	500
6004-4	Single Bulb, Adjustable Gooseneck, Grey	120	250

Counter Units

6008-2	Two Bulb Counter Unit	120	500
6008-3	Three Bulb Counter Unit	120	750
6008-4	Four Bulb Counter Unit	120	1000
6008-5	Five Bulb Counter Unit	120	1250
6008-6	Six Bulb Counter Unit	120	1500
6008-7	Seven Bulb Counter Unit	120	1750
6008-8	Eight Bulb Counter Unit	120	2000
6009-2*	Two Bulb Counter Unit, w/Tray	120	500
6009-3*	Three Bulb Counter Unit, w/Tray	120	750
6009-4*	Four Bulb Counter Unit, w/Tray	120	1000
6009-5*	Five Bulb Counter Unit, w/Tray	120	1250
6009-6*	Six Bulb Counter Unit, w/Tray	120	1500

Optional Accessories

Model #	Description
66089	Pan and Screen Set, 12"x 20"
66091	Tray for 6000A-1 & 2





For permanent serving lines in cafeterias and other institutional settings.



Model 6002



black

Suspended Infrared Bulb Warmers

Model #	Description	Volts	Watts
Ceiling-Mount Models			
6002	Single Bulb, 6' Cord	120	250
6003	Single Bulb, 4' Tube	120	250

Suspension Bar, Chain-Hung Models

6006-2	Two Bulb, Single Row	120	500
6006-3	Three Bulb, Single Row	120	750
6006-4	Four Bulb, Single Row	120	1000
6006-5	Five Bulb, Single Row	120	1250
6006-6	Six Bulb, Single Row	120	1500
6006-7	Seven Bulb, Single Row	120	1750
6006-8	Eight Bulb, Single Row	120	2000



Model 6015-DP

Model 6016-C

Carving Station Bulb Warmers

Combines a 250-watt infrared bulb with a convenient, NSF high-density polyethylene cutting board. Wooden carving board also available. Adjustable, 30-inch-high, flexible gooseneck. Cutting board detaches for easy cleanup.

Model #	Description	Volts	Watts
6015	Single Bulb, Polyethylene Base, Grey	120	250
6015-DP	Single Bulb, Polyethylene Base w/Deeper Groove on Base, Heat Lamp Centered	120	250
6016	Single Bulb, Wood Base, Grey	120	250

Optional Accessories

Model #	Description
66103	Case of 12, 250-Watt Bulbs (Clear)
66104	Case of 12, 250-Watt Bulbs (Red)
66118	Case of 12, 250-Watt Bulbs (Clear, Shatter-Resistant)



suggested uses

The perfect choice for serving moist, juicy slices of roast beef, prime rib, turkey, ham, leg of lamb and other large cuts at buffets and server stations.

infrared strip heaters

On-Off Switch

The Nemco line is as expansive as any other line on the market!—boasting more model and feature options than ever, including units with single- or dual-bulb warming, complementary incandescent showcase lighting, remote-control, cord-and-plug power and more. All hold foods at optimum serving temperature without drying or overcooking to ensure better-tasting foods and better-looking presentations. Hanging, base-mounted and pass-through designs fit most locations, as well as permanent and temporary requirements. Durable aluminum shell for easy cleanup. Available with infinite temperature control for varying low-, medium- and high-heat settings.

Single Element

Model #	Description	Volts	Watts
6150-24	24" Strip Heater, Single	120	500
6150-24-208	24" Strip Heater, Single	208	500
6150-24-240	24" Strip Heater, Single	240	500
6150-36	36" Strip Heater, Single	120	850
6150-36-208	36" Strip Heater, Single	208	850
6150-36-240	36" Strip Heater, Single	240	850
6150-48	48" Strip Heater, Single	120	1100
6150-48-208	48" Strip Heater, Single	208	1100
6150-48-240	48" Strip Heater, Single	240	1100
6150-60	60" Strip Heater, Single	120	1400
6150-60-208	60" Strip Heater, Single	208	1400
6150-60-240	60" Strip Heater, Single	240	1400
6150-72	72" Strip Heater, Single	120	1725
6150-72-208	72" Strip Heater, Single	208	1725
6150-72-240	72" Strip Heater, Single	240	1725

Single Element with Lights

6150-24-SL	24" Strip Heater, Single, w/Lights	120	580
6150-24-SL-208	24" Strip Heater, Single, w/Lights	208	580
6150-24-SL-240	24" Strip Heater, Single, w/Lights	240	580
6150-36-SL	36" Strip Heater, Single, w/Lights	120	970
6150-36-SL-208	36" Strip Heater, Single, w/Lights	208	970
6150-36-SL-240	36" Strip Heater, Single, w/Lights	240	970
6150-48-SL	48" Strip Heater, Single, w/Lights	120	1220
6150-48-SL-208	48" Strip Heater, Single, w/Lights	208	1220
6150-48-SL-240	48" Strip Heater, Single, w/Lights	240	1220
6150-60-SL	60" Strip Heater, Single, w/Lights	120	1560
6150-60-SL-208	60" Strip Heater, Single, w/Lights	208	1560
6150-60-SL-240	60" Strip Heater, Single, w/Lights	240	1560
6150-72-SL	72" Strip Heater, Single, w/Lights	120	1885



Dual Element

Model #	Description	Volts	Watts
6150-24-D	24" Strip Heater, Dual	120	1000
6150-24-D-208	24" Strip Heater, Dual	208	1000
6150-24-D-240	24" Strip Heater, Dual	240	1000
6150-36-D	36" Strip Heater, Dual	120	1700
6150-36-D-208	36" Strip Heater, Dual	208	1700
6150-36-D-240	36" Strip Heater, Dual	240	1700
6150-48-D-208	48" Strip Heater, Dual	208	2200
6150-48-D-240	48" Strip Heater, Dual	240	2200
6150-60-D-208	60" Strip Heater, Dual	208	2800
6150-60-D-240	60" Strip Heater, Dual	240	2800
6150-72-D-208	72" Strip Heater, Dual	208	3450
6150-72-D-240	72" Strip Heater, Dual	240	3450

Dual Element with Lights

6150-24-DL	24" Strip Heater, Dual, w/Lights	120	1080
6150-24-DL-208	24" Strip Heater, Dual, w/Lights	208	1080
6150-24-DL-240	24" Strip Heater, Dual, w/Lights	240	1080
6150-36-DL	36" Strip Heater, Dual, w/Lights	120	1780
6150-36-DL-208	36" Strip Heater, Dual, w/Lights	208	1780
6150-36-DL-240	36" Strip Heater, Dual, w/Lights	240	1780
6150-48-DL-208	48" Strip Heater, Dual, w/Lights	208	2320
6150-48-DL-240	48" Strip Heater, Dual, w/Lights	240	2320
6150-60-DL-208	60" Strip Heater, Dual, w/Lights	208	2960
6150-60-DL-240	60" Strip Heater, Dual, w/Lights	240	2960
6150-72-DL-208	72" Strip Heater, Dual, w/Lights	208	3610
6150-72-DL-240	72" Strip Heater, Dual, w/Lights	240	3610



Model 6150-72-DL, Dual with Lights

Infinite Control

Single Element, Infinite Control

Model #	Description	Volts	Watts
6151-24	24" Infinite Control, Single	120	500
6151-24-208	24" Infinite Control, Single	208	500
6151-24-240	24" Infinite Control, Single	240	500
6151-36	36" Infinite Control, Single	120	850
6151-36-208	36" Infinite Control, Single	208	850
6151-36-240	36" Infinite Control, Single	240	850
6151-48	48" Infinite Control, Single	120	1100
6151-48-208	48" Infinite Control, Single	208	1100
6151-48-240	48" Infinite Control, Single	240	1100
6151-60	60" Infinite Control, Single	120	1400
6151-60-208	60" Infinite Control, Single	208	1400
6151-60-240	60" Infinite Control, Single	240	1400
6151-72	72" Infinite Control, Single	120	1725
6151-72-208	72" Infinite Control, Single	208	1725
6151-72-240	72" Infinite Control, Single	240	1725



Dual Element, Infinite Control

Model #	Description	Volts	Watts
6151-24-D	24" Infinite Control, Dual	120	1000
6151-24-D-208	24" Infinite Control, Dual	208	1000
6151-24-D-240	24" Infinite Control, Dual	240	1000
6151-36-D	36" Infinite Control, Dual	120	1700
6151-36-D-208	36" Infinite Control, Dual	208	1700
6151-36-D-240	36" Infinite Control, Dual	240	1700
6151-48-D-208	48" Infinite Control, Dual	208	2200
6151-48-D-240	48" Infinite Control, Dual	240	2200
6151-60-D-208	60" Infinite Control, Dual	208	2800
6151-60-D-240	60" Infinite Control, Dual	240	2800



Cord & Plug Included

Single Element, On-Off Switch

Model #	Description	Volts	Watts
6150-24-CP	24" Strip Heater, w/Cord & Plug	120	500
6150-36-CP	36" Strip Heater, w/Cord & Plug	120	850
6150-48-CP	48" Strip Heater, w/Cord & Plug	120	1100
6150-60-CP	60" Strip Heater, w/Cord & Plug	120	1400
6150-72-CP	72" Strip Heater, w/Cord & Plug	120	1725



Single Element, Infinite Control

Model #	Description	Volts	Watts
6151-24-CP	24" Infinite Control, w/Cord & Plug	120	500
6151-36-CP	36" Infinite Control, w/Cord & Plug	120	850
6151-48-CP	48" Infinite Control, w/Cord & Plug	120	1100
6151-60-CP	60" Infinite Control, w/Cord & Plug	120	1400
6151-72-CP	72" Infinite Control, w/Cord & Plug	120	1725



infrared strip heaters

Remote Control

Single Element, Remote Control

Model #	Description	Volts	Watts
6155-24	24" Remote, Single	120	500
6155-24-208	24" Remote, Single	208	500
6155-24-240	24" Remote, Single	240	500
6155-36	36" Remote, Single	120	850
6155-36-208	36" Remote, Single	208	850
6155-36-240	36" Remote, Single	240	850
6155-48	48" Remote, Single	120	1100
6155-48-208	48" Remote, Single	208	1100
6155-48-240	48" Remote, Single	240	1100
6155-60	60" Remote, Single	120	1400
6155-60-208	60" Remote, Single	208	1400
6155-60-240	60" Remote, Single	240	1400
6155-72	72" Remote, Single	120	1725
6155-72-208	72" Remote, Single	208	1725
6155-72-240	72" Remote, Single	240	1725

Single Element, Remote Control with Lights

6155-24-SL	24" Remote, Single, w/Lights	120	580
6155-24-SL-208	24" Remote, Single, w/Lights	208	580
6155-24-SL-240	24" Remote, Single, w/Lights	240	580
6155-36-SL	36" Remote, Single, w/Lights	120	930
6155-36-SL-208	36" Remote, Single, w/Lights	208	930
6155-36-SL-240	36" Remote, Single, w/Lights	240	930
6155-48-SL	48" Remote, Single, w/Lights	120	1220
6155-48-SL-208	48" Remote, Single, w/Lights	208	1220
6155-48-SL-240	48" Remote, Single, w/Lights	240	1220
6155-60-SL	60" Remote, Single, w/Lights	120	1560
6155-60-SL-208	60" Remote, Single, w/Lights	208	1560
6155-60-SL-240	60" Remote, Single, w/Lights	240	1560
6155-72-SL	72" Remote, Single, w/Lights	120	1885
6155-72-SL-208	72" Remote, Single, w/Lights	208	1885
6155-72-SL-240	72" Remote, Single, w/Lights	240	1885



Dual Element, Remote Control

Model #	Description	Volts	Watts
6155-24-D	24" Remote, Dual	120	1000
6155-24-D-208	24" Remote, Dual	208	1000
6155-24-D-240	24" Remote, Dual	240	1000
6155-36-D	36" Remote, Dual	120	1700
6155-36-D-208	36" Remote, Dual	208	1700
6155-36-D-240	36" Remote, Dual	240	1700
6155-48-D-208	48" Remote, Dual	208	2200
6155-48-D-240	48" Remote, Dual	240	2200
6155-60-D-208	60" Remote, Dual	208	2800
6155-60-D-240	60" Remote, Dual	240	2800
6155-72-D-208	72" Remote, Dual	208	3450

Dual Element, Remote Control with Lights

6155-24-DL	24" Remote, Dual, w/Lights	120	1080
6155-24-DL-208	24" Remote, Dual, w/Lights	208	1080
6155-24-DL-240	24" Remote, Dual, w/Lights	240	1080
6155-36-DL	36" Remote, Dual, w/Lights	120	1780
6155-36-DL-208	36" Remote, Dual, w/Lights	208	1780
6155-36-DL-240	36" Remote, Dual, w/Lights	240	1780
6155-48-DL-208	48" Remote, Dual, w/Lights	208	2320
6155-48-DL-240	48" Remote, Dual, w/Lights	240	2320
6155-60-DL-208	60" Remote, Dual, w/Lights	208	2960
6155-60-DL-240	60" Remote, Dual, w/Lights	240	2960
6155-72-DL-208	72" Remote, Dual, w/Lights	208	3610
6155-72-DL-240	72" Remote, Dual, w/Lights	240	3610



Model 6155-48-SL, Features Lights

suggested uses

Hold foods at proper temperatures until you are ready to serve. A favorite for French fries, rice dishes, baked potatoes, fried chicken, pizza and large pans of food. Also works well as a plate or cup warmer.



Model 6152-24
w/ 66089

Heater with Base Model

Model #	Description	Volts	Watts
6152-24	24" Steel Heater on Base	120	500

Optional Accessories

Model #	Description
66089	Pan and Screen Set, 12" x 20"
66091	Tray for 6152-24
66099	Wire Leg Kit—Height 16"



Model 69008

Model 69008-2

Model 69007

Model 69007-2

Remote-Control Boxes

Remotes available for single and dual units, and your choice of an on-off toggle switch or infinite temperature control.

Model #	Description	Volts
69007	1- On-Off Power Switch, 1- Pilot Light (indicates element on)	120
69008	1- On-Off Power Switch, 1- Pilot Light (indicates element on), 1- Infinite Control (adjustable temperature)	120
69007-2	2- On-Off Power Switches (elements), 1- On-Off Power Switch (lights), 2- Pilot Lights (indicates elements on)	120
69008-2	1- On-Off Power Switch, 2- Pilot Lights (indicates elements on), 2- Infinite Control (adjustable temperature)	120

208/240-Volt models are also available. Add -240 to model number when ordering.

Mounting Options



Model 6150-24
w/ 66099

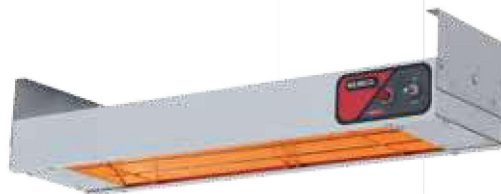

Model 6150-24, with hanging brackets
(hanging brackets are included in all models)

warmers

countertop cookers & warmers

suggested uses

Ideal for serving vegetables, stir-fry, casseroles, lasagna and other items in buffet lines and catering applications. Accepts a 12" x 20" full-size pan or fractional-size pans.



Model 6055A



Model 6055A-43

Countertop Warmers

Add side dishes and entrées to existing buffet lines or create entirely new temporary buffet lines quickly and easily with Nemco's full-size countertop warmers. You'll enjoy greater menu flexibility and the ability to respond efficiently to changing menu requirements. Plus the reliable adjustable thermostat helps ensure that food held in serving lines is always within your food-safety temperature guidelines. Unique heating-element design provides even heat distribution to prevent "hot spots." Heavy-duty stainless-steel well.

Model #	Description	Size (W x D x H)	Volts	Watts
6055A*	Full-Size Warmer	14 ⁵ / ₈ " x 23 ¹ / ₂ " x 9"	120	1200
6055A-CW	Full-Size Cooker & Warmer	14 ⁵ / ₈ " x 23 ¹ / ₂ " x 10 ¹ / ₂ "	120	1500
6055A-43	1/3 Size Warmer	14 ⁵ / ₈ " x 30 ⁵ / ₈ " x 10 ¹ / ₂ "	120	1500

Optional Accessories

Model#	Description
66092	Two-Hole Adapter Plates for One 7 Quart & One 11 Quart Inset (Fits 6055A)
66093	Two-Hole Adapter Plates for Two 7 Quart Insets
66095	20" Adapter Bar
66096	12" Adapter Bar
66097	6" Adapter Bar
67763	Two-Hole Adapter Plates for Two 11 Quart Insets (Fits 6055A-43)
67860	Three-Hole Adapter Plates for Three 4 Quart Insets (Fits 6055A)
68591	Three-Hole Adapter Plates for Three 7 Quart Insets (Fits 6055A-43)
68592	Four-Hole Adapter Plates for Four 4 Quart Insets (Fits 6055A-43)

All Nemco cooker/warmers are listed NSF/ANSI Standard 4, making them certified "rethermalization equipment." 230-Volt CE models are also available. Call for details.



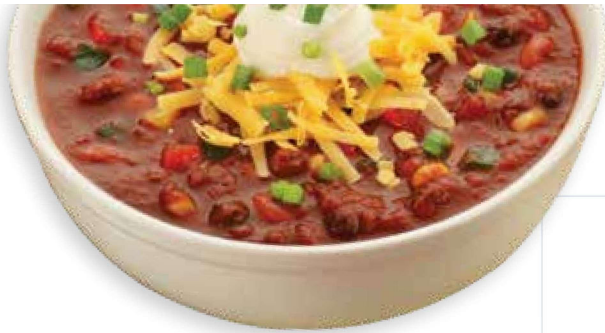

suggested uses

Attractive enough for serving lines. Round warmers keep soups, gravies, BBQ sauce, hot dressings and dessert toppings warm and appetizing.



Model 6120A-ICL



No drip rim.



Model 6100A-ICL

Countertop Cookers & Warmers

Unique heating-element design provides even distribution to prevent "hot spots." Twin warmers have separate thermostats and balanced heat systems for maximum control and convenience. Stainless-steel construction ensures durability, prevents pitting and staining, and stands up to detergents, hard water and corrosion.

Round Warmers

Model #	Description	Size (W x D x H)	Volts	Watts
6100A	7 Quart	10" x - x 9 ⁵ / ₈ "	120	550
6100A-ICL	7 Quart w/Inset, Cover, Ladle	10" x - x 13 ¹ / ₂ "	120	550
6101A	11 Quart	12 ¹ / ₂ " x - x 9 ⁵ / ₈ "	120	750
6101A-ICL	11 Quart w/Inset, Cover, Ladle	12 ¹ / ₂ " x - x 13 ¹ / ₂ "	120	750

Round Cooker Warmers

6102A	7 Quart	10" x - x 9 ⁵ / ₈ "	120	1050
6102A-ICL	7 Quart w/Inset, Cover, Ladle	10" x - x 13 ¹ / ₂ "	120	1050
6103A	11 Quart	12 ¹ / ₂ " x - x 9 ⁵ / ₈ "	120	1250
6103A-ICL	11 Quart w/Inset, Cover, Ladle	12 ¹ / ₂ " x - x 13 ¹ / ₂ "	120	1250

Countertop Warmers

6110A	4 Quart, Single Well	8 ⁷ / ₈ " x 9 ³ / ₄ " x 9 ⁷ / ₈ "	120	350
6110A-ICL	4 Quart w/Inset, Cover, Ladle	8 ⁷ / ₈ " x 9 ³ / ₄ " x 13 ¹ / ₂ "	120	350
6120A	4 Quart, Twin Well	18 ¹ / ₂ " x 10" x 9 ⁷ / ₈ "	120	700
6120A-ICL	4 Quart w/Inset, Cover, Ladle	18 ¹ / ₂ " x 10" x 13 ¹ / ₂ "	120	700
6120A-CW	4 Quart Cooker/Warmer, Twin Well	18 ¹ / ₂ " x 10" x 9 ⁷ / ₈ "	120	1000
6120A-CW-ICL	4 Quart Cooker/Warmer, Twin Well w/Inset, Cover, Ladle	18 ¹ / ₂ " x 10" x 13 ¹ / ₂ "	120	1000

Optional Accessories

Model #	Description	Fits Models
66088-2	Inset, Cover and Ladle Set (4 quart)	6110A & 6120A
66088-8	Inset, Cover and Ladle Set (7 quart)	6100A & 6102A
66088-10	Inset, Cover and Ladle Set (11 quart)	6101A & 6103A

All Nemco cooker/warmers are listed NSF/ANSI Standard 4, making them certified "rethermalization equipment." 230-Volt CE models are also available. Call for details.



suggested uses

Heat, refresh and serve hundreds of hot foods, from blueberry muffins, to beef stew, to Mexican burritos, to lobster dinners. You name it. If it's leftover or frozen, it can taste like it's freshly cooked once again.



Fresh-O-Matic by Nemco

Instantly thermalize your precooked and frozen baked goods, meats, seafood, veggies, pasta and more with the reliable, easy-to-use Fresh-O-Matic by Nemco. When it comes to food quality, you can't beat fresh-made. But with the Fresh-O-Matic, you can match it—uses super-hot steam to instantly return moist heat to cold, precooked foods!

Model #	Description	Size (WxDxH)	Volts	Watts	Amps
6625B	Fresh-O-Matic by Nemco	16 ¹ / ₂ " x 12" x 11 ⁵ / ₈ "	120	1500	12.5



suggested uses

Primed for virtually any cold foods you want to zap into a hot, fresh, plate-ready state—instantly! Ideal for buns, rolls, breads and other baked goods, and just perfect for tortillas. Great for melting cheese or reheating precooked seafood, meats, pasta, fruits, veggies and more!



Super Shot Countertop Steamer

This powerful little appliance could wind up being one of the most versatile tools in your entire kitchen. The Super Shot reheats foods and restores their fresh-made flavor in seconds! Make day-old breads, buns and baked goods taste like they just came from the oven. It's ridiculously easy to operate. Simply plug it into a standard outlet, fill the reservoir with tap water, then use the push-button to deliver a pulse of amazing steam. Made of commercial-grade stainless steel and cast aluminum.

Model #	Description	Size (WxDxH)	Volts	Watts	Amps
6600	Super Shot Steamer	16 ¹ / ₂ " x 17 ¹ / ₄ " x 8 ¹ / ₄ "	120	1800	15.0

230-Volt models are also available. Call for details.





suggested uses

Use one Nemco Mini Steam Table in place of several individual units to keep soups, sauces, gravies, stews and other like foods at the perfect temperature. Adapter plates provide maximum versatility on serving lines, allowing complete meal presentations, such as ribs with dipping sauce, mashed potatoes and gravy, plus many other side dishes.

Mini Steam Table

Mix-and-match adapter plates allow for more than six configurations to meet almost any serving need. Extra deep wells hold the largest pots and pans. Temperature range of 100°F to 200°F. Stainless-steel construction ensures durability and resists pitting and staining. Features "power on" indicator lights and back-mounted, 6-foot cord.

Model #	Size (W x D x H)	Volts	Watts	Amps
6060A	27 ¹ / ₂ " x 24 ¹ / ₂ " x 12 ¹ / ₂ "	120	1800	15.0

Adapter Plates and Optional Accessories

Model #	Description
67339	Holds Two 12" x 20" Steam Table Pans
67409	Holds Four 7 ¹ / ₄ Quart Round Inset Pans
67410	Holds Two 11 Quart and Two 4 ¹ / ₈ Quart Round Inset Pans
67411	Holds One 12" x 20" Steam Table Pan and Two 7 ¹ / ₄ Quart Round Inset Pans
67412	Holds One 11 Quart Round Inset Pan, Two 7 ¹ / ₄ Quart Round Inset Pans and One 4 ¹ / ₈ Quart Round Inset Pan
67413	Holds One 12" x 20" Steam Table Pan and Two 4 ¹ / ₈ Quart Round Inset Pans
66785	Set of Four Stainless Steel, Adjustable Legs



Adapter Plates

for Model 6060A

1 full
2 halves
3 thirds
4 quarters

1 full
2 halves
3 thirds
4 quarters

Model 67339

7¹/₄ qt

7¹/₄ qt

7¹/₄ qt

7¹/₄ qt

Model 67409

4¹/₈ qt

11 qt

11 qt

4¹/₈ qt

Model 67410

1 full
2 halves
3 thirds
4 quarters

7¹/₄ qt

7¹/₄ qt

Model 67411

11 qt

7¹/₄ qt

4¹/₈ qt

7¹/₄ qt

Model 67412

1 full
2 halves
3 thirds
4 quarters

4¹/₈ qt

4¹/₈ qt

Model 67413

Adapter plate dimensions

4¹/₈" qt. = 6³/₈" dia.

7¹/₄" qt. = 8¹/₂" dia.

11" qt. = 10¹/₂" dia.

hot plates



Model 6310-1



Model 6310-2



Model 6310-3-240



Model 6311-2-240



Model 6311-1-240

Hot Plates

Solid-top, cast-iron French burners heat up quickly and evenly, with six heat settings that can take you from a simmer to a boil in minutes. Horizontal and vertical configurations with one-, two- and four-burner setups fit most spaces. Multiple burners offer heating versatility. Right burner on the horizontal is a 1500-watt cooker, while the 500-watt left burner is perfect for warming. Vertical units have the cooker in the front. All models equipped with adjustable feet for added convenience.

Single Burners

Model #	Description	Size (W x D x H)	Volts	Watts	Amps
6310-1	Single Burner	12" x 13 ¹ / ₂ " x 5 ¹ / ₈ "	120	1500	12.5
6310-1-240	Single Burner	12" x 13 ¹ / ₂ " x 5 ¹ / ₈ "	240	2000	8.3

Double Burners

6310-2	Horizontal Double Burner	24 ¹ / ₈ " x 13 ¹ / ₂ " x 5 ¹ / ₈ "	120	2000	16.7
6310-2-240	Horizontal Double Burner	24 ¹ / ₈ " x 13 ¹ / ₂ " x 5 ¹ / ₈ "	240	3000	12.5
6310-3	Vertical Double Burner	12 ¹ / ₈ " x 25 ¹ / ₂ " x 5 ¹ / ₈ "	120	2000	16.7
6310-3-240	Vertical Double Burner	12 ¹ / ₈ " x 25 ¹ / ₂ " x 5 ¹ / ₈ "	240	3000	12.5
6311-1-240	Raised Vertical Double Burner	11 ³ / ₈ " x 24 ¹ / ₈ " x 14 ¹ / ₂ "	240	3000	12.5

Four Burners

6311-2-240	Raised Four Burner	24" x 24 ¹ / ₈ " x 14 ¹ / ₂ "	240	7000	29.1
	2 Front Burners			1.5kw	
	2 Back Burners			2.0kw	



suggested uses

A popular, versatile choice for serving lines and tableside and demonstration cooking. Perfect for sautéed and pan-fried foods, such as omelets, crepes and stir-fry. Also ideal for cooking and holding soups, stews and sauces.

Single burners

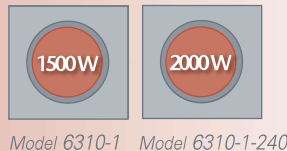

Model 6310-1 Model 6310-1-240

Double burners

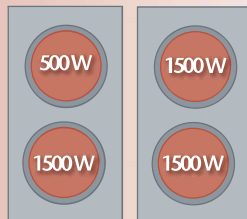

Model 6310-3 Models 6310-3-240, 6311-1-240 w/ 4" legs

Four burners

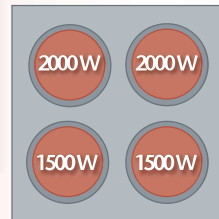

Model 6311-2-240 w/ 4" legs

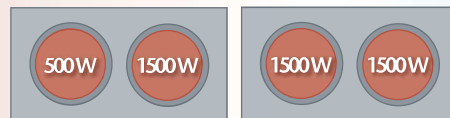

Model 6310-2 Model 6310-2-240



induction equipment

induction range

cookers & warmers



Game-Changing Efficiency. Chef-Worthy Performance.

Nemco's extraordinary induction ranges mimic the chef-level cooking performance of conventional gas ranges, but at a significantly higher energy efficiency that can put thousands of dollars to your bottom line every year.

Innovative induction technology—only from Nemco—cooks just like gas, but uses far less energy!

Induction activates a magnetic field to energize cookware in a way that literally turns the pan into its own heating element, transferring

90% of the energy directly into heating the food, while keeping the “burner” surface relatively cool to the touch. Unlike other induction brands, however, only Nemco features a “continuous field” that maintains the energizing effect, even when the pan is lifted to perform all sorts of cooking techniques.



Model 9100



Model 9110



The glass features commercial-grade impact-resistance and doesn't burn spilled foods that otherwise stain.

Drop-In Warmers **NEW!**

A look so simple, sophisticated and smooth, Nemco's drop-in induction warmer models are perfect in virtually any application, especially high-end front-of-the-house settings.

Model #	Description	Size (W x D x H)	Volts	Watts	Amps
9100	Drop-In Warmer Integrated Touch Controls	14 ⁹ / ₁₆ " x 11 ⁵ / ₈ " x 3 ¹ / ₈ "	120	350	3.0
9100-1	Drop-In Warmer Integrated Touch Controls	14 ⁹ / ₁₆ " x 11 ⁵ / ₈ " x 3 ¹ / ₈ "	208/240	400	2.0
9101	Drop-In Warmer Separate Mounted Controls	14 ⁹ / ₁₆ " x 11 ⁵ / ₈ " x 3 ¹ / ₈ "	120	350	3.0
9101-1	Drop-In Warmer Separate Mounted Controls	14 ⁹ / ₁₆ " x 11 ⁵ / ₈ " x 3 ¹ / ₈ "	208/240	400	2.0

Drop-In Ranges **NEW!**

Achieve and easily maintain a sleek, clean look on your range top with Nemco's drop-in models that sit flush with the counter surface and boast exceptional durability.

Model #	Description	Size (W x D x H)	Volts	Watts	Amps
9110	Drop-In Range Integrated Touch Controls	14 ⁹ / ₁₆ " x 11 ⁵ / ₈ " x 3 ¹ / ₈ "	120	1800	15.0
9110-C*	Drop-In Range Integrated Touch Controls	14 ⁹ / ₁₆ " x 11 ⁵ / ₈ " x 3 ¹ / ₈ "	120	1800	15.0
9110-1	Drop-In Range Integrated Touch Controls	14 ⁹ / ₁₆ " x 11 ⁵ / ₈ " x 3 ¹ / ₈ "	208/240	1800	8.6/7.5
9111-1	Drop-In Range Integrated Touch Controls	14 ⁹ / ₁₆ " x 11 ⁵ / ₈ " x 3 ¹ / ₈ "	208/240	2600	12.5/10.8
9120	Drop-In Range Separate Mounted Controls	14 ⁹ / ₁₆ " x 11 ⁵ / ₈ " x 3 ¹ / ₈ "	120	1800	15.0
9120-C*	Drop-In Range Separate Mounted Controls	14 ⁹ / ₁₆ " x 11 ⁵ / ₈ " x 3 ¹ / ₈ "	120	1800	15.0
9121-1	Drop-In Range Separate Mounted Controls	14 ⁹ / ₁₆ " x 11 ⁵ / ₈ " x 3 ¹ / ₈ "	208/240	2600	12.5/10.8
9122-1	Drop-In Range Separate Mounted Controls	14 ⁹ / ₁₆ " x 11 ⁵ / ₈ " x 3 ¹ / ₈ "	208/240	3500	16.8/14.6

*Canada.





Model 9130

Portable Ranges **NEW!**

Take the show on the road. Nemco's portable units are great for temporary cooking venues or operations with rush times that can stress kitchen space and capacity.

Model #	Description	Size (WxDxH)	Volts	Watts	Amps
9130	Portable Range	20 ¹ / ₂ " x 12" x 4 ¹ / ₂ "	120	1800	15.0
9130-C*	Portable Range	14 ⁹ / ₁₆ " x 11 ⁵ / ₈ " x 3 ¹ / ₈ "	120	1800	15.0
9131-1	Portable Range	14 ⁹ / ₁₆ " x 11 ⁵ / ₈ " x 3 ¹ / ₈ "	208/240	2600	12.5/10.8
9132-1	Portable Range	14 ⁹ / ₁₆ " x 11 ⁵ / ₈ " x 3 ¹ / ₈ "	208/240	3500	16.8/14.6

All models available with optional TempMaster™ temperature probe.

*Canada



Model 9141-1

Heavy-Duty Stockpot Ranges **NEW!**

For high-volume foods and ingredients, Nemco offers high-power induction technology in larger-size units capable of handling stockpot cookware.

Model #	Description	Size (WxDxH)	Volts	Watts	Amps
9140-1	Heavy-Duty Stockpot Range, Countertop	18" x 24" x 17"	208/240	10,000	28.0/24.0
9141-1	Heavy-Duty Stockpot Range, Floor Model	18" x 24" x 21 ⁵ / ₈ "	208/240	10,000	28.0/24.0

All models available with optional TempMaster™ temperature probe.



Even Better Than Cooking with Gas

With Nemco's proprietary TempMaster™—an optional external temperature probe—users can program portable and stockpot induction ranges to cook to, and then hold, foods at a precise temperature. That's control you can't even get with gas!





food merchandising
equipment

open-view merchandisers



Model 6421

A Window Into Higher Food Sales

For all that operators love about the hallmark functionality, durability and investment return of Nemco equipment, when it comes to retail food sales, the bottom line begins and ends with the food—not the equipment.

Understanding this—and continuously engineering to it—is what makes Nemco different.

Out of this philosophy was born the Open-View Merchandiser, in which the design was less about what we can add and more about what we can take away.

So, the question is—Will missing front corner posts, a hidden control panel, a slimmer steel frame and sharper, brighter graphics boost sales and profits?

Well, seeing is believing.



Open-View Merchandisers

Nemco's Open-View Merchandiser series is specially designed for a clean, sleek look that places every point of emphasis on the one feature that does all the selling—the sizzling product inside. Less is more with a design that includes high-quality tempered glass, "invisible" front corner posts, stylish backlit graphic headers on all three sides, and strategically placed interior lighting. The Open-View Merchandiser comes standard with chunkier brushed stainless-steel legs that make it a real class act in retail food sales.

Model #	Description	Size (WxDxH)	Volts	Watts
6420	Pizza Display Case Rotating, 3-Tier, w/12" Rack	17 ⁷ / ₈ " x 18 ¹ / ₄ " x 32 ⁵ / ₈ "	120	1550
6421	Pizza Display Case Rotating, 3-Tier, w/18" Rack	22" x 22" x 32 ⁵ / ₈ "	120	1550
6422	Pizza Display Case Rotating, 4-Tier, w/18" Rack	22" x 22" x 32 ⁵ / ₈ "	120	1550
6423	Pretzel Display Case Revolving, 2-Tier, 8-Prong Rack	22" x 22" x 32 ⁵ / ₈ "	120	1550
6424	Hot Foods Display Case, Angled, 3-Tier, 15" Sq. Shelves	17 ⁷ / ₈ " x 18 ¹ / ₄ " x 32 ⁵ / ₈ "	120	1550
6425	Hot Foods Display Case, Angled, 3-Tier, 19" Sq. Shelves	22" x 22" x 32 ⁵ / ₈ "	120	1550



suggested uses

Nemco's countertop Open-View Merchandiser is a hot sales solution for convenient stores, concession stands, kiosks, clubhouses, snack shops and other high-traffic retail operations. Great for holding and showcasing prebaked pizza and pretzels, as well as pies and other baked goods.



Every nuance of the Open-View Merchandiser is designed to maintain a clean visual appeal, including the control panel, which nests inside a recessed compartment in the back and disappears behind a closable door panel.



Model 6423



Model 6425



pizza merchandisers



Model 6451

It's All About Your Food. Period.

Sure, a lot of thinking is behind Nemco's full line of countertop food-merchandising equipment. But when staring at the drawing board, all the design team ever sees is food.

The result has been units that are never overengineered. Rather, you get simple solutions that feature the most user-friendly controls, the highest degree of visibility, the easiest to clean interiors and exteriors, and the longest-lasting performance.

No wonder so many consider Nemco "the best value in merchandising."



Pizza Merchandisers

Three- and four-tiered units are ideal for displaying multiple products at once, while holding them at controlled temperatures for better flavor and appearance. Contemporary signage and lighted interior enhance presentation. Stainless-steel, tempered-glass construction. Water reservoir keeps foods moist. Other rack styles available.

Model #	Description	Size (W x D x H)	Volts	Watts
6450	Rotating, 3-Tier Case w/12" Racks	18 ¹ / ₂ " x 18 ¹ / ₂ " x 33 ⁷ / ₈ "	120	1480
6450-4	Rotating, 4-Tier Case w/12" Racks	18 ¹ / ₂ " x 18 ¹ / ₂ " x 33 ⁷ / ₈ "	120	1480
6451	Rotating, 3-Tier Case w/18" Racks	22 ¹ / ₄ " x 22 ¹ / ₄ " x 33 ⁷ / ₈ "	120	1480
6451-2	Rotating, 3-Tier, Self-Serve Case w/18" Racks	22 ¹ / ₄ " x 22 ¹ / ₄ " x 33 ⁷ / ₈ "	120	1480
6452	Rotating, 4-Tier Case w/18" Racks	22 ¹ / ₄ " x 22 ¹ / ₄ " x 33 ⁷ / ₈ "	120	1480
6452-2	Rotating, 4-Tier, Self-Serve Case w/18" Racks	22 ¹ / ₄ " x 22 ¹ / ₄ " x 33 ⁷ / ₈ "	120	1480

Optional Accessories

Model #	Description
66785	Set of Four 4" Stainless Steel, Adjustable Legs



suggested uses

Small enough for most operations. Use for whole pizza, individual slices and boxed slices for fast, easy sales.



Pretzel Merchandisers

Two-tiered racks hold dozens of fresh, toasty pretzels that look absolutely tempting under the overhead lights (model 6453). Contemporary and stylish merchandiser signage increases traffic and impulse sales! Brushed stainless steel and tempered glass add durability and make cleaning easy.

Model #	Description	Size (W x D x H)	Volts	Watts
6403	Revolving Pretzel Warmer	15 ¹ / ₈ " x 18 ¹ / ₈ " x 27 ¹ / ₄ "	120	290
6453	Revolving Pretzel Warmer	22 ¹ / ₄ " x 22 ¹ / ₄ " x 33 ⁷ / ₈ "	120	1480

Optional Accessories

Model #	Description
66785	Set of Four 4" Stainless Steel, Adjustable Legs (for model 6453 only)



Model 6403 includes a shield over the light bulbs to protect them, while loading and unloading pretzels. The removable door easily lifts off for cleaning.

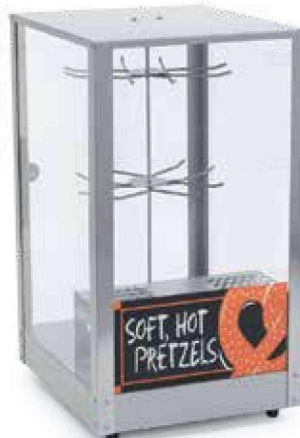

suggested uses

Compact enough for theaters, convenience stores, concession stands and other high-traffic retail centers. Also great for bagels!



Model 6453 offers thermostatic control up to 200°F and incorporates a water reservoir to maintain humidity.



humidified merchandiser



New Meaning to a 'Soft Sell'

The simply undeniable truth of retail baked goods is that when the food goes dry, so do the sales. And, well, so does your brand.

That's why, for consistent, lasting 'soft-sell' performance, Nemco engineering went hard core with its latest humidified merchandiser.

The result is a unit that is as rugged-tough as it is artfully designed, promising your customers the moist, fresh, baked-good satisfaction they want, while delivering to you the equipment lifetime ROI you demand.

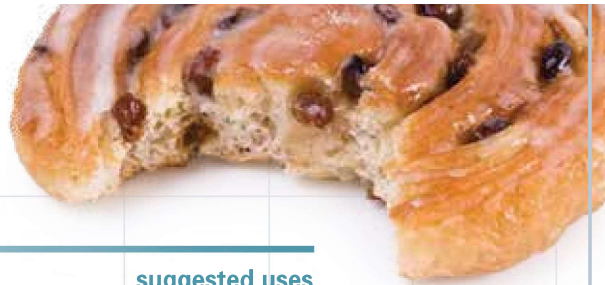

Humidified Merchandiser **NEW!**

Never let a muffin lose its moisture again! Keep your baked foods tasting good and looking good in this humidified merchandiser. An onboard water reservoir prevents your product from drying out, while two-way mirrors on both sides and the rear door make for maximum eye-catching appeal. Self-closing, slow-return doors ensure a complete closure to hold temperature and moisture, and avoid energy waste. Made of powder-coated stainless steel for durability. Comes with electronic controls for easy adjustments in temperature and humidity.

Model #	Description	Size (WxDxH)	Volts	Watts
6470	Heated Case	29 ¹³ / ₁₆ " x 28 ⁷ / ₄ " x 30 ⁵ / ₈ "	120	1750



suggested uses

This compact unit is perfect for c-stores, snack shops and a host of other retail applications. Keeps fresh a wide range of baked items, including croissants, muffins, bagels, cookies and more.

Grab'n Go Merchandiser

"Compact" doesn't begin to describe the Grab'n Go. This one-of-a-kind merchandiser is specially designed with a narrow, vertical frame that, just like a book on a bookshelf, slides right into place on even the most congested checkout counters. Clear paneling, interior lighting and heated, angled shelves with interchangeable magnetic graphics showcase the food beautifully. Polycarbonate materials, stainless-steel construction and a powder-coat finish add durability.

Model #	Description	Size (WxDxH)	Volts	Watts
6655	Heated Case	10 ¹ / ₈ " x 16 ³ / ₄ " x 24 ³ / ₈ "	120	345



suggested uses

Heated shelves make this a versatile little showcase unit, perfect for sandwiches, cookies, donuts, warm baked goods and all sorts of other "on the go" favorites.



Countertop Humidified Merchandiser

Never let your profit potential dry up. Nemco's humidified merchandiser combines a high-visibility showcase solution—complete with clear, tempered-glass panels, interior lighting, angled shelves and graphics—with a water reservoir that keeps baked goods and other warm foods moist and fresh for extended periods of time. Stainless-steel construction with powder-coating adds durability, while manual temperature and humidity controls add versatility.

Model #	Description	Size (WxDxH)	Volts	Watts
6475	Heated Case	20" x 17" x 26"	120	826



suggested uses

This compact unit is perfect for c-stores, snack shops and a host of other retail applications. Keeps fresh a wide range of baked items, including croissants, muffins, bagels, cookies and more.



shelf merchandisers



Model 6480-36S

Just When the Market Was Ready to Give Up . . .

When it came to merchandising hot foods, two axioms were clear.

One: Many foodservice operators would like to display and hold their sale items at optimum temperature for longer than 30 minutes.

Two: Those same operators had resigned themselves to the fact that it couldn't be done.

After all, given the challenge, some of the leading names in food-warming equipment just couldn't pull off the design solution.

Then along came Nemco, developing a genuinely new achievement in extended food warming, while also providing a clean and simply attractive design, worthy of every kind of application from c-stores to high-end caterers.



Shelf Merchandisers

Finally! A food-merchandising solution that can really showcase hot foods by holding them at optimum temperatures for hours. Each shelf has its own top and bottom heating with independent thermostats to accommodate variable temperature settings. Features also include a lighted merchandising area, glass sides, adjustable divider rods for easy organization of food product, and an overall stainless-steel construction as part of Nemco's trademark commercial-grade durability design. Powder coating and custom graphic signage available.

suggested uses

Extremely versatile, the holding capability is perfect for virtually any hot-selling foods you need to merchandise for extended periods of time, while the design fits perfectly in all sorts of high-volume venues, from commissaries and c-stores, to chains and even upscale caterers.

Model #	Description	Size (WxDxH)	Volts	Watts	Amps
Horizontal, Dual Shelves					
6480-18	18" Stainless	18" x 19 ³ / ₄ " x 21 ⁷ / ₈ "	120	860	7.2
6480-18-B	18" Black	18" x 19 ³ / ₄ " x 21 ⁷ / ₈ "	120	860	7.2
6480-24	24" Stainless	24" x 19 ³ / ₄ " x 24"	120	1160	9.7
6480-24-B	24" Black	24" x 19 ³ / ₄ " x 24"	120	1160	9.7
6480-30	30" Stainless	30" x 19 ³ / ₄ " x 24"	120	1460	12.2
6480-30-B	30" Black	30" x 19 ³ / ₄ " x 24"	120	1460	12.2
6480-36	36" Stainless	36" x 19 ³ / ₄ " x 24"	120	1800	15.0
6480-36-B	36" Black	36" x 19 ³ / ₄ " x 24"	120	1800	15.0

Slanted, Dual Shelves

6480-18S	18" Stainless	18" x 19 ³ / ₄ " x 25 ³ / ₈ "	120	860	7.2
6480-18S-B	18" Black	18" x 19 ³ / ₄ " x 25 ³ / ₈ "	120	860	7.2
6480-24S	24" Stainless	24" x 19 ³ / ₄ " x 27 ¹ / ₂ "	120	1160	9.7
6480-24S-B	24" Black	24" x 19 ³ / ₄ " x 27 ¹ / ₂ "	120	1160	9.7
6480-30S	30" Stainless	30" x 19 ³ / ₄ " x 27 ¹ / ₂ "	120	1460	12.2
6480-30S-B	30" Black	30" x 19 ³ / ₄ " x 27 ¹ / ₂ "	120	1460	12.2
6480-36S	36" Stainless	36" x 19 ³ / ₄ " x 27 ¹ / ₂ "	120	1800	15.0
6480-36S-B	36" Black	36" x 19 ³ / ₄ " x 27 ¹ / ₂ "	120	1800	15.0

Looking for other sizes, configurations or colors? Call Nemco for details.

Optional Accessories

Sign Kits—includes header, header bracket, menu cards and menu holder for each shelf.

Model #	Description
68773-18	Dual Shelf Merchandiser Sign Kit— 18"
68773-24	Dual Shelf Merchandiser Sign Kit— 24"
68773-30	Dual Shelf Merchandiser Sign Kit— 30"
68773-36	Dual Shelf Merchandiser Sign Kit— 36"



Model 6480-18S-B

Heated Snack Merchandiser

Incredibly space-efficient, the Heated Snack Merchandiser has a compact footprint that will fit virtually anywhere on your counter. Features a stainless-steel frame and tempered glass, an impact-resistant polycarbonate door, and heating elements made of Incoloy® nickel-based metal for high-temperature corrosion resistance. Temperature control heats up to 190°F.

suggested uses

Ideal for all kinds of sandwiches, donuts, baked goods, concession-type snack items and other warm, fresh-made foods.

Model #	Description	Size (WxDxH)	Volts	Watts
6457	Heated Case w/Two Movable Square Shelves, 13"x 10 ¹ / ₄ "	14" x 14" x 22"	120	390



suggested uses

Tasty popcorn adds excitement wherever people shop. Perfect for video stores, convenience stores, groceries and concession stands.

Contemporary and stylish merchandiser signage increases traffic and impulse sales!



Model 6440

Popcorn Poppers

The innovative heated deck keeps popcorn irresistibly warm and crisp. The stainless-steel kettle features an underside aluminum dissipater plate that distributes heat for even popping. Plus, the kettle removes in a snap for easy cleaning of both the kettle and the cabinet interior.

Model#	Description	Size (WxDxH)	Volts	Watts	Amps
6440	8 oz. Popper	19½" x 14½" x 30½"	120	1190	9.9



suggested uses

The versatility of Nemco's heat shelf makes it useful for all sorts of applications, including kitchen wait stations, pass-through areas, serving lines, buffets and more. It can find a place in the back or front of the house, and is especially useful where overhead radiant warmers are not available or not quite enough to achieve those slightly higher temperatures or longer hold times. Use the heat shelf to hold plated foods or boxed to-go orders. Or hold a serving pan on its stainless-steel surface and maximize the power of conduction heat.

Heat Shelves

Operators now have a smart, extremely versatile solution for keeping ready-to-serve foods at their warm, appetizing best. Nemco's electric heat shelf is perfect for the kitchen, the pass-through station or, with its special design features, the front of the house too. The unique heating elements minimize temperature drops across the surface, resulting in reliable, uniform holding and the capability to heat up to 220°F. Includes all stainless-steel construction, an ergonomic control dial and rounded corners for a contemporary look. Plus, it's available with black powder-coated sides—standard!

Model #	Description	Size (WxDxH)	Volts	Watts	Amps
6301-18	18" Black	18" x 20" x 3"	120	250	2.1
6301-18-SS	18" Stainless	18" x 20" x 3"	120	250	2.1
6301-24	24" Black	24" x 20" x 3"	120	350	2.9
6301-24-SS	24" Stainless	24" x 20" x 3"	120	350	2.9
6301-30	30" Black	30" x 20" x 3"	120	425	3.5
6301-30-SS	30" Stainless	30" x 20" x 3"	120	425	3.5
6301-36	36" Black	36" x 20" x 3"	120	500	4.2
6301-36-SS	36" Stainless	36" x 20" x 3"	120	500	4.2
6301-48	48" Black	48" x 20" x 7"	120	700	5.8
6301-48-SS	48" Stainless	48" x 20" x 7"	120	700	5.8
6301-60	60" Black	60" x 20" x 7"	120	850	7.1
6301-60-SS	60" Stainless	60" x 20" x 7"	120	850	7.1
6301-72	72" Black	72" x 20" x 7"	120	1,000	8.3
6301-72-SS	72" Stainless	72" x 20" x 7"	120	1,000	8.3



Model 6301-24

* Note: 18" through 36" models will be supplied with ½" feet; 48" through 72" models will be supplied with 4" legs to meet NSF Standard 4.



suggested uses

Perfect for video and convenience stores, groceries, delis and cafeteria-style lines where presentation provides added value.



Model 6454



Model 6460

Heated Display Cases

Stainless-steel construction and sliding tempered-glass doors provide a neat appearance and long life. Three removable shelves enhance presentation. Pullout crumb tray makes cleanup a snap. Thermostat control up to 200°F. Available options: two 40-watt bulbs for product illumination and a water reservoir for humidity control.

Model #	Description	Size (W x D x H)	Volts	Watts
6460	Heated Display Case w/Light, Water Reservoir, 3 Removable Shelves	28 ¹ / ₄ " x 13 ¹ / ₈ " x 24"	120	780
6461	Heated Display Case w/ 3 Removable Shelves	28 ¹ / ₄ " x 13 ¹ / ₈ " x 24"	120	700
6454	Heated Case w/3 15" Square Angled Shelves	18 ¹ / ₂ " x 18 ¹ / ₂ " x 33 ⁷ / ₈ "	120	1480
6454-2	Heated Self-Serve Case w/3 15" Square Angled Shelves	18 ¹ / ₂ " x 18 ¹ / ₂ " x 33 ⁷ / ₈ "	120	1480
6455	Heated Case w/3 19" Square Angled Shelves	22 ¹ / ₄ " x 22 ¹ / ₄ " x 33 ⁷ / ₈ "	120	1480
6455-2	Heated Self-Serve Case w/3 19" Square Angled Shelves	22 ¹ / ₄ " x 22 ¹ / ₄ " x 33 ⁷ / ₈ "	120	1480

Optional Accessories

Model #	Description
66785	Set of Four 4" Stainless Steel, Adjustable Legs



suggested uses

Perfect for holding any hot foods that don't require humidity assist. Ideal for convenience stores, carry-out pizza kitchens and other similar operations. The cavity width accommodates most any foodservice dish or container, which makes it great for cafeterias, catering lines and virtually any high-volume, hot-food operation.



Model 6410

Hot Holding Cabinets

Whether you're trying to stay ahead of high-volume rush times or extend the oven-fresh quality of your hot takeout orders, Nemco's Hot Holding Cabinets offer the perfect solution. Each unit comes factory preset to the perfect holding range between 145° and 187° F, with no manual controls for staff to mess with. The width of the body and the easy interchangeability of the racks accommodate anything from 18" boxed pizza to half sheet pans and a range of other wide items. The door features scratch-resistant tempered glass and a self-drawing, self-sealing closure. Also features stainless-steel construction throughout and a self-monitoring function that alerts staff if the holding temperature has been compromised.

Model#	Description	Size (W x D x H)	Volts	Watts	Amps
6405	Countertop Cabinet	22 ¹ / ₈ " x 24 ⁷ / ₈ " x 22 ⁷ / ₈ "	120	1230	10.3
6410	Floor Cabinet	22 ¹ / ₈ " x 24 ⁷ / ₈ " x 33 ⁷ / ₈ "	120	1230	10.3



merchandisers

soup stations



Model 6510A-2D4



Model 6510A-2D7P

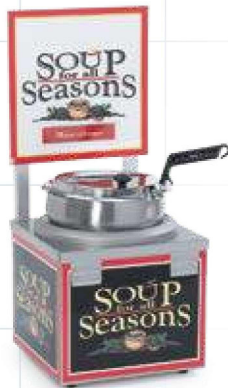

Model 6510A-S7



Model 6510-T4

Soup Merchandisers

Turn your customers on to the idea of a hearty bowl of soup with these inviting soup-warmer merchandisers, each adorned with a classic-looking "Soup for all Seasons" graphic. A unique heating-element design maintains an even holding temperature and prevents hot spots. Twin warmers have separate thermostats for better temperature control. Plus, the header comes with interchangeable tab cards bearing the names of nearly 50 popular soups.

Model #	Description	Size (W x D x H)	Volts	Watts
6510A-2D4	4 Quart, Twin Well Double Thermostat w/Header	20 ¹ / ₂ " x 10 ¹ / ₂ " x 20 ¹ / ₂ "	120	1000
6510A-2D4P	4 Quart, Twin Well Double Thermostat, No Header	18 ⁵ / ₈ " x 10 ³ / ₈ " x 9 ⁷ / ₈ "	120	1000
6510A-2D7	7 Quart, Twin Well Double Thermostat w/Header	24 ¹ / ₂ " x 13 ³ / ₈ " x 21 ⁵ / ₈ "	120	1100
6510A-2D7P	7 Quart, Twin Well Double Thermostat, No Header	24 ¹ / ₂ " x 12" x 11 ³ / ₄ "	120	1100
6510A-S7	7 Quart, Single Well Single Thermostat w/Header	13" x 12 ³ / ₈ " x 21 ⁵ / ₈ "	120	550
6510A-S7P	7 Quart, Single Well Single Thermostat, No Header	11 ⁷ / ₈ " x 12 ³ / ₈ " x 11 ⁵ / ₈ "	120	550
6510-T4	4 Quart, Triple Well Single Thermostat w/Header and Adaptor Plate	25 ¹ / ₈ " x 16" x 20 ¹ / ₄ "	120	1500
6510-T4P	4 Quart, Triple Well Single Thermostat, No Header, w/Adaptor Plate	25 ¹ / ₈ " x 14 ⁵ / ₈ " x 11"	120	1500
6510-D7	7 Quart, Twin Well Single Thermostat w/Header and Adapter Plate	25 ¹ / ₈ " x 16" x 20 ¹ / ₄ "	120	1500
6510-D7P	7 Quart, Twin Well Single Thermostat, No Header, w/Adapter Plates	25 ¹ / ₈ " x 14 ⁵ / ₈ " x 11"	120	1500

Optional Accessories

Model #	Description	Fits Models
68393-4	4 Quart Inset, Hinged Cover and Ladle	6510A-2D4, 6510A-2D4P, 6510-T4, 6510-T4P
68393-7	7 Quart Inset, Hinged Cover and Ladle	6510A-2D7, 6510A-2D7P, 6510A-S7, 6510A-S7P, 6510-D7, 6510-D7P

Custom graphics are available. Call the Nemco factory for information.

All Nemco cooker & warmers are listed NSF/ANSI Standard 4, making them certified "rethermalization equipment."



cold food holding

cold condiment station



Hold The Mayo

No, really. Hold the mayo, the coleslaw, the potato salad or virtually any chilled customer favorite in a self-serve or other open-display application with Nemco's latest countertop equipment innovation!

Display for your customers the widest variety of condiments and other chilled foods with the one

countertop solution that gives you unprecedented versatility and temperature control!

Nemco's Cold Condiment Station has all the features you need to consistently hold chilled, even potentially hazardous, foods at safe temperatures.



suggested uses

Nemco's Cold Condiment Station is a must-have accessory on any C-store self-serve island for its NSF-approved ability to keep all your "refrigerate-after-opening" items fresh. It's also ideal for buffet lines, salad bars and other applications where potato, pasta and bean salads, puddings and other refrigerated foods and desserts remain out on display.



Digital thermostat control and display (with C° and F°) easily enable employees to monitor and adjust the temperature—located in the back of the unit to keep control out of customer sight to avoid tampering

Cold Condiment Station

Display your self-serve, chilled customer favorites with Nemco's latest compact countertop-equipment innovation. Our Cold Condiment Station has all the features you need to consistently hold chilled, even potentially hazardous, foods at safe temperatures. Featuring an electronic thermostat control with a digital display and an integrated 1/8 horsepower refrigeration-condensing unit, Nemco's Cold Condiment Station has the capacity to maintain food-safe temperatures (32°–41°F) or colder, regardless of ambient temperature. Durable stainless-steel exterior with multiple-pan configurations for food-choice flexibility.

Model #	Description	Size (W x D x H)	Volts	Watts	Amps	Hz
9010	Station w/4-1/8 Plastic Pans w/Clear Hinged Lids	17 7/8" x 28" x 11 3/4"	120	255	2.1	60



suggested uses

Nemco's Cold Condiment Chiller is a must-have accessory on any convenience store self-serve island or stadium concessions counter. It keeps fresh all kinds of fruit garnishes for smoothies, as well as "refrigerate-after-opening" items, such as relish, onions, pickles, salsa, jalapeños, sauerkraut, banana peppers and more.



Model 9020-3

Cold Condiment Chiller

Expand your self-serve offering of condiments and other chilled foods with the industry's most compact NSF unit. The Cold Condiment Chiller features thermoelectric technology that effectively holds at required temperatures without the noise, maintenance and space-hogging drawbacks of conventional compressor units. A simple sleek look and feel makes it appealing in a high visibility self-serve application.

Model #	Description	Size (W x D x H)	Rating	Hz
9020	Chiller Only (no pans included)	15" x 9 1/4" x 11 3/4"	6.7A @ 12Vdc	60
9020-1	1-1/8 Stainless Steel Pan w/Clear Hinged Lid	15" x 9 1/4" x 11 3/4"	6.7A @ 12Vdc	60
9020-2	2-1/8 Stainless Steel Pans w/Clear Hinged Lids	15" x 9 1/4" x 11 3/4"	6.7A @ 12Vdc	60
9020-3	3-1/8 Stainless Steel Pans w/Clear Lids	15" x 9 1/4" x 11 3/4"	6.7A @ 12Vdc	60

NOTE: This product is not intended for use with foods that require a specific temperature to ensure food safety.





Condiment Bars

Give 'em the works without making more work for yourself. Cap off your hot-dog serving area with one of these neat, efficient, no-waste condiment bars. Stainless-steel construction effectively retains the temperature of the ice pack. Pumps provide dispensing with minimal effort.

Model #	Description	Size (W x D x H)	No. of Pans	Capacity/Type
88100-CB-1	Condiment Bar w/2- 3 Qt. Stainless Steel Pans w/Pumps	25 ³ / ₄ " x 8" x 12"	1	6.1 qts. Each/Stainless Steel
88100-CB-2	Condiment Bar w/2- 3 Qt. Stainless Steel Pans w/Pumps	25 ³ / ₄ " x 8" x 12"	3	1.1 qts. Each/Stainless Steel
88100-CB-3	Condiment Bar w/2- 3 Qt. Stainless Steel Pans w/Pumps	25 ³ / ₄ " x 8" x 12"	3	0.6 qts. Each/Stainless Steel
88101-CB-1	Condiment Bar w/2- 1.5 Qt. Plastic Pans w/Pumps	24" x 7 ¹ / ₂ " x 9 ¹ / ₂ "	3	1.1 qts. Each/Plastic
88101-CB-2	Condiment Bar w/2- 1.5 Qt. Plastic Pans w/Pumps	24" x 7 ¹ / ₂ " x 9 ¹ / ₂ "	3	0.6 qts. Each/Plastic
88101-CB-2P*	Condiment Bar w/2- 1.5 Qt. Plastic Pans w/Pumps	24" x 7 ¹ / ₂ " x 9 ¹ / ₂ "	3	0.6 qts. Each/Plastic
88250-CB	Ice Pack, One Each			

*Includes two ice packs



Model 88100-CB-2





suggested uses

Works in tough back-of-the-house applications, but has the finesse to hold its appeal in self-serve lines too. Great for toasting bread, bagels, English muffins, premade waffles and other items commonly dropped in a toaster at home.



Model 6805



Model 6800

Conveyor Toasters

Nothing promises better toasting perfection, with less maintenance hassle, than the Nemco Conveyor Toaster—featuring a smart, simple design that delivers outstanding performance, with no wasted energy. Nemco’s proprietary element pattern provides consistent toasting, left to right, across the entire conveyor, while the four-position rotary switch—with optional one- or two-side toasting—includes a ‘stand-by’ mode that conserves energy by running the topside element at a low temperature when the unit sits idle. A black powder-coat top and stainless-steel body, with heat-releasing louvers that keep it cool to the touch, make it a great model for front-of-the-house operations with self-serve lines. For 300-piece/hour capacity, choose model 6800. Or, for a higher volume, such as 1,000 pieces/hour, go with model 6805.

Model #	Description	Size (W x D x H)	Volts	Watts
6800	2-Slice Toaster	14" x 18" x 15"	120	1660
6800-PP	2-Slice Toaster w/Prison Package	14" x 18" x 15"	120	1660
6805	3-Slice Toaster	19" x 18" x 15"	220	3600



waffle & cone
bakers

waffle bakers



Model 7000A-2 & 7000A-S

Waffle Bakers

Nemco Waffle Bakers are so easy to use, they're perfect for self-serve buffet lines. Simply fill and close the grid, then push the timer. Top-mounted digital controls maintain ideal baking temperature. Sensors ensure uniform baking on both sides. LED readout counts down baking time (typically only 3½ minutes!), and the bell signals when done. Floating hinges allow top grid to rise as waffle bakes to perfection. Interlocking grids reduce batter overflow. Coiled, spring-type handles never get hot. Bake up to 20 seven-inch-diameter waffles per hour, per grid. Easy-to-clean SilverStone® grids available.

Model #	Description	Size (WxDxH)	Volts	Watts	Amps
7000A	Single	10" x 18 ³ / ₈ " x 8 ¹ / ₈ "	120	890	7.4
7000A-S	Single w/SS*	10" x 18 ³ / ₈ " x 8 ¹ / ₈ "	120	890	7.4
7000A-240	Single	10" x 18 ³ / ₈ " x 8 ¹ / ₈ "	240	890	3.7
7000A-S240	Single w/SS*	10" x 18 ³ / ₈ " x 8 ¹ / ₈ "	240	890	3.7
7000A-2	Dual	19½" x 18 ³ / ₈ " x 8 ¹ / ₈ "	120	1780	14.8
7000A-2S	Dual w/SS*	19½" x 18 ³ / ₈ " x 8 ¹ / ₈ "	120	1780	14.8
7000A-2240	Dual	19½" x 18 ³ / ₈ " x 8 ¹ / ₈ "	240	1780	7.4
7000A-2S240	Dual w/SS*	19½" x 18 ³ / ₈ " x 8 ¹ / ₈ "	240	1780	7.4

Height with handle up 17¹/₈"

*SS = SilverStone



suggested uses

Designed to fit flush against the wall, Nemco Waffle Bakers are great for front-of-the-house setups. Popular for breakfast, brunch, lunch and all times in between, waffles are ideal for creating new signature items. Top with fruit, dairy specialties, dessert sauces and more.



Model 7020A

Belgian Waffle Bakers

Choose a model with a removable grid for super-easy cleaning or stay with the more economical fixed grid.

Model #	Description	Size (W x D x H)	Volts	Watts	Amps
7020A	Removable	10" x 18 ³ / ₄ " x 10 ⁵ / ₈ "	120	980	8.2
7020A-1	Fixed	10" x 18 ³ / ₄ " x 10 ⁵ / ₈ "	120	980	8.2
7020A-S	Removable w/SS*	10" x 18 ³ / ₄ " x 10 ⁵ / ₈ "	120	980	8.2
7020A-1S	Fixed w/SS*	10" x 18 ³ / ₄ " x 10 ⁵ / ₈ "	120	980	8.2
7020A-1AS	Auto-Start, Fixed w/SS	11 ¹ / ₂ " x 19 ¹ / ₂ " x 10 ³ / ₄ "	120	890	7.5
7020A-208	Removable	10" x 18 ³ / ₄ " x 10 ⁵ / ₈ "	208	980	4.7
7020A-S208	Removable w/SS*	10" x 18 ³ / ₄ " x 10 ⁵ / ₈ "	208	980	4.7
7020A-1208	Fixed	10" x 18 ³ / ₄ " x 10 ⁵ / ₈ "	208	980	4.7
7020A-1S208	Fixed w/SS*	10" x 18 ³ / ₄ " x 10 ⁵ / ₈ "	208	980	4.7
7020A-240	Removable	10" x 18 ³ / ₄ " x 10 ⁵ / ₈ "	240	980	4.1
7020A-S240	Removable w/SS*	10" x 18 ³ / ₄ " x 10 ⁵ / ₈ "	240	980	4.1

Height with handle up 21"

*SS = SilverStone

Optional Accessories

Model #	Description
77241	Drip Tray, Stainless Steel
77391	Drip Tray, Polycarbonate

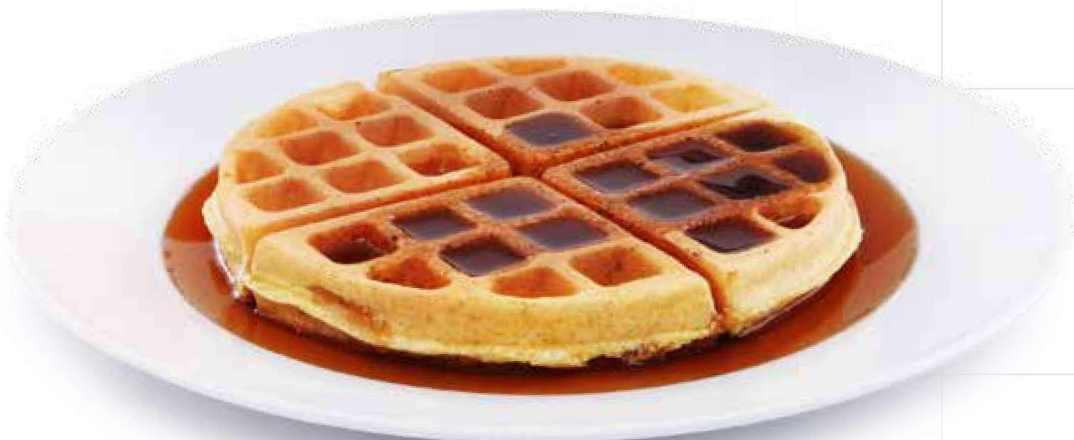

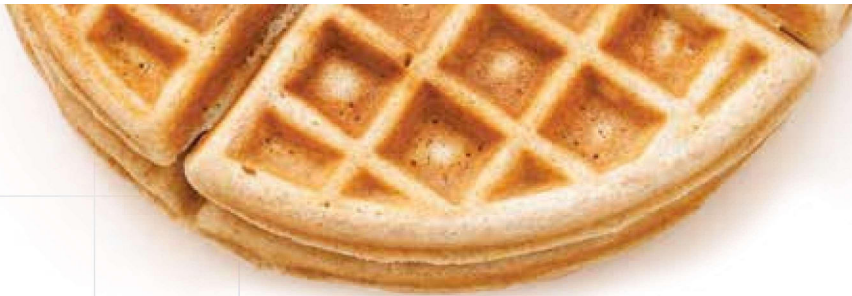

**Self-Serve
Made Super-Easy!**

Less labor for you means more money for you. Pair up the NEW Batter Dispenser with the NEW auto-start Belgian Waffle Baker (model 7020A-1AS on p. 76) and let your customers enjoy preparing their own fresh-baked waffles!



Batter Dispenser

Take your breakfast buffet line to another level with Nemco's super easy-to-use batter dispenser that simplifies self-serve waffle making. A soda-machine-style valve dispenser features a smooth flow for convenience and a reliable seal to minimize mess. The stainless-steel construction adds durability, while the faceplate graphics apply an attractive visual accent.

Model #	Description	Size (WxDxH)
7050	Batter Dispenser	12" x 12" x 18 1/4"

Cone Bakers

For fast, convenient, precision baking of waffle cones. Preheats in just 12 minutes and produces up to 60 cones per hour, per grid. Heavy-duty, lockdown, fixed, seven-inch aluminum grids provide uniform thickness, while flat-ring heating elements bake to a taste-tempting, overall golden brown. Easy-to-read LED display counts down baking time. Audible alarm signals the minute baking is complete. Coiled, spring-type handle remains cool for fast, easy handling.



Model 7030A-2 and 7030A

Model #	Description	Size (WxDxH)	Volts	Watts	Amps
7030A	Single	10" x 19 3/4" x 8 1/8"	120	890	7.4
7030A-240	Single	10" x 19 3/4" x 8 1/8"	240	890	3.7
7030A-2	Dual	19 1/2" x 19 3/4" x 8 1/8"	120	1780	14.8
7030A-2240	Dual	19 1/2" x 19 3/4" x 8 1/8"	240	1780	7.4

Height with handle up 17 1/2"

Optional Accessories

Model #	Description
77005	Cone Form Roller. Makes 7" Finished Cones
77006	Walking Sundae Mold



countertop ovens
& boiling unit

countertop boiling unit



Model 6760-240

Easier Than Boiling an Egg?

Operators would like that. So, Nemco stepped up.

First, Nemco's countertop boiler innovation gave even the smallest kitchens the ability to expand their menus in a big way.

Now, with more innovative improvements, including programmable digital cooking controls—incidentally, relocated for safer accessibility without having to reach over the heat—Nemco has given those same kitchens a better way to expand, no matter how inexperienced the staff might be.



suggested uses

Use for all types of pasta, vegetables, dumplings, shellfish and more. Also great for reconstituting food and reheating frozen items.

Countertop Boiling Unit **NEW!**

Built for speed and built to last, this boiler preheats in 12 minutes and recovers extremely quickly. Stainless-steel construction with a powder-coat top and durable-alloy twin baskets with insulated grips enhance performance life. Smaller accessory baskets give you the quick-serve ability to cook and drain up to six individual orders at once. A digital thermostat—with a temperature range of 100° F to 212° F—and programmable timing provide versatile cooking control. A turn-knob drain mechanism makes cleaning easy..

Model #	Description	Size (WxDxH)	Volts	Watts	Amps
6760-240	Single Tank, 2 Twin Baskets. 2.5 Gallon Capacity	12" x 24" x 16"	240	6000	25.0

Optional Accessories

Model #	Description
66785	Set of 4 Stainless Steel, Adjustable Legs
69582	Set of Six 4" x 4" x 4" Baskets



Optional Baskets

Accessory basket set lets you cook and drain 6 individual servings separately.



suggested uses

Nemco countertop baking and pizza ovens are great for rethermalizing and baking foods in snack bars, taverns and concession stands.



Model 6205

Countertop Pizza Ovens

Get the incredible bake of an authentic deck-oven pizza in this unique countertop model. Each is equipped with a genuine baking stone for that killer pizza taste. Model 6205-240 bakes fast and recovers quickly. Two removable 19-inch stone decks and heavy-duty metal-sheath elements distribute heat evenly. The reflective stainless-steel surface ensures even baking under the top deck. Temperature range of 300°–700°F. Six-foot cord comes from the right bottom rear.

(Must use a pan or screen with frozen foods.)

Model #	Description	Size (WxDxH)	Volts	Watts	Amps
6205	Square Deck	25 1/4" x 26" x 22"	120	1800	15.0
6205-240	Square Deck	25 1/4" x 26" x 22"	240	5400	22.5

Optional Accessories

Model #	Description
55855	Oven Paddle
66785	Set of 4 Stainless Steel, Adjustable Legs
66795	Baking Stone



Optional Paddle

Keep up when the heat is on with this durable, aluminum-construction sandwich/pizza paddle that's the perfect companion for your busy countertop oven.



countertop ovens

suggested uses

Nemco's ovens are ideal for reheating foods in snack bars, taverns, concession stands and other retail operations. They're perfect for reheating pizza, cookies, pastries, rolls, fresh breads, pies, toasted sandwiches and all sorts of other precooked items.



Model 6200



Model 6215

Countertop Warming & Baking Oven

Now you can have a fully functional, multipurpose oven, right on your countertop to bring more, big-menu variety to even the smallest kitchen. Just plug into a standard outlet, and add more baking capacity to your operation instantly. Takes minimal counterspace with no ventilation required. Thermostatic control to 700°F with independent on-off switches for upper and lower heating elements. Sixty-minute timer. Comes with two 15¹/₈" by 14¹/₄" wire shelves; holds up to four.

Model #	Description	Size (WxDxH)	Volts	Watts	Amps
6200	Warming and Baking Oven	19 ¹ / ₂ " x 22" x 23 ³ / ₄ "	120	1500	12.5



Countertop Ovens

Smaller, lower-volume foodservice operations, such as kiosks, bowling alleys and taverns, can bake virtually anything in this compact, low-profile single-rack countertop oven. Choose from two stainless-steel models with 13¹/₂" by 13³/₈" wire racks (fits 12" pizza), 15-minute timer, and upper and lower heating elements. Model 6210 features independent on-off switches for upper and lower heating elements, thermostatic control to 700°F and a 60-minute bell timer. Model 6215 features a 450°F preset thermostat and 15-minute timer switch. Both have a crumb tray for easy cleaning.

Model #	Description	Size (WxDxH)	Volts	Watts	Amps
6210	All-Purpose Oven	21 ¹ / ₄ " x 21 ¹ / ₂ " x 8 ⁷ / ₈ "	120	1500	12.5
6215	Pizza Oven	19 ¹ / ₈ " x 20 ¹ / ₂ " x 7 ⁷ / ₈ "	120	1450	12.1





kitchen essentials

kitchen essentials

suggested uses

Great for crazy-busy, high-volume kitchens of all kinds—especially fast-food, fast-casual, cafeteria and other highly process-oriented operations. Serves as a never-fail reminder for a wide range of continuous kitchen chores, even outside of cooking.



TaskMaster™ Timer

When time is of the essence, master it all with this programmable genius. Nemco's TaskMaster multichannel timer can store the timing protocols of up to 64 kitchen activities, with the ability—depending on the given model—to run as many as eight or 16 of these protocols simultaneously. The TaskMaster, literally, is as easy as pushing a button and comes preprogrammed from the factory with basic settings—or to your specs. It also features a volume-adjustable alert and a large-font LCD display that clearly tells the staff what action to take when the alert sounds.

Model #	Description	Size (W x D x H)	Volts
2550-8	8-Channel, Single-Display	8 ¹ / ₈ " x 2" x 4 ³ / ₄ "	105-265
2550-16	16-Channel, Twin-Display	14" x 2" x 5"	105-265



suggested uses:

The RinseWell is compact and functionally versatile enough to work in virtually any restaurant, bar, coffee shop or ice cream operation—from your conventional stationary stand or parlor shop to food trucks and mobile carts.



RinseWell® Smart Eco Rinse **NEW!**

Worry about your customers, not your utility bills! While other dipper well systems use heat or constantly running water to sanitize utensils, the RinseWell Smart Eco Rinse is the first and only dipper well controller that utilizes aqueous ozone. The patent-pending RinseWell controller uses advanced optics to know when to kick into gear. The RinseWell idly recirculates water until it detects cloudiness (dirty utensils!)—then it deploys fresh water to clear the murky water while injecting its chemical-free aqueous ozone to sanitize your utensils—all with cool water. No more scalded employees. No harmful bacteria on your equipment. And no more scoops so hot they melt ice cream on contact. Saving water and energy expenses without sacrificing speed of service. The RinseWell Smart Eco Rinse can pay for itself in months!

Model #	Description	Size (WxDxH) RinseWell	Size (WxDxH) Spade Well	Volts	Amps
3000-7	Smart Eco-Rinse, w/7" Spade Well	9" x 12" x 3"	7" x 6 ¹ / ₄ " x 5 ⁷ / ₈ "	120	1.5
3000-10	Smart Eco-Rinse, w/10" Spade Well	9" x 12" x 3"	10" x 6 ¹ / ₂ " x 5 ⁷ / ₈ "	120	1.5
3000-13	Smart Eco-Rinse, w/13" Spade Well	9" x 12" x 3"	12 ³ / ₄ " x 6 ³ / ₄ " x 5 ⁷ / ₈ "	120	1.5
3000-19	Smart Eco-Rinse, w/19" Spade Well	9" x 12" x 3"	20 ⁵ / ₈ " x 6 ¹ / ₈ " x 7 ⁷ / ₈ "	120	1.5
3005-606	Smart Eco-Rinse, w/6" Round Dip Well	9" x 12" x 3"	6" Deep	120	1.5





suggested uses

Great for ice cream shops, kiosks, delis or concession stands—especially those that see heavy traffic. Also great for food-court operations that use scoops to serve potato, macaroni and other cold salads and slaws.



Model 77316-7 and 77316-19

Spade Well

Features a continuous flow of water to maintain optimum cleanliness of your ice cream spades and scoops for better food quality. No more flavor transfer and no more cross-contamination that increases your food-safety risks. Wells are available in a variety of sizes—each one designed with wide compartments that allow for easy access to and removal of the spades during rush times. Versatile mounting capabilities and optional left- or right-side spigot orientation adapt to your kitchen. Units are easy to turn off, drain and disassemble for cleaning, and they all meet NSF approval.

Model #	Description	Size (W x D x H)
77316-7A	Spade Well	7" x 6 ¹ / ₄ " x 5 ⁷ / ₈ "
77316-10A	Spade Well	10 ³ / ₈ " x 6 ¹ / ₂ " x 5 ⁷ / ₈ "
77316-13A	Spade Well	12 ³ / ₄ " x 6 ³ / ₄ " x 5 ⁷ / ₈ "
77316-19	Spade Well	20 ⁵ / ₈ " x 6 ¹ / ₈ " x 7 ¹ / ₈ "

77350	Spade Well, 10" Divider
77353	Spade Well, 13" Divider
77324	Spade Well, 19" Divider
77358*	Spade Well, Installation Kit

*Not included with Spade Well.



Butter Spreader

This is the easiest and most efficient way to spread butter! Roller design promotes even, consistent application on all sorts of menu items, for economical portion control and best food flavor. Holds up to one pound of butter.



Model #	Description	Volts	Watts	Amps
8150-RS	Butter Spreader	—	—	—
8150-RS1*	Butter Spreader, Heated	120	24	0.2

220-Volt model also available. Call for details.



Easy Grill Scraper™

Our unique scraper design has a special, ergonomic shape that puts more pressure on the blade for better results. Constructed of heavy-duty cast aluminum with a heat-treated spring steel blade. Replacement blades fit most other brands.



Model #	Description	Replacement Blades
55825	Grill Scraper	55607-6 (set of 6)



THE DIFFERENCE IS IN THE DESIGN

BusBoy by Nemco®

Commercial Food Waste Disposer Systems

Works as Tough as It Looks

BusBoy food-waste disposers are built tough to work hard and work long in the toughest foodservice environments. That means dependability.

BusBoy horsepower has proven its strength in commercial kitchens around the world. Sealed shafts prevent motor damage, and noncorrosive parts virtually eliminate the chance of a sudden breakdown. Oversized grinding tables improve speed and reduce motor strain for faster, more efficient grinding. Cast chrome alloys provide maximum grinding performance.

A Wide Range of Models Handles Every Food Waste Need

- Medium-to-large operations with heavy food-waste requirements
- Small operations or single-use kitchen stations
- Supermarkets or other sites with large, bulky waste
- Pot and pan sinks, salad and vegetable preparation tables
- Dishwashing stations

For your convenience, Nemco offers a full line of adapter kits and mounting assemblies to help you convert any competitive commercial disposer into a dependable BusBoy quickly and easily.



From the World to Your Countertop

Global
Solutions
a NEMCO FOOD EQUIPMENT company

Searching Far and Wide to Meet Your Needs

Foodservice operators everywhere know they can always turn to Nemco for smart, reliable food equipment, designed to meet their most unique menu challenges.

Introducing Global Solutions—your connection to an even bigger world of ideas in countertop food equipment. With the growing Global Solutions line, you have an even faster, more efficient pathway to finding the right product for your needs, and the assurance of knowing you still have the reliable Nemco name to back it up.

NEW! FOOD PREP EQUIPMENT

CHOPPERS

Chopper — Make quick work of onions, peppers, potatoes and all sorts of other staple produce items with this super-simple chopper. Just bring the weighted handle down in one stroke and, then, keep the veggies coming. Features an aluminum body with nonskid rubber feet for stability.

GS4150-A 1/4" Chopper

GS4150-B 3/8" Chopper



Lettuce Chopper — Turn an entire iceberg head into a crispy-fresh pile of lettuce with one motion. Cut a case of cored heads in just three minutes. Features an aluminum body with nonskid rubber feet for stability.

GS4200 1 x 1" Lettuce Chopper

GS4200-C 1/2" x 1/2" Lettuce Chopper



Wall-Mount Chopper — Save time and space with this convenient model that stays up off the counter. Features an ergonomic handle with the built-in leverage to easily cut through raw potatoes, onions and other tough produce. Made of aluminum.

GS4450-A 1/2" Wall-Mount Chopper

GS4450-B 3/8" Wall-Mount Chopper



SLICERS

Tomato Slicer — One stroke is all it takes to turn a whole tomato into multiple slices with perfectly uniform thickness for consistent portion control and minimal waste. Made of aluminum with a low base and nonskid feet for stability.

GS4100-A 3/16" Tomato Slicer

GS4100-B 1/4" Tomato Slicer



Onion Slicer — Slicing even the toughest onions is easy, thanks to an ergonomically designed handle that uses leverage. Your motion is effortless, while the pusher block does all the work. Made of aluminum with a wide base and nonskid feet for stability.

GS4250-A 3/16" Onion Slicer

GS4250-B 1/4" Onion Slicer



Rotary Slicer — Use just one tool to slice all sorts of fruits and vegetables in a wide range of thicknesses. Simply adjust the blades to the size you need, from 1/8" to 1/2". Bolt the base to the counter for stability. Then, turn an ergonomic screw to remove the slicer for easy cleaning. Made of aluminum.

GS4400 Adjustable Rotary Slicer





Model GS4560-8

Wedge Cutter

Forget using a knife. Create perfect citrus, tomato and other fruit and veggie wedges with one quick top-down.

GS4560-6 6-pc Wedge Cutter

GS4560-8 8-pc Wedge Cutter



Model GS4350

Grill Scraper

Make quick work of cleaning your griddle tops with this aluminum-cast tool that transfers user motion right to the point of attack. Turning a couple of wing nuts is all it takes to remove and replace the scraper blade.

GS4350 Grill Scraper



Model GS4300-B

Cheese Cutter

Turning a bulk cheese block into a pile of uniform slices, sticks or cubes takes only seconds with this easy-to-use device. Adjust for $\frac{3}{8}$ " or $\frac{3}{4}$ " sizes. Made of aluminum.

GS4300-B Cheese Cutter



Model GS4500

Can Opener

Take the fight of opening #10 cans and make it as easy as a Sunday drive with this ergonomic cast-iron can opener. Just place the can on the base and turn the easy-motion crank a few times. Opener mounts right to the counter's edge for stability.

GS4500 #10 Can Opener



NEW!

FOOD MERCHANDISING EQUIPMENT



Model GS1300-24



Model GS1300-16S



Model GS1410



Model GS1400-25



Model GS1405

OPEN HOT-FOOD MERCHANDISERS

Horizontal Dual-Shelf — A wide-open design lets your food sell itself by staying clearly visible and easily accessible, especially with the addition of built-in overhead shelf lighting. An adjustable thermostat gives you the control to hold your food at a preferred temperature. Features stainless-steel construction.

GS1300-16 Heated Shelf Merchandiser, Flat 16"

GS1300-24 Heated Shelf Merchandiser, Flat 24"



Slanted Dual-Shelf — Also boasts a wide-open design, but adds the element of a six-degree shelf angle that maximizes visibility and ensures 'next-in-line' items always slide forward to take the place of items removed for purchase. Features stainless-steel construction.

GS1300-16S Heated Shelf Merchandiser, Slanted 16"

GS1300-24S Heated Shelf Merchandiser, Slanted 24"



CLOSED HOT-FOOD MERCHANDISERS

Solid Shelf — A complete enclosure with no front corner posts maximizes visibility, while an adjustable thermostat allows for heating a wide variety of baked goods and other warm foods. The bottom-warming shelves, in particular, are great for keeping crusts crisp on pizzas up to 16" in diameter. Header graphics add merchandising appeal.

GS1410 Heated Food Merchandiser, 2-Shelf, Single Door

GS1415 Heated Food Merchandiser, 3-Shelf, Single Door



Wire Shelf/Pass-Through — Front and back doors ensure your merchandiser stays stocked and keeps selling by giving both your behind-the-counter staff and self-serve customers easy reach-in access. Warm, circulating air holds food above 150°F. Wire shelves are height- and angle-adjustable. Header graphics add merchandising appeal.

GS1400-16 Heated Food Merchandiser, 2-Shelf

GS1400-16-2 Heated Food Merchandiser, 2-Shelf, Pass-Thru

GS1400-25 Heated Food Merchandiser, 4-Shelf

GS1400-25-2 Heated Food Merchandiser, 4-Shelf, Pass-Thru



Wire Shelf/Front Access — An extremely compact design and super-easy-to-open hinged doors make this a perfect customer-friendly merchandiser in an already crowded countertop. Keeps pretzels, pastries and other favorites warm. Header graphics add merchandising appeal.

GS1405 Heated Food Merchandiser, 2-Shelf



NEW! COUNTERTOP OVENS



Model GS1010



Model GS1005



Model GS1200



Model GS1115



Model GS1125

MULTIPURPOSE OVENS

Manual — This is an ideal solution for expanding cooking capabilities in a kitchen where space is a premium. Manual operation allows for the full spectrum of temperature versatility. Rapid heating and recovery also make this a perfect appliance for on-demand cooking.

GS1010 Multipurpose Oven, w/Timer, Manual 17"

GS1015 Multipurpose Oven, w/o Timer, Manual 13"



Digital — Offers all the advantages of the manual unit, but with the addition of digital temperature controls that simplify operation for more inexperienced staff.

GS1005 Multipurpose Oven, Digital 13"



CONVECTION OVENS

Manual — Kitchens looking to bake in small batches will find the perfect solution in this versatile model. Features convection technology that heats food quickly and evenly, plus offers a variety of options to meet uncommon application needs.

GS1200 Convection Oven, Manual, 1/4" Pan, 3-Shelf

GS1105-17 Convection Oven, Manual, 1/2" Size, 3-Shelf - 1700w

GS1105-28 Convection Oven, Manual, 1/2" Size, 3-Shelf - 2800w

GS1110-17 Convection Oven, Manual, 1/2" Size, 4-Shelf - 1700w

GS1110-28 Convection Oven, Manual, 1/2" Size, 4-Shelf - 2800w



Manual Broiler — Diversify your menu even further with this manual countertop convection oven that offers eight different configurations and an added broiler function.

GS1115 Convection Oven w/Broiler, Manual, 1/2" Size, 3-Shelf



Manual Steam — Maximize the moistness and flavor of your fresh-baked goods with this unique countertop oven that combines convection heating with steam capabilities. Compact design that offers so much menu versatility makes this oven the hero for coffee shops, cafes, snack bars and kiosk-style eateries.

GS1120 Convection Oven w/Steam, Manual, 1/2" Size, 4-Shelf



Digital Steam — Offers all the advantages of the manual steam oven, but with the addition of digital temperature controls that simplify operation for more inexperienced staff.

GS1125 Convection Oven w/Steam, Digital, 1/2" Size, 4-Shelf

