



2022
Product Catalog

- SHELVING
- CARTS
- WALL SHELVING
- CABINETS & RACKS
- WARE HANDLING
- WORK STATIONS
- FOOD CARRIERS



VIEW CURRENT
CATALOG WITH LATEST
UPDATES

FOODSERVICE

metro.com



What's new?



NEW C5 9 & 8 Series
Simple-touch controller
pg.180



NEW Metroseal Gray
Super Erecta shelving with
gray rust resistant epoxy
pg.48



NEW Super Erecta® Hot
Heated Shelving
pg.170

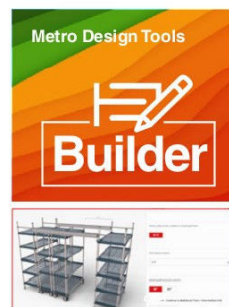

NEW Builder Design Tools
Customize in 3D
metro.com/design-tools

-  www.facebook.com/MetroFoodserviceSolutions
-  www.linkedin.com/company/intermetroindustriescorp
-  www.instagram.com/metrofoodservice
-  www.twitter.com/MetroFS
-  www.metro.com/YouTube

Corporate Headquarters
651 North Washington Street
Wilkes-Barre, PA 18705
Phone: +1 570 825 2741
Fax: +1 570 825 2852

U.S. & Canada Customer Service
Phone: 1.800.992.1776
Fax (PA): +1 800 638 9263
Fax: (CA): +1 800 638. 3292

**International Sales/
Customer Service Offices**
Middle East/Africa/India
Dubai-United Arab Emirates
Phone: +971 4 811 8286
Fax: +971 4 886 5465

Asia/Pacific
Singapore
Phone: +65 6829 5382

Latin America
Mexico
Phone: +52 33 362 778 30

Europe
The Netherlands
Phone: +31 76 587 7550
Fax: +31 76 581 1313



We put space to work.

How we make you more organized & efficient.

We offer a unique product portfolio and an expertise that is unmatched. Our understanding of you, the customer, and our ability to match a product or solution to solve a problem is proven to have a positive effect on businesses in any industry. Our trained professionals get processes on-track to store more, do more, and save more.



Conquer the day.

Our obsession to understand the customer is what drives us. The better we know how you work and what you need gives us the right tools to innovate space better. Since 1929, we've been observing customers' challenges to find ideal solutions within virtually every application.

Delivering value based products & solutions.

We continue to innovate the highest quality products in our space, utilizing unique materials and advanced production processes to deliver relevant, leading edge solutions. Born from the creation of the industry standard for wire shelving, our product breadth has evolved into a vast array of product categories including plastic & wire shelving, medical carts, storage cabinets, workstations, heated cabinets, high-density shelving, wall storage systems, stainless fabricated products and more.

We differentiate our products by the features that we build in. Be it adjustability, corrosion resistance, energy efficiency, modularity, maneuverability, ergonomics, or durability, our products provide unrivaled performance and value. These features enable us to configure, tailor, accessorize and customize these products into application-specific solutions that ensure professionals have the right tool for the job.



Contents

Polymer Shelving Solutions 10-33

- MetroMax i Shelves and Posts 12-13
- MetroMax 4 Shelves and Posts 14-15
- MetroMax Q Shelves and Posts 16-17
- MetroMax Casters 18-19
- Mobile Shelving, Carts, and Utility Carts 20-21
- MetroMax Supply and Speciality Carts 22-23
- MetroMax Platform Accessories 24-29
- MetroMax Drying Racks 30-33

Wire and Solid Shelving Solutions 34-93

- Wire/Polymer Hybrid Shelving 36-39
- Easy-Adjust Shelving and Carts 40-45
- Wire Shelving, Carts, and Trucks 46-56
- Casters for Wire Shelving 58-59
- Dollies & Plate Casters 60-62
- Accessories for Wire Shelving 63-73
- Solid Shelving and Accessories 74-76
- Light-Duty Wire Shelving and Accessories 77
- Heavy-Duty Solid Shelving and Accessories 78-79
- qwikSLOT Adjustable Shelving 80-83
- Basket Shelving and Accessories 84-89
- Storage Bins and Totes 90-93

Security, Track, and Seismic Shelving 94-117

- Security Shelving 96-99
- High-Density Track Shelving 100-110
- Vertical Extra-High Shelving 111
- Seismic Shelving 112-117

Wall Shelving 118-130

- SmartWall Grid and Wall Shelving 120-127
- Wall Mounted Shelving 128-130

Workstations and Worktables 132-147

- Smartlever Workstations 134-139
- Stainless Steel Worktables and Accessories 140-145

Utility Carts and Dunnage 146-155

- Polymer Utility Carts 148-151
- Wire & Solid Utility Carts 152-153
- Dunnage Racks and Shelves 154-155

Visit www.metro.com or call 1-800-992-1776.

Prep Tables & Application Based Units..... 156-167

PrepMate Prep Stations 158-159

SmartStation Application Based Units 160-167



Food Warming & Insulated Carriers 168-177

Super Erecta Hot Heated Shelving 170-171

Metro2Go Hot Stations 172-173

Mightylite Front Load Pan Carriers..... 174-175

Mightylite Top Load Pan Carriers..... 176

Mightylite Accessories 177



Thermal Cabinets & Racks 178-233

C5 Cabinet Line & Accessories 180-211

Heavy-Duty Heated Transport Cabinets 212-217

Heavy-Duty Mobile Refrigerators 218-221

Heated Banquet Cabinets & Accessories 222-228

Holding/Delivery/Storage Cabinets..... 229

Mobile Bun and Tray Racks 230-233



Grocery, Retail, Speciality & Ware Handling 234-258

Grocery Solutions..... 236-247

Retail Solutions..... 248-251

Beer and Wine Storage & Accessories..... 252-253

Mini Bar Restocking Cart 254

Linen Trucks & Carts 255

"Poker Chip" Dish Dollies..... 256-257

Side-Load Dish and Tray Carts 258



Terms and Conditions 259-261

Index Inside Back Cover



Select the right shelving for the job.

Innumerable Options. Imaginative Solutions.



LIFETIME



MetroMax[®] 4
All-Plastic, 100% Rust-Proof,
Removable Shelf Mats



Sectioned Solid Mats Available.

Wet Environment	Cleanability	Abrasion Resistance	Accessorization	Shelf Capacity	Relative Price	Corrosion Warranty
★★★★★	★★★★★	★★★★★	★★★	800lbs. (363kg)	\$\$\$	Lifetime

NSF MICROBAN

HEAVY DUTY



MetroMax[®] i
Heavy Duty, All-Plastic with Stainless
Steel Corners, 100% Rust-Proof,
Removable Shelf Mats



One-Piece Solid Mats Available.

Wet Environment	Cleanability	Abrasion Resistance	Accessorization	Shelf Capacity	Relative Price	Corrosion Warranty
★★★★★	★★★★★	★★★★★	★★★★★	1000lbs. (454kg)	\$\$\$\$	Lifetime

NSF MICROBAN

QUICK ADJUST



MetroMax[®] Q
All-Plastic Removable Mats with
Epoxy Coated Wire Frames and Quick
Adjustment Feature



Commonly used with All-Polymer posts.
Epoxy Coated Steel Posts also available.

Wet Environment	Cleanability	Abrasion Resistance	Accessorization	Shelf Capacity	Relative Price	Corrosion Warranty
★★★★	★★★★	★★★★	★★★	800lbs. (363kg)	\$\$\$	20 Years

NSF MICROBAN

EASY CLEAN



Super Erecta Pro[®]
All-Plastic Removable Mats with
Epoxy Coated Wire Frames



Wet Environment	Cleanability	Abrasion Resistance	Accessorization	Shelf Capacity	Relative Price	Corrosion Warranty
★★★	★★★★	★★★★	★★★★	800lbs. (363kg)	\$\$	15 Years

NSF MICROBAN

ALL-PURPOSE



Super Erecta®

Wire Shelving





Available Finishes

Chrome	Brute	Metroseal Green	Metroseal Gray	Stainless Steel	Black	White	Smoked Glass	Copper Hammer Tone
		MICROBAN®		MICROBAN®				

Wet Environment	Cleanability	Abrasion Resistance	Accessorization	Shelf Capacity	Relative Price	Corrosion Warranty
Metroseal ★★★★ Stainless Steel ★★★★★ Other ●	Metroseal ★★★★ Stainless Steel ★★★★★ Other ★★	Metroseal ★★★★ Stainless Steel ★★★★★ Other ★★★★★	★★★★★	800lbs. (363kg)	Metroseal \$ Stainless Steel \$\$\$\$ Other \$	Metroseal 12 Years

Solid Shelving
with Built-in Spill
Containment

Available Finishes

Galvanized*	Stainless Steel	Autoclave Cart Wash Stainless Steel*	NSF
-------------	-----------------	--------------------------------------	-----





*Lowered Style is not available in Galvanized or Autoclave

Wet Environment	Cleanability	Abrasion Resistance	Accessorization	Shelf Capacity	Relative Price
Stainless Steel ★★★★★ Galvanized ★★	Stainless Steel ★★★★★ Galvanized ★★★	★★★★★	★★★	800lbs. (363kg)	Stainless Steel \$\$\$\$ Galvanized \$\$



EASY ADJUST



Super Adjustable Super Erecta®

Wire Shelving
with Quick Adjustment Feature





Available Finishes

Chrome	Metroseal Green	Stainless Steel
MICROBAN®		

Wet Environment	Cleanability	Abrasion Resistance	Accessorization	Shelf Capacity	Relative Price	Corrosion Warranty
Metroseal ★★★★ Stainless Steel ★★★★★ Chrome ●	Metroseal ★★★★ Stainless Steel ★★★★★ Chrome ★	Metroseal ★★★★ Stainless Steel ★★★★★ Chrome ★★★★★	★★★★★	800lbs. (363kg)	Metroseal \$ Stainless Steel \$\$\$\$ Chrome \$	Metroseal 12 Years

HEATED



Super Erecta® Hot

Heated Shelving
with Built-in Temperature Control



Enclosure Kits Available



Flexibility	Cleanability	Adjustability	Abrasion Resistance	Max Temp.	Relative Price
★★★★★	★★★★★	★★★★★	★★★★★	200°F (93°C)	\$\$\$\$

More options available.

Recommended shelving for cooler & freezer applications.

Options for any application or budget.

Most used for:

- Coolers
- Freezers
- Standard Loads
- Mobile Applications
- Dish Areas
- Drying Racks
- Wet Areas
- Wall Shelving
- Dry Storage
- Track Shelving
- Security Shelving

Styles and finishes are available in stationary, mobile, or movable aisle track systems.



Super Erecta® Pro



Plastic Removable Mats with Epoxy Coated Wire Frames



15-YEAR
CORROSION WARRANTY



EASY-TO-CLEAN,
REMOVABLE MATS



HOLDS UP TO 800 LBS
(454kg) PER SHELF
2000 LBS (907kg) PER UNIT
1000 LBS (454kg) PER MOBILE UNIT

- DEPTHS: 14, 18, 21, 24" [355, 457, 530, 610mm]
- LENGTHS: 24, 30, 36, 42, 48, 54, 60, 72" [610, 760, 914, 1060, 1219, 1372, 1524, 1829mm]



LEARN MORE



PLAY VIDEO

MetroMax® Q



BETTER



Plastic Removable Mats with Epoxy Coated Wire Frames and Quick Adjustment Feature

20-YEAR CORROSION WARRANTY **EASY-TO-CLEAN, REMOVABLE MATS**

HOLDS UP TO 800 LBS
(454kg) PER SHELF
2000 LBS (907kg) PER UNIT
1000 LBS (454kg) PER MOBILE UNIT

- DEPTHS: 14, 18, 21, 24" [355, 457, 530, 610mm]
- LENGTHS: 24, 30, 36, 42, 48, 54, 60, 72"
[610, 760, 914, 1060, 1219, 1372, 1524, 1829mm]

MetroMax® 4



BEST



All-Plastic, 100% Rust Proof Removable Mats

LIFETIME CORROSION WARRANTY **EASY-TO-CLEAN, REMOVABLE MATS**

HOLDS UP TO 800 LBS
(363kg) PER SHELF
2000 LBS (907kg) PER UNIT
750 LBS (340kg) PER MOBILE UNIT **TEAR RESISTANT SURFACES**

- DEPTHS: 18, 21, 24 [457, 530, 610mm]
- LENGTHS: 24, 30, 36, 42, 48, 54, 60"
[610, 760, 914, 1060, 1219, 1372, 1524mm]



Take confidence to the max.

MetroMax® All-Polymer Shelving System



PLAY VIDEO

Safely Hold up to **2000 lbs.** per unit.





MetroMax Shelving

RUST PROOF POLYMER & HYBRID POLYMER/WIRE SHELVING

Polymer Shelving Solutions10-33

MetroMax i Shelves & Posts 12-13

MetroMax 4 Shelves & Posts 14-15

MetroMax Q Shelves & Posts 16-17

MetroMax Casters 18-19

Mobile Shelving, Carts, & Utility Carts 20-21

MetroMax Supply & Speciality Carts 22-23

MetroMax Platform Accessories 24-29

MetroMax Drying Racks 30-33

METROMAX® i SHELVES AND POSTS



MetroMax® i Polymer Shelving — {9.20}

Shelves

• Includes shelf with removable mats and one bag of wedges.

Nominal Width/Length (in.)	(mm)	Cat. No. Shelf w/ Grid Mats	Cat. No. Shelf w/ Solid Mats	Cat. No. High-Impact Dunnage Shelves
18x24	457x610	MX1824G	MX1824F	-
18x30	457x760	MX1830G	MX1830F	-
18x36	457x914	MX1836G	MX1836F	-
18x42	457x1060	MX1842G	MX1842F	-
18x48	457x1219	MX1848G	MX1848F	-
18x54	457x1372	MX1854G	MX1854F	-
18x60	457x1524	MX1860G	MX1860F	-
18x72	457x1829	MX1872G	MX1872F	-
24x24	610x610	MX2424G	MX2424F	-
24x30	610x760	MX2430G	MX2430F	-
24x36	610x914	MX2436G	MX2436F	MHP2436G
24x42	610x1060	MX2442G	MX2442F	-
24x48	610x1219	MX2448G	MX2448F	MHP2448G
24x54	610x1372	MX2454G	MX2454F	MHP2454G
24x60	610x1524	MX2460G	MX2460F	MHP2460G
24x72	610x1829	MX2472G	MX2472F	-

Actual Dimensions: Width: Add .25" (6mm) to nominal size. Length: Subtract .25" (6mm) from nominal size.
Standard Shelves: Maximum weight capacity evenly distributed: Up to and including 48" (1220mm) long shelf, 1000 lbs. (454kg); 54" (1372mm) and longer, 750 lbs. (340kg).
High-Impact Dunnage Shelves: maximum weight capacity evenly distributed: Up to and including 48" (1220mm) long shelf, 1200 lbs. (544kg); 900 lbs. (408kg) for 60" (1524mm).

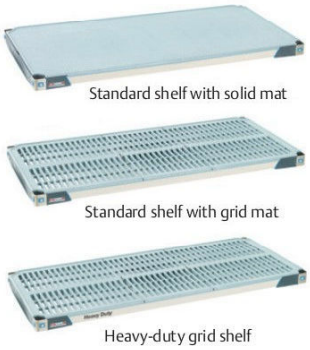

The easiest way to customize MetroMax® in 3D.



Polymer Posts

• Corrosion proof with built-in Microban antimicrobial product protection.

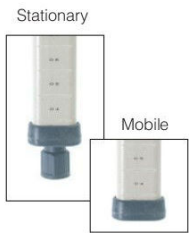

Stationary posts include a leveling foot that can be adjusted 1" (25mm).

Nominal Height (in.)	(mm)	Approx. Pkd. Wt. (lbs.) (kg)		Cat. No. Stationary Post with Leveling Foot		Cat. No. Mobile Post for Stem Caster	
		0.3	0.15	—	MX9UP		
9	228	0.3	0.15	—	MX9UP		
13	330	0.5	0.2	MX13P	MX13UP		
27	685	0.9	0.4	MX27P	MX27UP		
33	838	1.0	0.5	MX33P	MX33UP		
54	1372	1.6	0.7	MX54P	MX54UP		
63	1600	1.8	0.8	MX63P	MX63UP		
70	1778	2.0	0.9	—	MX70UP		
74	1880	2.2	1.0	MX74P	MX74UP		
86	2184	3.0	1.4	MX86P	MX86UP		

Special height cut posts are available. Dolly applications require stationary posts. Consult your Metro representative.

MetroMax® i Replacement Wedges

Bag of (4)
Cat. No. MX9985
 MetroMax® i Wedges are not compatible with original MetroMax shelves and posts.

Post Clamp

Adds stability by joining posts of two separate units together. Each unit is supported by four posts and buttressed by the adjacent unit.
Cat. No. 9994X

Foot Plate

Use to add stability to the shelving unit or to bolt units to the floor.
Cat. No. Zinc 9993Z
Cat. No. Stainless Steel 9993S

NOTE: For maximum rigidity on heavily loaded carts, steel posts may be used. See page 16 for models.

Note: MetroMax® i shelves, posts, and wedges are not compatible with original MetroMax shelves and posts.



METROMAX® i STARTER AND ADD-ON UNITS

MetroMax® i Shelving Starter and Add-On Units – {9.10}

- Starter Units consist of four polymer posts and indicated number of MetroMax i shelves.
- Add-On Units consist of two polymer posts, indicated number of shelves, and two "S" Hooks per shelf, for attaching add-on unit to starter unit in an end-to-end configuration. To attach shelves at right angles, Intermediate "S" Hook Kits must be ordered separately.

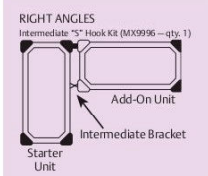
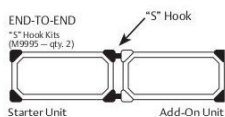

- Regular "S" Hook location
- ✕ Intermediate bracket location
- Post
- Post not required



Add-On units with "S" hooks can only be attached to shelves supported by two or more posts.



4-Tier Unit with 63" posts					
Nominal Width/Length (in./mm)	Approx. Pkd. Wt. (lbs./kg)	Cat. No. Starter Unit	Approx. Pkd. Wt. (lbs./kg)	Cat. No. Add-On Unit	
18x24	457x610	X316GX3	44.0 20.0	AX316GX3	
18x30	457x760	X326GX3	48.0 21.8	AX326GX3	
18x36	457x914	X336GX3	52.0 23.6	AX336GX3	
18x42	457x1060	X346GX3	60.0 27.2	AX346GX3	
18x48	457x1219	X356GX3	68.0 30.8	AX356GX3	
18x60	457x1524	X366GX3	84.0 38.1	AX366GX3	
18x72	457x1829	X376GX3	96.0 43.5	AX376GX3	
24x24	610x610	X516GX3	50.0 22.7	AX516GX3	
24x30	610x760	X526GX3	60.0 27.2	AX526GX3	
24x36	610x914	X536GX3	64.0 29.0	AX536GX3	
24x42	610x1060	X546GX3	72.0 32.7	AX546GX3	
24x48	610x1219	X556GX3	80.0 36.3	AX556GX3	
24x60	610x1524	X566GX3	88.0 39.9	AX566GX3	
24x72	610x1829	X576GX3	112.0 50.8	AX576GX3	

5-Tier Unit with 74" posts					
Nominal Width/Length (in./mm)	Approx. Pkd. Wt. (lbs./kg)	Cat. No. Starter Unit	Approx. Pkd. Wt. (lbs./kg)	Cat. No. Add-On Unit	
60.0	27.2	5X317GX3	55.0 24.9	5AX317GX3	
65.0	29.5	5X327GX3	60.0 27.2	5AX327GX3	
70.0	31.8	5X337GX3	65.0 29.5	5AX337GX3	
80.0	36.3	5X347GX3	75.0 34.0	5AX347GX3	
90.0	40.8	5X357GX3	85.0 38.6	5AX357GX3	
110.0	49.9	5X367GX3	105.0 47.6	5AX367GX3	
125.0	56.7	5X377GX3	120.0 54.4	5AX377GX3	
65.0	29.5	5X517GX3	60.0 27.2	5AX517GX3	
80.0	36.3	5X527GX3	75.0 34.0	5AX527GX3	
85.0	38.6	5X537GX3	80.0 36.3	5AX537GX3	
95.0	43.1	5X547GX3	90.0 40.8	5AX547GX3	
105.0	47.6	5X557GX3	100.0 45.4	5AX557GX3	
115.0	52.2	5X567GX3	110.0 49.9	5AX567GX3	
145.0	65.8	5X577GX3	140.0 63.5	5AX577GX3	

Actual Dimensions: Width: Add .25" (6mm) to nominal size.
Length: Subtract .25" (6mm) from nominal size.

5-Tier Unit with 74" posts (4) Grid (1) Solid Shelves				5-Tier Unit with 74" posts (4) Grid (1) Solid Shelves			
Nominal Width/Length (in./mm)	Cat. No. Starter Unit	Nominal Width/Length (in./mm)	Cat. No. Starter Unit	Nominal Width/Length (in./mm)	Cat. No. Starter Unit	Nominal Width/Length (in./mm)	Cat. No. Starter Unit
18x24	457x610	5X317HX3		24x24	610x610	5X517HX3	
18x36	457x914	5X337HX3		24x36	610x914	5X537HX3	
18x48	457x1219	5X357HX3		24x48	610x1219	5X557HX3	
18x60	457x1524	5X367HX3		24x60	610x1524	5X567HX3	

Actual Dimensions: Width: Add .25" (6mm) to nominal size.
Length: Subtract .25" (6mm) from nominal size.

Needed for Corner (Right Angle) Configurations

Corner Add-on "S" Hook Kits – {9.10}

For Add-on Units.



Four-tier Corner Unit
Cat. No. MXCNR4

Five-tier Corner Unit
Cat. No. MXCNR5

"S" Hook Kits – {9.25} For individual shelves.



MetroMax® i "S" Hook Kit

Add on shelving to existing units using two posts instead of four. Kit includes one "S" hook and one corner adapter plug. Two kits required per storage level when configuring units end-to-end.
Cat. No. M9995



MetroMax® i Intermediate "S" Hook Kit

Required when joining units at right angles with open corner and no post. Intermediate bracket connects a shelf corner to the front beam of the adjoining shelf. Kit includes one intermediate bracket, two "S" Hooks, and two corner adapter plugs. One required per storage level.
Cat. No. MX9996



Corner adapter (plug) fits MetroMax i

METROMAX® 4 SHELVES AND POSTS



MetroMax® 4 Polymer Shelves — [9.22]

- All-polymer shelves with removable 6" (152mm) wide shelf mats. Includes shelf with removable shelf mats and one bag of wedges.
- Compatible on the same shelving units with MetroMax i and MetroMax Q shelves.

Nominal Width	Nominal Length	Cat. No. Shelf w/ Grid Mats	Cat. No. Shelf w/ Solid Mats
(in.)	(mm)		
18x24	457x610	MAX4-1824G	MAX4-1824F
18x30	457x760	MAX4-1830G	MAX4-1830F
18x36	457x914	MAX4-1836G	MAX4-1836F
18x42	457x1060	MAX4-1842G	MAX4-1842F
18x48	457x1219	MAX4-1848G	MAX4-1848F
18x54	457x1372	MAX4-1854G	MAX4-1854F
18x60	457x1524	MAX4-1860G	MAX4-1860F
21x24	530x610	MAX4-2124G	MAX4-2124F
21x30	530x760	MAX4-2130G	MAX4-2130F
21x36	530x914	MAX4-2136G	MAX4-2136F
21x42	530x1060	MAX4-2142G	MAX4-2142F
21x48	530x1219	MAX4-2148G	MAX4-2148F
21x54	530x1372	MAX4-2154G	MAX4-2154F
21x60	530x1524	MAX4-2160G	MAX4-2160F
24x24	610x610	MAX4-2424G	MAX4-2424F
24x30	610x760	MAX4-2430G	MAX4-2430F
24x36	610x914	MAX4-2436G	MAX4-2436F
24x42	610x1060	MAX4-2442G	MAX4-2442F
24x48	610x1219	MAX4-2448G	MAX4-2448F
24x54	610x1372	MAX4-2454G	MAX4-2454F
24x60	610x1524	MAX4-2460G	MAX4-2460F

Actual Dimensions: Width: Add .5" (13mm) to nominal size. Length: Subtract .06" (1.6mm) from nominal size. **Maximum weight capacity evenly distributed:** up to and including 48" (1219mm) long shelf, 800 lbs. (363kg); 54" (1372mm) and larger, 800 lbs. (272kg).



SHELVING ASSEMBLY



MetroMax® 4 Replacement Wedges
Bag of (4)
Cat. No. MAX4-9985

For heavy loads exceeding 800 lbs.

MetroMax i shelves can be added to MetroMax 4 units.

The easiest way to customize MetroMax® in 3D.

Removable
wash-machine friendly mats.



Polymer Posts

- Corrosion proof with built-in Microban antimicrobial product protection.



Stationary posts include a leveling foot that can be adjusted 1" (25mm).

Nominal Height (in.)	Nominal Height (mm)	Approx. Pkd. Wt. (lbs.)	Approx. Pkd. Wt. (kg)	Cat. No. Stationary Post with Leveling Foot	Cat. No. Mobile Post for Stem Caster
9	228	0.3	0.15	—	MX9UP
13	330	0.5	0.2	MX13P	MX13UP
27	685	0.9	0.4	MX27P	MX27UP
33	838	1.0	0.5	MX33P	MX33UP
54	1372	1.6	0.7	MX54P	MX54UP
63	1600	1.8	0.8	MX63P	MX63UP
70	1778	2.0	0.9	—	MX70UP
74	1880	2.2	1.0	MX74P	MX74UP
86	2184	3.0	1.4	MX86P	MX86UP

Special height cut posts are available. Dolly applications require stationary posts. Consult your Metro representative.

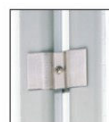

Post Clamp

Adds stability by joining posts of two separate units together. Each unit is supported by four posts and buttressed by the adjacent unit.

Cat. No. 9994X



Foot Plate

Use to add stability to the shelving unit or to bolt units to the floor.

Cat. No. Zinc 9993Z
Cat. No. Stainless Steel 9993S

SHELVING HEIGHT GUIDELINES

Shelf Depth	14" (356mm)	18" (457mm)	21" (533mm)	24" (610mm)
Maximum Allowable Post Height	63" (1600mm)	86" (2184mm)	86" (2184mm)	86" (2184mm)

Note: For stationary units with foot plates or wall brackets properly attached to the floor or wall, the maximum allowable height is 86" (2184mm).



METROMAX® 4 SHELVES AND POSTS

MetroMax® 4 Shelving Starter and Add-On Units {9.12}

- Starter Units consist of four polymer posts and indicated number of MetroMax 4 shelves.
- Add-On Units consist of two polymer posts, indicated number of shelves, and two “S” Hooks per shelf, for attaching add-on unit to starter unit in an end-to-end configuration. To attach shelves at right angles, Corner “S” Hook Kits must be ordered separately.

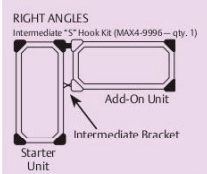
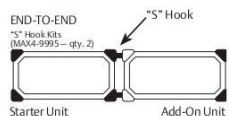

- ☐ Regular “S” Hook location
- ✕ Intermediate bracket location
- Post
- Post not required

Add-on units with “S” hooks can only be attached to shelves supported by two or more posts.



4-Shelf Unit 63" Posts			4-Shelf Unit 74" Posts			5-Shelf Unit 74" Posts		
Nominal Width/Length (in./mm)	Cat. No. Starter Unit	Cat. No. Add-On Unit	Cat. No. Starter Unit	Cat. No. Add-On Unit	Cat. No. Starter Unit	Cat. No. Add-On Unit	Cat. No. Starter Unit	Cat. No. Add-On Unit
18x24	457x610	X316G4	MF-182474G-S-4	MF-182474G-A-4	5X317G4	5AX317G4		
18x30	457x760	X326G4	MF-183074G-S-4	MF-183074G-A-4	5X327G4	5AX327G4		
18x36	457x914	X336G4	MF-183674G-S-4	MF-183674G-A-4	5X337G4	5AX337G4		
18x42	457x1060	X346G4	MF-184274G-S-4	MF-184274G-A-4	5X347G4	5AX347G4		
18x48	457x1219	X356G4	MF-184874G-S-4	MF-184874G-A-4	5X357G4	5AX357G4		
18x54	457x1372	-	MF-185474G-S-4	MF-185474G-A-4	-	-		
18x60	457x1524	X366G4	MF-186074G-S-4	MF-186074G-A-4	5X367G4	5AX367G4		
21x24	530x610	X416G4	MF-212474G-S-4	MF-212474G-A-4	5X417G4	5AX417G4		
21x30	530x760	X426G4	MF-213074G-S-4	MF-213074G-A-4	5X427G4	5AX427G4		
21x36	530x914	X436G4	MF-213674G-S-4	MF-213674G-A-4	5X437G4	5AX437G4		
21x42	530x1060	X446G4	MF-214274G-S-4	MF-214274G-A-4	5X447G4	5AX447G4		
21x48	530x1219	X456G4	MF-214874G-S-4	MF-214874G-A-4	5X457G4	5AX457G4		
21x54	530x1372	-	MF-215474G-S-4	MF-215474G-A-4	-	-		
21x60	530x1524	X466G4	MF-216074G-S-4	MF-216074G-A-4	5X467G4	5AX467G4		
24x24	610x610	X516G4	MF-242474G-S-4	MF-242474G-A-4	5X517G4	5AX517G4		
24x30	610x760	X526G4	MF-243074G-S-4	MF-243074G-A-4	5X527G4	5AX527G4		
24x36	610x914	X536G4	MF-243674G-S-4	MF-243674G-A-4	5X537G4	5AX537G4		
24x42	610x1060	X546G4	MF-244274G-S-4	MF-244274G-A-4	5X547G4	5AX547G4		
24x48	610x1219	X556G4	MF-244874G-S-4	MF-244874G-A-4	5X557G4	5AX557G4		
24x54	610x1372	-	MF-245474G-S-4	MF-245474G-A-4	-	-		
24x60	610x1524	X566G4	MF-246074G-S-4	MF-246074G-A-4	5X567G4	5AX567G4		

Actual Dimensions: Width: Add .5" (13mm) to nominal size. Length: Subtract .06" (2mm) from nominal size.



4-Shelf Starter Unit



4-Shelf Add-On Unit

Includes 8 S-Hooks



5-Shelf Unit 74" Posts (4) Grid (1) Solid

Nominal Width/Length (in./mm)	Cat. No. Starter Unit	
18x24	457x610	5X317H4
18x36	457x914	5X337H4
18x48	457x1219	5X357H4
18x60	457x1524	5X367H4

5-Shelf Unit 74" Posts (4) Grid (1) Solid

Nominal Width/Length (in./mm)	Cat. No. Starter Unit	
24x24	610x610	5X517H4
24x36	610x914	5X537H4
24x48	610x1219	5X557H4
24x60	610x1524	5X567H4

Actual Dimensions: Width: Add .5" (13mm) to nominal size. Length: Subtract .06" (2mm) from nominal size.

Needed for Corner (Right Angle) Configurations

Corner Add-on “S” Hook Kits – {9.12}

For Add-on Units.



Four-tier Corner Unit
Cat. No. MAX4-CNR4



Five-tier Corner Unit
Cat. No. MAX4-CNR5

“S” Hook Kits – {9.25} for individual shelves.



Intermediate “S” Hook Kit

MetroMax® 4 Intermediate “S” Hook Kit

Required when joining units at right angles with open corner and no post. Kit includes one intermediate bracket, one “S” Hooks, and two corner adapter plugs.
Cat. No. MAX4-9996



Standard “S” Hook Kit

MetroMax® 4 “S” Hook Kit

Kit includes one “S” hook and one corner adapter plug. Two kits required per storage level when configuring units end-to-end.
Cat. No. MAX4-9995

1.800.992.1776 • WWW.METRO.COM

METROMAX® Q SHELVES AND POSTS



MetroMax® Q Shelving — {9.21}

Shelves

• Part number includes shelf with removable mats and one bag of wedges.

Nominal Width/Length (in.)	Nominal Width/Length (mm)	Cat. No. Shelf w/ Grid Mats	Nominal Width/Length (in.)	Nominal Width/Length (mm)	Cat. No. Shelf w/ Grid Mats
14x24	355x610	MQ1424G	21x24	530x610	MQ2124G
14x30	355x760	MQ1430G	21x30	530x760	MQ2130G
14x36	355x914	MQ1436G	21x36	530x914	MQ2136G
14x42	355x1060	MQ1442G	21x42	530x1060	MQ2142G
14x48	355x1219	MQ1448G	21x48	530x1219	MQ2148G
-	-	-	21x54	530x1372	MQ2154G
14x60	457x1524	MQ1460G	21x60	530x1524	MQ2160G
14x72	457x1829	MQ1472G	21x60	530x1829	MQ2172G
18x24	457x610	MQ1824G	24x24	610x610	MQ2424G
18x30	457x760	MQ1830G	24x30	610x760	MQ2430G
18x36	457x914	MQ1836G	24x36	610x914	MQ2436G
18x42	457x1060	MQ1842G	24x42	610x1060	MQ2442G
18x48	457x1219	MQ1848G	24x48	610x1219	MQ2448G
18x54	457x1372	MQ1854G	24x54	610x1372	MQ2454G
18x60	457x1524	MQ1860G	24x60	610x1524	MQ2460G
18x72	457x1829	MQ1872G	24x60	610x1829	MQ2472G

Actual Dimensions: Width: Add .37" (10mm) to nominal size.
 Length: Subtract .19" (5mm) from nominal size.
 Maximum weight capacity evenly distributed: Up to and including 48" (1220mm) long shelf, 800 lbs. (363kg); 54" (1372mm) and longer, 600 lbs.(272kg).

The easiest way to customize MetroMax® in 3D.



Removable wash-machine friendly mats.

Posts

- Preferred Polymer posts are corrosion proof with built-in Microban antimicrobial product protection.
- Epoxy-coated steel and polymer posts have Microban antimicrobial product protection.
- Stationary posts include an adjustable leveling foot to compensate for uneven floors. Feet adjust 1" (25mm).
- When mounting a shelving unit to a dolly base, stationary posts are used.

Nominal Height (in.) (mm)	Approx. Pkd. Wt. (lbs.) (kg)	STEEL		POLYMER					
		Cat. No. Stationary Post with Leveling Foot	Cat. No. Mobile Post for Stem Caster	Approx. Pkd. Wt. (lbs.) (kg)	Cat. No. Stationary Post with Leveling Foot	Cat. No. Mobile Post for Stem Caster			
9	228	0.3	0.15	—	—	—	MX9UP		
13	370	1.0	0.5	MQ13PE	MQ13UPE	0.5	0.2	MX13P	MX13UP
27	685	2.0	0.9	MQ27PE	MQ27UPE	0.9	0.4	MX27P	MX27UP
33	875	2.5	1.1	MQ33PE	MQ33UPE	1.0	0.5	MX33P	MX33UP
54	1370	4.0	1.8	MQ54PE	MQ54UPE	1.6	0.7	MX54P	MX54UP
63	1585	4.5	2.0	MQ63PE	MQ63UPE	1.8	0.8	MX63P	MX63UP
70	1778	5.0	2.3	—	MQ70UPE	—	—	—	—
74	1890	5.5	2.5	MQ74PE	MQ74UPE	2.2	1.0	MX74P	MX74UP
86	2195	6.5	2.9	MQ86PE	MQ86UPE	3.0	1.4	MX86P	MX86UP

Special height cut posts are available. Consult your Metro representative. Dolly applications require stationary posts.

MetroMax® Q Replacement Wedges
 Bag of (4)
 Cat. No. MQ9985
 MetroMax® Q Wedges are compatible with original MetroMax Q shelves and posts.

SHELVING HEIGHT GUIDELINES				
Shelf Depth	14" (356mm)	18" (457mm)	21" (533mm)	24" (610mm)
Maximum Allowable Post Height	63" (1600mm)	86" (2184mm)	86" (2184mm)	86" (2184mm)

Note: For stationary units with foot plates or wall brackets properly attached to the floor or wall, the maximum allowable height is 86" (2184mm).





METROMAX® Q STARTER AND ADD-ON UNITS

MetroMax® Q Shelving Starter and Add-On Units — {9.11}

- Starter Units consist of four polymer posts and indicated number of MetroMax Q shelves.
- Add-On Units consist of two epoxy-coated steel posts, indicated number of shelves, and two “S” Hooks per shelf, for attaching shelf to adjacent unit in an end-to-end configuration. To attach shelves at right angles, Intermediate “S” Hook Kits must be ordered separately.

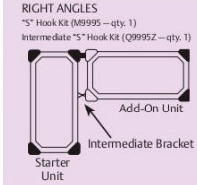
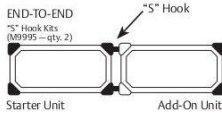

- Regular “S” Hook location
- ✗ Intermediate bracket location
- Post
- Post not required

Add-On units with “S” hooks can only be attached to shelves supported by two or more posts.



Nominal Width/Length (in./mm)	4-Shelf Unit 63” Posts		4-Shelf Unit 74” Posts		5-Shelf Unit 74” Posts	
	Cat. No. Starter Unit	Cat. No. Add-On Unit	Cat. No. Starter Unit	Cat. No. Add-On Unit	Cat. No. Starter Unit	Cat. No. Add-On Unit
18x24 457x610	Q316G3	AQ316G3	MQ-182474G-S-4	MQ-182474G-A-4	5Q317G3	5AQ317G3
18x30 457x760	Q326G3	AQ326G3	MQ-183074G-S-4	MQ-183074G-A-4	5Q327G3	5AQ327G3
18x36 457x914	Q336G3	AQ336G3	MQ-183674G-S-4	MQ-183674G-A-4	5Q337G3	5AQ337G3
18x42 457x1060	Q346G3	AQ346G3	MQ-184274G-S-4	MQ-184274G-A-4	5Q347G3	5AQ347G3
18x48 457x1219	Q356G3	AQ356G3	MQ-184874G-S-4	MQ-184874G-A-4	5Q357G3	5AQ357G3
18x54 457x1372	-	-	MQ-185474G-S-4	MQ-185474G-A-4	-	-
18x60 457x1524	Q366G3	AQ366G3	MQ-186074G-S-4	MQ-186074G-A-4	5Q367G3	5AQ367G3
18x72 457x1829	Q376G3	AQ376G3	MQ-187274G-S-4	MQ-187274G-A-4	5Q377G3	5AQ377G3
21x24 530x610	Q416G3	AQ416G3	MQ-212474G-S-4	MQ-212474G-A-4	5Q417G3	5AQ417G3
21x30 530x760	Q426G3	AQ426G3	MQ-213074G-S-4	MQ-213074G-A-4	5Q427G3	5AQ427G3
21x36 530x914	Q436G3	AQ436G3	MQ-213674G-S-4	MQ-213674G-A-4	5Q437G3	5AQ437G3
21x42 530x1060	Q446G3	AQ446G3	MQ-214274G-S-4	MQ-214274G-A-4	5Q447G3	5AQ447G3
21x48 530x1219	Q456G3	AQ456G3	MQ-214874G-S-4	MQ-214874G-A-4	5Q457G3	5AQ457G3
21x54 530x1372	-	-	MQ-215474G-S-4	MQ-215474G-A-4	-	-
21x60 530x1524	Q466G3	AQ466G3	MQ-216074G-S-4	MQ-216074G-A-4	5Q467G3	5AQ467G3
21x72 530x1829	Q476G3	AQ476G3	MQ-217274G-S-4	MQ-217274G-A-4	5Q477G3	5AQ477G3
24x24 610x610	Q516G3	AQ516G3	MQ-242474G-S-4	MQ-242474G-A-4	5Q517G3	5AQ517G3
24x30 610x760	Q526G3	AQ526G3	MQ-243074G-S-4	MQ-243074G-A-4	5Q527G3	5AQ527G3
24x36 610x914	Q536G3	AQ536G3	MQ-243674G-S-4	MQ-243674G-A-4	5Q537G3	5AQ537G3
24x42 610x1060	Q546G3	AQ546G3	MQ-244274G-S-4	MQ-244274G-A-4	5Q547G3	5AQ547G3
24x48 610x1219	Q556G3	AQ556G3	MQ-244874G-S-4	MQ-244874G-A-4	5Q557G3	5AQ557G3
24x54 610x1372	-	-	MQ-245474G-S-4	MQ-245474G-A-4	-	-
24x60 610x1524	Q566G3	AQ566G3	MQ-246074G-S-4	MQ-246074G-A-4	5Q567G3	5AQ567G3
24x72 610x1829	Q576G3	AQ576G3	MQ-247274G-S-4	MQ-247274G-A-4	5Q577G3	5AQ577G3



4-Shelf Starter Unit



4-Shelf Add-On Unit

Includes 8 S-Hooks

“S” Hook Kits — For individual shelves.



“S” Hook
Cat. No. M9995

MetroMax® Q “S” Hook Kit — {9.25}

Add on shelving using two posts instead of four. Includes one “S” hook. Two kits required per level when configuring units end-to-end.
Cat. No. M9995

Note: Collar/hole plug is designed for use with MetroMax i shelves only.



Intermediate “S” Hook Kit
Cat. No. Q9995Z

MetroMax® Q Intermediate “S” Hook Kit

Use when configuring MetroMax Q Starter and Add-On Units at right angles.

Cat. No. Q9995Z

METROMAX® HANDLES & CASTERS



Handles

- Add handles on mobile units to improve maneuverability and ergonomics.
- Compatible with MetroMax® i, MetroMax® 4, and MetroMax® Q units.
- Corrosion-proof Type 304 stainless steel construction.



Tri-Lobal Adapters
Included with handles.

Tri-Lobal Adapter Replacements

Cat. No. MTLA
Bag of 4 assemblies

MTLA adapters are designed to work with MetroMax i, MetroMax 4, and MetroMax Q and are not compatible with original MetroMax.

Extended Handle — {9.25}

Fits Shelf Depth (in.) (mm)		Extension Depth (Post to Edge of Handle) (in.) (mm)		Approx. Pkd. Wt (lbs.) (kg)		i, 4, and Q Cat. No.	
18	457	4.5	113	2.5	1.1	MEH18S	
24	610	4.5	113	2.8	1.3	MEH24S	

NOTE: Stainless steel fasteners are provided with each handle to secure the handle to the post for heavier duty applications



Easy-Grip Handle — {9.25}

Fits Shelf Depth (in.) (mm)		Extension Depth (Post to Edge of Handle) (in.) (mm)		Approx. Pkd. Wt (lbs.) (kg)		i, 4, and Q Cat. No.	
18	457	6	151	2.5	1.1	MERGH18S	
24	610	6	151	3.0	1.4	MERGH24S	

NOTE: Stainless steel fasteners are provided with each handle to secure the handle to the post for heavier duty applications



MetroMax® Stem Casters — {9.25}

For use with either polymer or steel stem caster posts.

- Promotes easy cleaning. Casters allow shelving units to be moved easily for access to floors and walls.
- Efficient Transport: Create a cart to efficiently move supplies throughout a facility or campus.

Casters for Dry Areas



5MPX

Standard Stem Casters — {9.25}

- Plated caster horns and hardware. Bumper included with each caster.
- Swivel, Swivel with Brakes, and Rigid Caster options available.

Wheel Diameter (in.) (mm)	Face (in.) (mm)	Load Rating (lbs.) (kg)	Type	Wheel Tread	Temperature Range (Continuous Usage) (Fahrenheit) (Celsius)	Approx. Pkd. Wt (lbs.) (kg)	Cat. No.	Each		
5	1 1/4	32	200 90	Stem/Swivel	Resilient, Flat	-20°-160° -29°-71°	2 1/2	1.1	5MX	32.50
5	1 1/4	32	200 90	Stem/Brake	Resilient, Flat	-20°-160° -29°-71°	2 3/8	1.2	5MBX	39.50
5	1 1/4	32	200 90	Stem/Rigid*	Resilient, Flat	-20°-160° -29°-71°	3 1/2	1.5	5MRX	39.50
5	1 1/4	32	250 113	Stem/Swivel	High Modulus Donut	-20°-180° -29°-82°	2 1/2	1.1	5MDXA	51.50
5	1 1/4	32	250 113	Stem/Brake	High Modulus Donut	-20°-180° -29°-82°	2 3/8	1.2	5MDBXA	58.00
5	1 1/4	32	250 113	Stem/Rigid*	High Modulus Donut	-20°-180° -29°-82°	2 3/8	1.1	5MDRXA	58.00
5	1 1/4	32	300 135	Stem/Swivel	Polyurethane, Flat	-20°-180° -29°-82°	2 1/8	0.9	5MPX	32.50
5	1 1/4	32	300 135	Stem/Brake	Polyurethane, Flat	-20°-180° -29°-82°	2 1/4	1	5MPBX	40.00
5	1 1/4	32	300 135	Stem/Rigid*	Polyurethane, Flat	-20°-180° -29°-82°	2	0.9	5MPRX	40.00

*Note: Rigid casters are held in place by a connecting channel. When ordering, shelf width must be provided. Rigid connecting channel (stainless steel): Cat. No. 18RS, 21RS, or 24RS.



Casters for Wet or Corrosive Areas



BETTER



5PCX

5PCBX

Polymer Stem Casters — {9.25}

Corrosion resistance and enhanced durability. Appropriate for all medium-duty mobile applications. Bumpers included.

- All-polymer horn, stainless axle, and hardware. 5" (127mm) diameter polyurethane, flat wheel.
- Sleeve style axle bearing and optional toe-operated brake mechanism
- Antimicrobial options have a tread with built-in antimicrobial product protection.

Wheel Diameter (in.) (mm)	Face (in.) (mm)	Load Rating (lbs.) (kg)	Type	Temperature Range (Continuous Usage) (Fahrenheit) (Celsius)	Approx. Pkct. Wt. (lbs.) (kg)	Cat. No.	Cat. No. Antimicrobial
5 127	1.25 32	300 135	Stem/Swivel	-20°-120° -29°-49°	2 0.9	5PCX	5PCXM
5 127	1.25 32	300 135	Stem/Brake	-20°-120° -29°-49°	2 0.9	5PCBX	5PCBXM
5 127	1.25 32	300 135	Stem/Rigid*	-20°-120° -29°-49°	2 0.9	5PCRX	—

*Note 1: Rigid casters are held in place by a connecting channel. When ordering, shelf width **must** be provided. Rigid connecting channel (aluminum) for 5PCRX caster: Cat. No. P18RC, P21RC, P24RC.
 Note 2: Not suitable for cart wash and autoclave applications.

BEST



5MPXGSA

5MPBXGSA

Stainless Steel Cart-Washable Stem Casters — {9.25}

- Stainless horn, axle, and stem with sealed bearings. Bumper included with each caster.

Wheel Diameter (in.) (mm)	Face (in.) (mm)	Load Rating (lbs.) (kg)	Type	Wheel Tread	Temperature Range (Continuous Usage) (Fahrenheit) (Celsius)	Approx. Pkct. Wt. (lbs.) (kg)	Cat. No.
5 127	1.25 32	300 135	Stem/Swivel	Polyurethane, Flat	-20°-180° -29°-82°	2.12 0.9	5MPXGSA
5 127	1.25 32	300 135	Stem/Brake	Polyurethane, Flat	-20°-180° -29°-82°	2.25 1	5MPBXGSA
5 127	1.25 32	300 135	Stem/Rigid*	Polyurethane, Flat	-20°-180° -29°-82°	2 0.9	5MPRXGSA

*Note: Rigid casters are held in place by a connecting channel. When ordering, shelf width **must** be provided. Rigid connecting channel (stainless steel): Cat. No. 18RS, 21RS, or 24RS.

Rigid stem casters are often ordered two per unit for improved tracking and handling. Rigid caster channel are provided with each two rigid stem casters at no charge.



Replacement Bumper
 Tri-lobal polymer or steel post.
 Cat. No. M9992DBX



METROMAX® SHELVING CARTS



MetroMax® i
4-Tier with Open Grid
or Solid Shelves



MetroMax® i
5-Tier with Solid Bottom Shelf

MetroMax® i — Stem Caster Carts — {9.13}

- Corrosion proof shelves and posts; removable polymer mats.
- 4 shelf units consist of 4 shelves, polymer posts, wedge connectors and polyurethane casters.
- 5 shelf units consist of 5 shelves, polymer posts, wedge connectors and polyurethane casters.
- Weight Capacity of cart: models with polyurethane casters: 900 lbs. (408kg)



*Shelves & Posts Only



4-Shelf Unit

Unit Height 67.31 (1710mm)

Nominal Width/Length (in.)	Nominal Width/Length (mm)	Approx. Pkd. Wt. (lbs.) (kg)		Open Grid Mats 2-Swivel, 2-Brake Polyurethane Casters		Solid Mats 2-Swivel, 2-Brake Polyurethane Casters	
		(lbs.)	(kg)	Cat. No.	Cat. No.		
18x36	457x914	74	33	X336EGX3	X336EFX3		
18x48	457x1219	86	38	X356EGX3	X356EFX3		
18x60	457x1524	98	44	X366EGX3	X366EFX3		
24x36	610x914	82	37	X536EGX3	X536EFX3		
24x48	610x1219	98	44	X556EGX3	X556EFX3		
24x60	610x1524	114	51	X566EGX3	X566EFX3		

5-Shelf Solid Bottom Unit

Unit Height 79.31 (2015mm)

Approx. Pkd. Wt. (lbs.) (kg)	Cat. No. 2-Swivel, 2-Brake Polyurethane Casters	
	(lbs.)	(kg)
82	37	5X337EGX3
109	49	5X357EGX3
121	55	5X367EGX3
102	46	5X537EGX3
123	56	5X557EGX3
141	63	5X567EGX3



MetroMax® 4
5-Tier with Open Grid and
Bottom Solid Shelf



MetroMax® 4
4-Tier with Open Grid Shelves

MetroMax® 4 — Stem Caster Carts — {9.12}

- Corrosion proof shelves and posts; removable polymer mats.
- 4 shelf units consist of four shelves, polymer posts, wedge connectors and polyurethane casters with polymer horns.
- 5 shelf units consist of 5 shelves, polymer posts, wedge connectors and polyurethane casters with polymer horns.
- Weight Capacity of cart: models with polyurethane casters: 750 lbs. (340kg)



*Shelves & Posts Only



4-Tier Open Grid Mats

Unit Height 67.31 (1710mm)

Nominal Width/Length (in.)	Nominal Width/Length (mm)	Approx. Pkd. Wt. (lbs.) (kg)		Cat. No. 2-Swivel, 2-Brake Polyurethane Casters
		(lbs.)	(kg)	
18x36	457x914	50.6	22.9	X336PG4
18x48	457x1219	58.3	26.5	X356PG4
18x60	457x1524	66.6	30.2	X366PG4
24x36	610x914	57.2	25.9	X536PG4
24x48	610x1219	67.6	30.7	X556PG4
24x60	610x1524	77.2	35.0	X566PG4

5-Tier w/ Solid Bottom

Unit Height 79.31 (2015mm)

Approx. Pkd. Wt. (lbs.) (kg)	Cat. No. 2-Swivel, 2-Brake Polyurethane Casters	
	(lbs.)	(kg)
61.0	27.7	5X337PG4
70.7	32.1	5X357PG4
81.0	36.8	5X367PG4
69.3	31.4	5X537PG4
82.3	37.3	5X557PG4
94.3	42.8	5X567PG4



METROMAX® SHELVING CARTS & UTILITY CARTS



MetroMax® Q
4-Tier with Open Grid
(5-Tier available)



Safely Hold up to
900 lbs.
per mobile unit.



*Shelves Only.
Posts are Lifetime.



Solid bottom shelf and
5PCX/5PCBX casters

MetroMax® Q— Stem Caster Cart, Open Grid Shelves — {9.12}

- Quick adjust shelves with removable polymer shelf mats.
- 4 shelf units consist of 4 open grid shelves, polymer posts, wedge connectors, and choice of rust resistant or general purpose casters (2) Swivel (2) Brake.
- 5 shelf units consist of 4 open grid shelves, 1 solid shelf, polymer posts, wedge connectors, and choice of rust resistant or general purpose casters (2) Swivel (2) Brake.
- Mobile cart weight capacity rated at 900 lbs. (408kg). All casters have a polyurethane tread.

4-Shelf 67.31" Unit

with Open Grid Mats

Nominal Width/Length (in.)	Nominal Width/Length (mm)	Cat. No. Polymer Caster Polyurethane Tread	Cat. No. Plated Caster Polyurethane Tread
18x36	457x914	MQ-183663G-MP-4	Q336EG3
18x42	457x1060	MQ-184263G-MP-4	-
18x48	457x1219	MQ-184863G-MP-4	Q356EG3
18x60	457x1524	MQ-186063G-MP-4	Q366EG3
21x36	530x914	MQ-213663G-MP-4	Q436EG3
21x42	530x1060	MQ-214263G-MP-4	-
21x48	530x1219	MQ-214863G-MP-4	Q456EG3
21x60	530x1524	MQ-216063G-MP-4	Q466EG3
24x36	610x914	MQ-243663G-MP-4	Q536EG3
24x42	610x1060	MQ-244263G-MP-4	-
24x48	610x1219	MQ-244863G-MP-4	Q556EG3
24x60	610x1524	MQ-246063G-MP-4	Q566EG3

4-Shelf 75.31" Unit

with Open Grid Mats

Cat. No. Polymer Caster Polyurethane Tread	Cat. No. Plated Caster Polyurethane Tread
MQ-183670G-MP-4	-
MQ-184270G-MP-4	-
MQ-184870G-MP-4	-
MQ-186070G-MP-4	-
MQ-213670G-MP-4	-
MQ-214270G-MP-4	-
MQ-214870G-MP-4	-
MQ-216070G-MP-4	-
MQ-243670G-MP-4	-
MQ-244270G-MP-4	-
MQ-244870G-MP-4	-
MQ-246070G-MP-4	-

5-Shelf 79.31" Unit

with Open Grid Mats

Cat. No. Polymer Caster Polyurethane Tread	Cat. No. Plated Caster Polyurethane Tread
MQ-183674G-MP-5	5Q337EG3
-	-
MQ-184874G-MP-5	5Q357EG3
MQ-186074G-MP-5	5Q367EG3
-	-
-	-
MQ-243674G-MP-5	5Q537EG3
-	-
MQ-244874G-MP-5	5Q557EG3
MQ-246074G-MP-5	5Q567EG3

MetroMax® i— Utility Carts

- Corrosion proof shelves, polymer posts, and Type 304 stainless steel handle.
- Corrosion resistant 5PCX casters with 5" (127mm) polyurethane wheels, polymer horns, and stainless steel axles.
- 39.25" (997mm) tall. Weight capacity of cart: 900 lbs. (408kg) evenly distributed.

Nominal Width/Length (in.)	Nominal Width/Length (mm)	Actual Width/Length (in.)	Actual Width/Length (mm)	Description	Approx. Pkd. Wt. (lbs.)	Approx. Pkd. Wt. (kg)	Cat. No.
18x30	457x760	20.31 x 34.5	516 x 876	2-shelf	35.5	15.8	MXUC1830G-25
24x36	610x914	26.31 x 40.5	668 x 1029	2-shelf	46.0	20.5	MXUC2436G-25
18x30	457x760	20.31 x 34.5	516 x 876	3-shelf	46.0	20.5	MXUC1830G-35
24x36	610x914	26.31 x 40.5	668 x 1029	3-shelf	61.5	27.5	MXUC2436G-35



MetroMax® Q— Utility Carts

- Quick adjust corrosion resistant shelves and polymer posts.
- Corrosion proof Type 304 stainless steel handle.
- Includes four 5PCX casters with 5" (127mm) polyurethane wheels.
- 39.25" (997mm) tall. Weight capacity of cart: 900 lbs. (408kg) evenly distributed.

Nominal Width/Length (in.)	Nominal Width/Length (mm)	Actual Width/Length (in.)	Actual Width/Length (mm)	Description	Approx. Pkd. Wt. (lbs.)	Approx. Pkd. Wt. (kg)	Cat. No.
18x30	457x760	20.31 x 34.5	516 x 876	2-shelf	35.5	15.8	MQUC1830G-25
24x36	610x914	26.31 x 40.5	668 x 1029	2-shelf	46.0	20.5	MQUC2436G-25
18x30	457x760	20.31 x 34.5	516 x 876	3-shelf	46.0	20.5	MQUC1830G-35
24x36	610x914	26.31 x 40.5	668 x 1029	3-shelf	61.5	27.5	MQUC2436G-35



1.800.992.1776 • WWW.METRO.COM

METROMAX® I SUPPLY & SPECIALTY CARTS



ECP55CX3 — Standard (Par Level)



ECT55CX3 — Standard Transport/Exchange



ECT55DX3 — Deluxe Transport/Exchange

MetroMax® i Exchange Carts

MetroMax polymer carts provide a smooth surface that won't snag sterile packs or sealed supplies. The shelves also contain Microban antimicrobial protection that keeps the shelves cleaner between cleanings (see metro.com/what-is-microban). Carts within each series (as noted) feature dividers, ledges, enclosure panels, MetroMax slides and tote boxes in various combinations all of which can be removed and reconfigured to adapt to changes in supply, volume, and packaging.

Par Level/Stock

For moveable storage of supplies in nursing units and other functional departments. Par Level carts utilize stem casters to provide a smaller footprint for more efficient space utilization in storage areas.

Standard

Includes four open grid shelves, one solid bottom shelf, polymer posts, four polyurethane stem casters (2 with brakes) and six label holders.

Shelf Width/Length (mm)		Overall Height (mm)		Cat. No.
18x48	457x1219	67.31	1710	ECP35CX3
18x60	457x1524	67.31	1710	ECP36CX3
24x48	610x1219	67.31	1710	ECP55CX3
24x60	610x1524	67.31	1710	ECP56CX3

Deluxe

Includes four open grid shelves, one solid bottom shelf, polymer posts, four polyurethane stem casters (2 with brakes), side and back enclosure panels, MetroMax tote slides, 6" (152mm) deep tote boxes with dividers, shelf dividers and twelve label holders.

Shelf Width/Length (mm)	Overall Height (mm)	Tote Boxes 6" (152mm) Deep	Shelf Dividers	Super Slides	Cat. No.
24x48 610x1219	67.31 1710	2	4	1	ECP55DX3
24x60 610x1524	67.31 1710	4	6	2	ECP56DX3

Transport/Exchange

For transport and exchange of supplies or linens from Central Supply or the Laundry to nursing units and other functional departments. Transport carts utilize a dolly base to endure the rigors encountered in the daily distribution of products throughout healthcare facilities.

Standard

Includes four open grid shelves, one solid bottom shelf, polymer posts, aluminum dolly frame with wraparound bumper, 8" (203mm) high modulus donut casters (two with swivel-locks), and six label holders.

Shelf Width/Length (mm)		Overall Height (mm)		Cat. No.
24x48	610x1219	71.94	1827	ECT55CX3
24x60	610x1524	71.94	1827	ECT56CX3

Deluxe

Includes four open grid shelves, one solid bottom shelf, polymer posts aluminum dolly frame with wraparound bumper, 8" (203mm) high modulus donut casters (two with swivel-locks), side and back enclosure panels, MetroMax tote slides, 6" (152mm) deep tote boxes with dividers, shelf dividers and twelve label holders.

Shelf Width/Length (mm)	Overall Height (mm)	Tote Boxes 6" (152mm) Deep	Shelf Dividers	Super Slides	Cat. No.
24x48 610x1219	71.94 1827	2	4	1	ECT55DX3
24x60 610x1524	71.94 1827	4	6	2	ECT56DX3

✓ Indicates antimicrobial product.



METROMAX® I SUPPLY & SPECIALTY CARTS

Extended Handles for MetroMax® i Mobile Systems — {9.25}

These contoured stainless steel handles attach easily to 18" or 24" (457 or 610mm) MetroMax® carts, dolly trucks and other mobile applications.

Fits Unit Width (in./mm)		Approx. Pkd. Wt. (lbs./kg)		Cat. No.
18	457	2.25	1.0	MEH18S
24	610	2.5	1.1	MEH24S



Extended Handle

MetroMax i® Supply Storage System

Baskets have semi-open front for easy access. Dividers adjust horizontally within the basket to accept various size items. Continuous label holders identify basket contents.

Description	Height/Width/Length (in./mm)		Total Baskets Per Cart	Casters	Cat. No.
	(in.)	(mm)			
Open Cart	24x24x60	610x610x1524	4	*	MXIV1
Open Cart with Top Shelf	24x24x69	610x610x1753	4	*	MXIV2
Open Cart	24x42x60	610x1066x1524	8	†	MXIV4
Open Cart with Top Shelf	24x42x69	610x1066x1753	8	†	MXIV5
Open Cart	24x60x60	610x1524x1524	12	†	MXIV6
Open Cart with Top Shelf	24x60x69	610x1524x1753	12	†	MXIV7

*Four 5" (127mm) poly casters: two swivel, two with brakes.
 †5" (127mm) poly casters on dolly frame; two swivel, one swivel with brake, and one rigid.

Accessories

Description	Size (in./mm)		Cat. No.
	(in.)	(mm)	
Basket* with Label Holder	18.5x24.5x10	470x622x254	IVB1
Divider	9	229	IVBD

*Basket weight capacity is 35 lbs. (16kg).

Perfect for: **Healthcare**
 Exchange System, Par Level Storage, Bulk Storage in Central Supply, Pharmacy Admixture, I.C.U. and E.R. Storage.



MXIV1 (includes accessories as shown)



IVB1 (shown with optional Divider)



Baskets fit on frames level or at a 10° angle.

METROMAX® ACCESSORIES



Organize with accessories.

Organize supplies to improve operational efficiencies.

- Well-organized storage results in fewer expired supplies and less waste.
- Innovative shelf and accessory designs have smooth surfaces that protect vacuum sealed and other packaged items from damage.
- Flexible compartments help sort supplies for faster access and maximize the use of storage space.

A Dividers **B Ledges** **C Enclosure Panels** **D Metro Totes** **E Metro Bins**



Flexible Compartments

Dividers and Ledges can be used to create flexible compartments that most efficiently use available storage space. When combined with open grid shelves this minimizes dust accumulation. Bins offer removable compartmentalized storage for easy access or as part of an exchange system. See page 72 for Bin options.

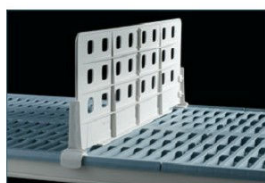

8" (203mm) Shelf Dividers — Standard Duty — {9.25}

- Use to create organized compartments or to simply separate shelf contents.
- Easily repositioned on grid and solid shelves.
- Corrosion-proof polymer (high-density polypropylene).
- Three-piece design — Ships assembled.

Nominal Length (in.) (mm)	i		4		Q	
	Cat. No.		Cat. No.		Cat. No.	
18 457	MXD18-8		MAX4-D18-8		MQD18-8	
24 610	MXD24-8		MAX4-D24-8		MQD24-8	

*Note: Can be retrofitted to original MetroMax and MetroMax Q.

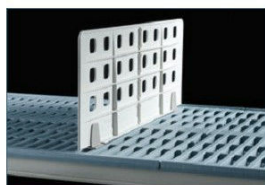

Universal Shelf Dividers — Light Duty, for open grid shelves — {9.25}

- For use with grid shelves (MetroMax i, MetroMax 4, MetroMax Q, and Super Erecta Pro), Super Erecta wire shelves, and Super Adjustable wire shelves.
- Easiest divider to install.
- Maximum flexibility: Can be repositioned along the entire shelf.
- Each divider includes a panel and two clips to connect to any open grid or wire shelf. Does not attach to solid shelves.
- Corrosion proof.

8" (203mm) Divider

Nominal Length (in.) (mm)	Fits Shelf Depth	Approx		i, 4, and Q Cat. No.
		Pkd. Wt. (lbs.)	(kg)	
18 457	18", 21" (457, 530mm)	1.3	0.6	MUD18-8
24 610	24" (610mm)	1.6	0.7	MUD24-8

*Note: Can be retrofitted to original MetroMax and MetroMax Q.
Additional clips: Cat. No DCLIP, 2 per bag.



METROMAX® ACCESSORIES

Universal 4" (102mm) Shelf Dividers — {9.25}

- Maximum flexibility: Can be repositioned along the entire shelf.
- Three-piece design; clips connect to any open grid or wire shelf; divider panel then drops into place. Does not attach to solid shelves.
- Corrosion-proof polymer (high-density polypropylene).

Cat No.	Fits Shelf Depth	Nominal Height		Nominal Length		Sold as
		(in.)	(mm)	(in.)	(mm)	
MUD24H4-4PK	24" (610mm)	4	102	24	610	4 Pack

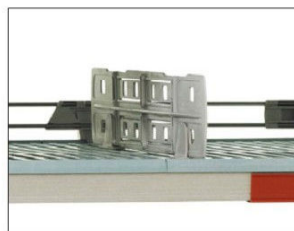

Shelf-to-Shelf Dividers — {9.25}

- Full height dividers efficiently compartmentalize the space between two shelves
- Smooth surfaces protect packaged items from damage.
- Corrosion proof.
- Compatible with open grid polymer shelves, Super Erecta wire shelves, and Super Adjustable wire shelves. Does not work with solid shelves.

Fits Shelf Depth		Nominal Height		Approx. Pkd. Wt.		i, 4, and Q	
(in.)	(mm)	(in.)	(mm)	(lbs.)	(kg)	Cat. No.	
18, 21	457, 530	16	406	2.3	1.0	MD18-16	
18, 21	457, 530	20	508	2.5	1.1	MD18-20	
18, 21	457, 530	24	610	3.8	1.7	MD18-24	
24	610	16	406	2.8	1.2	MD24-16	
24	610	20	508	3.0	1.3	MD24-20	
24	610	24	610	4.4	2.0	MD24-24	

*Note: Can be retrofitted to original MetroMax and MetroMax Q shelves.
 *Note: -16 parts have three panels, -20 parts have four panels, -24 parts have five panels.



2" (51mm) Stackable Shelf Ledges — {9.25}

- Prevent items from falling off shelves.
- Snap on and off quickly. Easily stacked to contain larger items.
- Corrosion proof polymer (high-density polypropylene) and Type 304 stainless steel.
- Ships assembled.

Nominal Length	Type	i		4		Q	
		Cat. No.	Cat. No.	Cat. No.	Cat. No.		
18 457	Side	MXLS18-2S	MAX4-LS18-2S	MQLS18-2S			
21 530	Side	—	MAX4-LS21-2S	MQLS21-2S			
24 610	Side	MXLS24-2S	MAX4-LS24-2S	MQLS24-2S			
24 610	Back	MXL24-2S	MAX4-L24-2S	MQL24-2S			
30 760	Back	MXL30-2S	MAX4-L30-2S	MQL30-2S			
36 914	Back	MXL36-2S	MAX4-L36-2S	MQL36-2S			
42 1066	Back	MXL42-2S	MAX4-L42-2S	MQL42-2S			
48 1219	Back	MXL48-2S	MAX4-L48-2S	MQL48-2S			
54 1370	Back	MXL54-2S	MAX4-L54-2S	MQL54-2S			
60 1524	Back	MXL60-2S	MAX4-L60-2S	MQL60-2S			
72 1829	Back	MXL72-2S	—	MQL72-2S			

*Note: MetroMax i wire ledges can be retrofitted to original MetroMax.
 *Note: MetroMax Q wire ledges (MQ-) cannot be retrofitted to original MetroMax Q.



4" (102mm) Solid Clear Stackable Shelf Ledges — {9.26}

- Solid design helps contain small items.
- Clear plastic allows light penetration and visible access to supplies.
- Corrosion proof.
- Ships assembled.

Nominal Length	Type	Approx. Pkd. Wt.	i		4	
			(lbs.)	(kg)	Cat. No.	Cat. No.
18 457	Side	0.5 0.2	MXLS18-4P		MAX4-LS18-4P	
24 610	Side	0.5 0.2	MXLS24-4P		MAX4-LS24-4P	
24 610	Back	0.5 0.2	MXL24-4P		MAX4-L24-4P	
36 914	Back	1.00 0.4	MXL36-4P		MAX4-L36-4P	
48 1219	Back	1.25 0.6	MXL48-4P		MAX4-L48-4P	
60 1524	Back	1.75 0.8	MXL60-4P		MAX4-L60-4P	

Note: Not suitable for cart-wash applications.



METROMAX® ACCESSORIES



Contain it

Efficiently enclose and contain with Enclosure Panels.

Enclosure Panels — {9.25}

- An efficient way of enclosing the sides and back of all shelves in a unit to contain stored contents.
- Slot opening: 3" W x 3.87" H.
- Designed to work with MetroMax® i, MetroMax® 4, and MetroMax® Q shelves. Mounting clips included.

Use shelf to shelf dividers with enclosure panels to create full height compartments to organize bulky, hard-to-handle supplies.

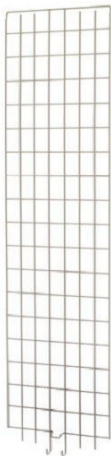

Enclosure Panel

Actual Width/Height (in.)	Actual Width/Height (mm)	Post Height (in.)	Post Height (mm)	For use with		Shelf Width (in.)	Shelf Width (mm)	Approx. Pkd. Wt.		i, 4, and Q Cat. No.
				(in.)	(mm)			(lbs.)	(kg)	
12.37 x 51.25	315 x 1300	54	1370	18		18	457	6.25	2.8	MEP35E
12.37 x 59.25	315 x 1505	63	1600	18		18	457	7	3.2	MEP36E
12.37 x 71.25	315 x 1810	74	1880	18		18	457	8.75	4.0	MEP37E
18.37 x 51.25	467 x 1300	54	1370	21, 24		21, 24	530, 610	9	4.1	MEP55E
18.37 x 59.25	467 x 1505	63	1600	21, 24		21, 24	530, 610	10.25	4.7	MEP56E
18.37 x 71.25	467 x 1810	74	1880	21, 24		21, 24	530, 610	11.75	5.3	MEP57E

*Note: Can be retrofitted to original MetroMax and MetroMax Q shelving.

Panels Required to Enclose Both Ends of the Shelving Unit or Cart

Post Height	Shelf Width		
	14 1/8" (355mm/457mm)	21" (530mm)	28" (610mm)
54" (1370mm)	(2) MEP35E	(2) MEP55E	(2) MEP55E
63" (1600mm)	(2) MEP36E	(2) MEP56E	(2) MEP56E
74" (1880mm)	(2) MEP37E	(2) MEP57E	(2) MEP57E

Configuration Notes

1. Handles and enclosure panels can be used on the same end of the cart. Please note the following details: 21" (530mm) wide units: use the 12.37" (315mm) wide panel on the same end as the handle.
2. Top-Track: When using on the ends of a Top-Track mobile unit the enclosure panel must be mounted so that it does not interfere with the overhead tracks. Mobile posts on Top-Track are 74" (1880mm). The standard panels for a 63" post are recommended.

Panels Required to Enclose Back of Shelving Unit or Cart

Post Height	Shelf Length						
	30" (760mm)	36" (914mm)	42" (1066mm)	48" (1219mm)	54" (1370mm)	60" (1524mm)	72" (1825mm)
54" (1370mm)	(2) MEP35E	(1) MEP35E (1) MEP55E	(2) MEP55E	(2) MEP35E (1) MEP55E	(1) MEP35E (2) MEP55E	(3) MEP55E	(1) MEP35E (3) MEP55E
63" (1600mm)	(2) MEP36E	(1) MEP36E (1) MEP56E	(2) MEP56E	(2) MEP36E (1) MEP56E	(1) MEP36E (2) MEP56E	(3) MEP56E	(1) MEP36E (3) MEP56E
74" (1880mm)	(2) MEP37E	(1) MEP37E (1) MEP57E	(2) MEP57E	(2) MEP37E (1) MEP57E	(1) MEP37E (2) MEP57E	(3) MEP57E	(1) MEP37E (3) MEP57E



MetroMax® i Mounting Clip Replacements

Bag of 8
Cat. No. RPMX3-RODTAB

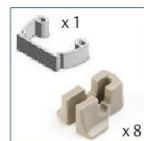

MetroMax® Q Mounting and Bottom Adapter Clip Replacements

Bag of 8
Cat. No. RPMQ3-RODTAB



MetroMax® 4 Mounting Clip Replacements

Bag of 8
Cat. No. RPMX4-RODTAB



METROMAX® ACCESSORIES

Find it.

Label Holders

- Plastic holders snap onto shelf edge to accommodate 1" (25mm) tall adhesive label. Label not included.
- i, 4, and Q versions available.
- Optional label holder covers exist for MetroMax Q models. Cover snaps onto the label holder to hold a non-adhesive label in place or to protect any label from dirt and moisture.



MetroMax® i Label Holder — {9.25}

Designed to accept label cards or adhesive labels. Slot measures approximately 1.25" (32mm).

Actual Length (in.)	Actual Length (mm)	Fits Shelf Length (in.) (mm)		Approx. Pkd. Wt. (lbs.) (kg)		Cat. No.
4.50	114	All		.03	.01	9989PX
11.28	285	24	610	.14	.06	9989X1
23.28	590	36	914	.30	.13	9989X3
35.28	895	48	1219	.40	.18	9989X5



MetroMax® i Label Holder

MetroMax® Q Label Holder — {9.25}

Designed to accept label cards or adhesive labels. Slot measures approximately 1.25" (32mm).

Actual Length (in.)	Actual Length (mm)	Fits Shelf Length (in.) (mm)		Approx. Pkd. Wt. (lbs.) (kg)		Cat. No.
4	102	All		.03	.01	MQ04LH
15.44	392	24	610	.14	.06	MQ24LH
27.44	697	36	914	.30	.13	MQ36LH
39.44	1002	48	1219	.40	.18	MQ48LH
51.44	1307	60	1524	.50	.22	MQ60LH
63.44	1611	72	1825	.60	.27	MQ72LH



MetroMax® Q Label Holder

MetroMax® 4 Label Holder — {9.25}

Designed to accept label cards or adhesive labels. Slot measures approximately 1" (25mm).

Actual Length (in.)	Actual Length (mm)	Fits Shelf (in.)	Fits Shelf (mm)	Approx. Pkd. Wt. (lbs.) (kg)		Cat. No.
4	102	All	All	.03	.01	MAX4-9989PX



MetroMax® 4 Label Holder

Color Shelf Markers — {9.25}

- Attach easily to shelf for content identification.
- Use to assign color coding to individual shelf levels, shelving units, carts, or storage areas.
- i and Q versions available.
- 6" (152mm) length.



MetroMax® i Color Shelf Marker

Shelf Marker Color	Approx. Pkd. Wt.		i		Q	
	(lbs.)	(kg)	Cat. No.	Cat. No.	Cat. No.	Cat. No.
Blue	0.05	0.02	CSM6-BX	CSM6-BQ		
Green	0.05	0.02	CSM6-GX	CSM6-GQ		
Red	0.05	0.02	CSM6-RX	CSM6-RQ		
Tan	0.05	0.02	CSM6-TX	CSM6-TQ		
White	0.05	0.02	CSM6-WX	CSM6-WQ		
Yellow	0.05	0.02	CSM6-YX	CSM6-YQ		
Gray	0.05	0.02	CSM6-GRX	CSM6-GRQ		

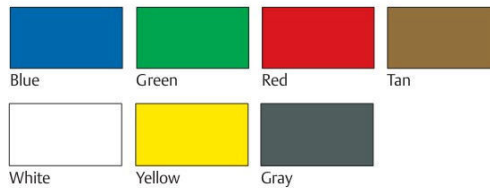

METROMAX® ACCESSORIES



Totes sold separately

Super Slide — {9.25}

- Designed to fit a 24" (610mm) wide shelf.
- Easily attaches to the shelf frame (under the mats) and is sized to hold 3", 5", 6", and 8" (76, 127, 152, 203mm) tall tote boxes (sold separately).
- MetroMax® i and MetroMax 4 models available.
- Corrosion resistant taupe epoxy finish with Microban antimicrobial product protection.

Width (mm)		Length (mm)		Height (mm)		Approx. Pkd. Wt. (lbs./kg)		i Cat. No.	4 Cat. No.
20.4	520	21.6	550	10.3	260	5.3	2	MXSS2E	MAX4-SS2E



Adjustable Slides — {9.25}

- Slides can be adjusted left to right to accommodate a variety of pan, tray, and container sizes.
- MetroMax® i and Q models available.
- Corrosion resistant taupe epoxy finish with Microban antimicrobial product protection.
- Shelves must be spaced 20" (508mm) apart.
- Can be used in conjunction with 20" (508mm) tall shelf-to-shelf dividers.

Fits Shelf Width (mm)		Type	Approx. Pkd. Wt. (lbs./kg)		i Cat. No.	Q Cat. No.
24	610	Adjustable	12.75	6	MX24SE	MQ24SE



Can Rack System — {9.25}

- Front loading, front dispensing can rack holds eight #10 cans or twelve #5 cans.
- Tough, corrosion resistant taupe epoxy finish with Microban antimicrobial product protection.
- Designed to fit a 24" (610mm) wide shelf.
- Mounts on any MetroMax® i or MetroMax Q shelf.

Width/Length/Height (mm)		Approx. Pkd. Wt. (lbs./kg)		i and Q Cat. No.
7.87x25.31x15	200x643x381	10	4.5	CR24E



METROMAX® ACCESSORIES

Storage Level Frames — {9.25}

- Open four-sided frames accommodate drop-in accessories including wire baskets and stainless drying racks.
- Includes corrosion proof MetroMax i frame and a bag of wedges.
- Can be mounted on MetroMax i, MetroMax 4, and MetroMax Q shelving units.

Width (in.)	Nominal Exterior Length		Frame Interior Width/Length		Approx. Pkd. Wt.		Cat. No.	
	(mm)	(in.)	(mm)	(in.)	(lbs.)	(kg)		
18	457	36	914	18x32	457x810	7	3.2	M4F1836
24	610	24	610	24x20	610x510	7.5	3.4	M4F2424
24	610	36	914	24x32	610x810	11.25	5.1	M4F2436
24	610	42	1060	24x38	610x965	13.25	6.0	M4F2442
24	610	48	1220	24x44	610x1120	15	6.8	M4F2448
24	610	60	1524	24x56	610x1370	18.75	8.5	M4F2460

Note: Any MetroMax i shelf can be converted to an open storage level frame. Simply remove the shelf mats and center beam to create an open frame.



MetroMax i Configuration

QTY. to fill out shelf frame.

FRAME	MB2416XE	MB2422XE
M4F2436	2	
M4F2442	1	1
M4F2448		2
M4F2460	2	1

MetroMax 4 Configuration

SHELF	MB2416XE	MB2422XE
MAX4-2436G		1
MAX4-2442G	2	
MAX4-2448G	1	1
MAX4-2460G	3	

NOTE: Remove the shelf mats to install the drop in basket.

Wire Baskets — {9.25}

- Conveniently hold small items.
- 9" (229mm) deep with built in storage handles allow easy removal.
- Installs flat. Mount to a MetroMax i storage level frame. Retrofits to a MetroMax i shelf or MetroMax 4 shelf.
- Corrosion resistant taupe epoxy finish with a weight capacity of 50 lbs. (23kg)



NOTE: Wire baskets can be retrofitted to MetroMax i or MetroMax 4 shelves.

MetroMax i: Remove the mats & center beams and drop in the baskets.

MetroMax 4: Remove the mats and drop in the baskets.

Wire baskets can fit a MetroMax 4 shelf. Left to right the baskets will not exactly fill the space. Use a MetroMax i frame for perfect fit.

Nominal Width	Length		Cat. No.
	(in.)	(mm)	
14x16	610x406	MB2416XE	
24x22	610x610	MB2422XE	



Glassware Handling Basket

Vinyl coated. Fits 18 x 36" (457 x 914mm) MetroMax i frame.

Cat. No. **GWBSKT36**
See Spec Sheet 52.01 for detail.
Not NSF listed.

3-Sided frames

- 1" (25mm) x 1.5" (38mm) structural steel tubing. Includes tri-lobal adapters to attach to posts. (Replacement adapters: Cat. No. MTLA bag of 4)
- Corrosion resistant epoxy finish.
- Use when configuring work tables or as a 3-sided ledge to contain bulky items.

Nominal Width	Length		Cat. No. i, 4, Q
	(in.)	(mm)	
18x60	355x1524	M3TF1860E	
24x24	610x610	M3TF2424E	
24x30	610x760	M3TF2430E	
24x36	610x914	M3TF2436E	
24x42	610x1066	M3TF2442E	
24x48	610x1219	M3TF2448E	
24x54	610x1370	M3TF2454E	
24x60	610x1524	M3TF2460E	

3-sided frame



METROMAX® DRYING RACKS



LEARN MORE

Take drying to the max.



PR36VX2-XDR

Consists of (3) shelf frames, (4) 63" (1600mm) mobile posts, (4) corrosion resistant polymer casters (two swivel, two brake), (3) tray racks, and (1) drip tray.



MetroMax i Drying Rack — {9.31}



Drip Tray Mobile Drying Rack Units

Combine the corrosion protection and strength of MetroMax i with the convenience of a drying rack unit that efficiently sorts and holds items while they dry to prevent wet nesting.

Three Tray Racks (three tier unit)

Model No.	Nominal Width (in.) (mm)	Nominal Length (in.) (mm)	Nominal Height (in.) (mm)
PR36VX2-XDR	24 610	36 914	68 1702
PR48VX2-XDR	24 610	48 1219	68 1702



Two SS Drop-ins, One Tray Rack, One Bulk Shelf (4-tier)

Model No.	Nominal Width (in.) (mm)	Nominal Length (in.) (mm)	Nominal Height (in.) (mm)
PR36VX3-XDR	24 610	36 914	68 1702
PR48VX3-XDR	24 610	48 1219	68 1702

PR36VX3-XDR

Consists of (3) shelf frames, (1) shelf, (4) 63" (1600mm) posts, (4) corrosion resistant polymer casters (two swivel, two brake), (2) stainless steel drop-in racks, (1) tray rack (1) drip tray.



Open-Air Design

Wet floors can be hazardous to employees. Minimize water on the floor from dripping items by containing and funneling water into a standard steam pan (not included).



PLAY VIDEO



Two Tray Racks and Two Pan Racks (4-tier)

Model No.	Nominal Width (in.) (mm)	Nominal Length (in.) (mm)	Nominal Height (in.) (mm)
PR36VX4-XDR	24 610	36 914	68 1702
PR48VX4-XDR	24 610	48 1219	68 1702

Note: For the actual dimensions for mobile units, add 2" (51mm) to the nominal dimension to account for the bumpers.



PR36VX4-XDR

Consists of (4) shelf frames, (4) 63" (1600mm) posts, (4) corrosion resistant polymer casters (two swivel, two brake), (2) tray racks, (2) steam pan racks, (1) drip tray.



METROMAX® DRYING RACKS

MetroMax i Drying Rack — {9.31}



Drying Racks Units without drip trays

Mobile Model No.	Nominal Width (in.) (mm)	Nominal Length (in.) (mm)	Nominal Height (in.) (mm)
PR48VX3	24 610	48 1219	68 1702
PR48VX4	24 610	48 1219	68 1702

Stationary Model No.	Nominal Width (in.) (mm)	Nominal Length (in.) (mm)	Nominal Height (in.) (mm)
PR48X3	24 610	48 1219	74 1880
PR48X4	24 610	48 1219	74 1880

Note: For the actual dimensions for mobile units, add 2" (51mm) to the nominal dimension to account for the bumpers.



MOST POPULAR

PR48VX3

Consists of (2) shelf frames, (2) shelves, (4) 63" (1600mm) posts, (4) corrosion resistant polymer casters (two swivel, two brake), (1) tray rack, and (2) stainless steel drop-ins.



SHELVING ASSEMBLY



MAX4-PR36VX2

Consists of (3) shelf frames, (4) 63" (1600mm) mobile posts, (4) corrosion resistant polymer casters (two swivel, two brake), (3) tray racks.

MetroMax 4 Drying Rack — {9.32}



Mobile Drying Rack Units

Combine the corrosion protection and strength of MetroMax i with the convenience of a drying rack unit that efficiently sorts and holds items while they dry to prevent wet nesting.

Three Tray Racks (three tier unit)

Model No.	Nominal Width (in.) (mm)	Nominal Length (in.) (mm)	Nominal Height (in.) (mm)
MAX4-PR36VX2	24 610	36 914	68 1702
MAX4-PR48VX2	24 610	48 1219	68 1702



MAX4-PR36VX3

Consists of (3) shelf frames, (1) Bottom shelf with removable mats, (4) 63" (1600mm) mobile posts, (4) corrosion resistant polymer casters (two swivel, two brake), (1) tray rack, and (2) stainless steel drop-in racks.

Two SS Drop-ins, One Tray Rack, One Bulk Shelf (4-tier)

Model No.	Nominal Width (in.) (mm)	Nominal Length (in.) (mm)	Nominal Height (in.) (mm)
MAX4-PR36VX3	24 610	36 914	68 1702
MAX4-PR48VX3	24 610	48 1219	68 1702



MAX4-PR36VX4

Consists of (4) shelf frames, (4) 63" (1600mm) mobile posts, (4) corrosion resistant polymer casters (two swivel, two brake), (2) tray racks, and (2) pan racks.

Two Tray Racks and Two Pan Racks (4-tier)

Model No.	Nominal Width (in.) (mm)	Nominal Length (in.) (mm)	Nominal Height (in.) (mm)
MAX4-PR36VX4	24 610	36 914	68 1702
MAX4-PR48VX4	24 610	48 1219	68 1702

Note: For the actual dimensions for mobile units, add 2" (51mm) to the nominal dimension to account for the bumpers.

METROMAX® DRYING RACKS



Drying Rack Accessories

- Use to create a unique configuration to fit the application. These may be added to existing shelves or shelf frames when a specific configuration or single drying/ sorting tier is needed.

Cutting Board & Tray Drying Rack Accessories

- Mount to open grid and solid MetroMax i shelves, MetroMax i open shelf frames, MetroMax 4 open shelf frames, MetroMax Q, Super Erecta Pro, and Super Erecta.
- For best air circulation use with an open shelf frame.
- 1.12" (28mm) or 3" (76mm) slot spacing available.
- Polymer glide strips provide an impact resistant surface for long life.

Model No.	Fits Shelf or Frame (in./mm)		Upright Spacing (in./mm)		Upright Height (in./mm)		Tray Capacity	Approx. Pkd. Wt. (lbs./kg)	
XTR2436XE	24x36	610x914	1.12	28	6	150	24	14.7	6.7
XTR2448XE	24x48	610x1219	1.12	28	6	150	34	19.8	9.0
XTR2460XE	24x60	610x1524	1.12	28	6	150	43	25.4	11.5
XTR2436XEA	24x36	610x914	3	76	6	150	10	9.9	4.5
XTR2448XEA	24x48	610x1219	3	76	6	150	14	12.9	5.8
XTR2460XEA	24x60	610x1524	3	76	6	150	17	16.4	7.4

Note: Can be retrofitted to older Metro shelving systems.

Actual Width and Length: Add 7/8" (22mm) to nominal width. Add 1/2" (13mm) to nominal length.

Type 304 Stainless Drop-In Racks (for MetroMax i only)

- Drop-ins require a four-sided MetroMax i frame. See spec sheet 9.25
- Center beams are optional and may be added for additional load capacity.
- A drop-in rack can be added to a standard MetroMax i shelf by removing the shelf mats and using the shelf frame. The center beam is optional.

Model No.	Fits Shelf or Frame (in./mm)		Actual Length (in./mm)		Actual Height (in./mm)		Approx. Pkd. Wt. (lbs./kg)	
DR36S	24x36	610x914	33.87	860	5.25	133	6.5	2.9
DR48S	24x48	610x1219	45.87	1165	5.25	133	8.5	3.9
DR60S	24x60	610x1524	57.87	1470	5.25	133	11	5

Actual Width: Add 3/4" (19mm) to nominal width.

Drip Tray - Patent pending water collection system.

- Must be mounted to a **MetroMax i** shelf frame or shelf - Drip Tray assembly adjusts to fit 24x36" and 24x48" (610x914 or 610x1219mm) sizes.
- Consists of (2) solid polymer chutes and (1) mounting frame.
- Collection pan is not included. The mounting frame is designed to hold a full size steam pan or GN 1/1, preferably 2.5" or 4" tall (64 or 102mm).
- Materials
Solid Chute: HDPE
Mounting Frame: Aluminum
- Model No.: **XDRIP**



XDRIP



Mounted to 24x36" (610x914mm) Frame. Steam Pan not included.



XTR2436XE

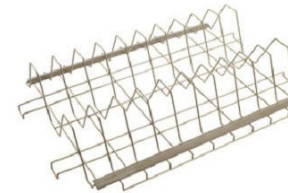

XTR2436XEA

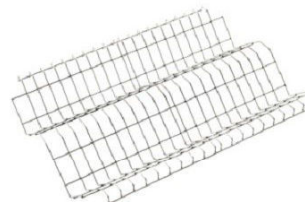

DR36S

Tip: Mount tray and pan racks on an open frame over the drip tray for maximum water collection.



Mounted to 24x48" (610x1219mm) Open Frame with Tray Rack. Steam Pan not included.



METROMAX® DRYING RACKS

Sorting Pegs and Hanging Accessories

6" Tall (152mm) Sorting Pegs

- Installs to any open grid polymer Metro shelf
- Pack of 8 Pegs
- Can be used to manage steam pans 4" (102mm) and deeper
- Material: Mineral reinforced polypropylene
- Model No. **X6PEG-8PK**

X6PEG-8PK

X8



Drying Option.

Tray and pan drying wire racks are compatible with any Super Erecta, Super Erecta Pro, or Super Adjustable Super Erecta Shelf.



XTR2436XE

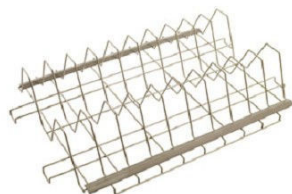

XTR2436XEA



XTR2436XE Shown on a SmartWall unit atop of Super Erecta Shelving in Metroseal Gray.

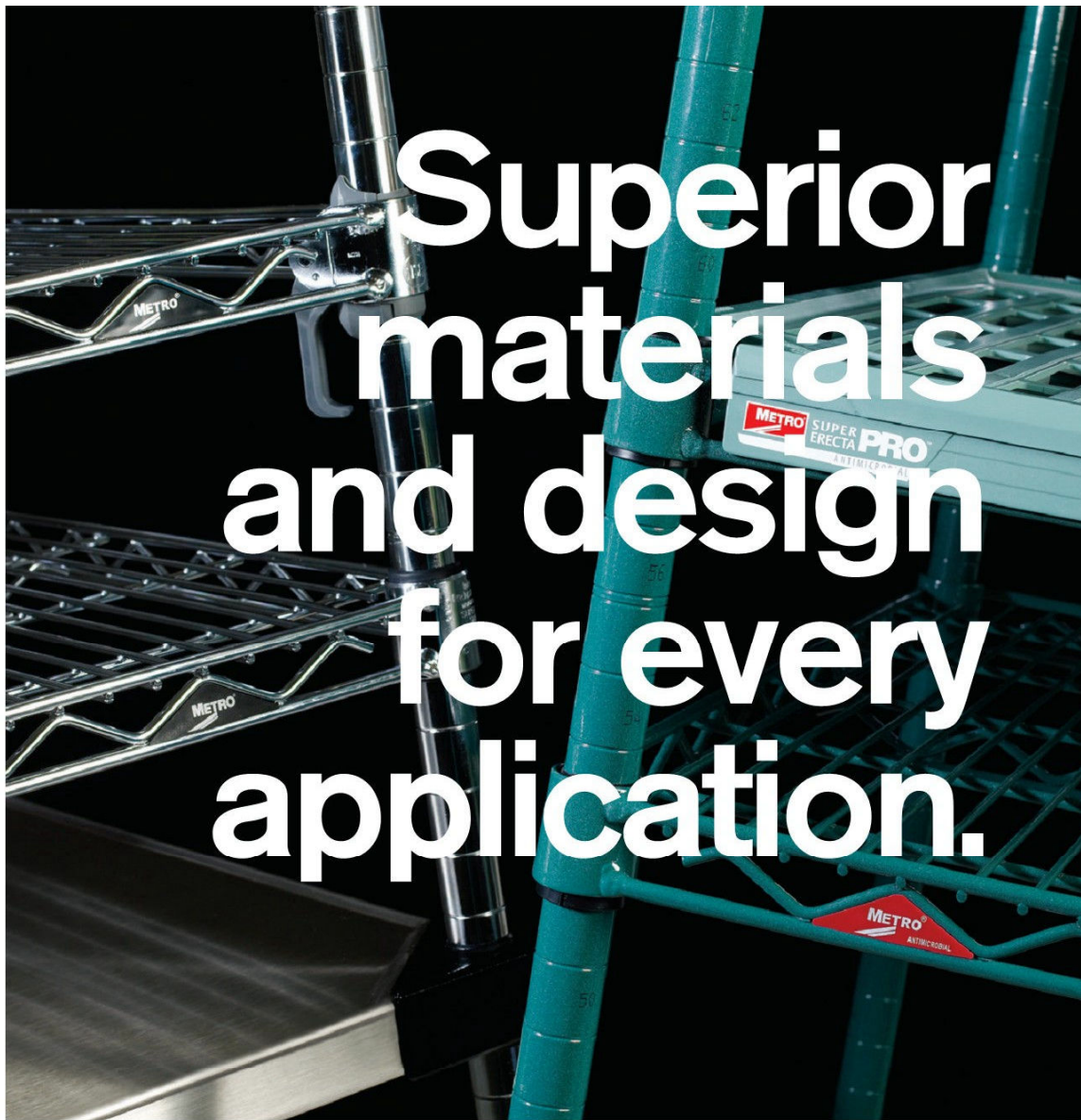



Super Erecta Pro®
 Super Adjustable Super Erecta®
 and Super Erecta®
 Erecta Shelf®
 HD Super™
 qwikSLOT®
 qwikSIGHT™

WIRE & SOLID SHELVING SOLUTIONS

Wire and Solid Shelving Solutions34-93

Wire/Polymer Hybrid Shelving.....36-39

Easy-Adjust Shelving & Carts.....40-45

Wire Shelving, Carts & Trucks.....46-56

Casters for Wire Shelving.....58-59

Dollies & Plate Casters.....60-62

Accessories for Wire Shelving.....63-73

Solid Shelving & Accessories.....74-76

Light-Duty Wire Shelving & Accessories.....77

Heavy-Duty Solid Shelving & Accessories.....78-79

qwikSLOT Adjustable Shelving.....80-83

Basket Shelving & Accessories.....84-89

Storage Bins & Totes.....90-93

SUPER ERECTA PRO® SHELVING



LEARN MORE

Epoxy-coated Super Erecta-style frames with removable polymer shelf mats.

Stays cleaner between cleanings.

Polymer shelf mats and Metroseal Green epoxy-coated shelf frames and posts have built in Microban® antimicrobial product protection.



Super Erecta Pro®
Durable & cleanable.
The original — reinnovated.

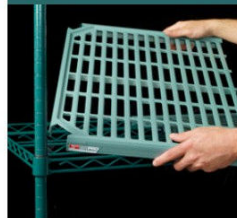

Easy to clean.

Lift-off mats can be easily removed and washed by hand or in a wash machine.

Prolonged durability.

Polymer shelf mats withstand daily abuse from containers and sharp edges. Robust design provides the strength and rigidity of Super Erecta...holds up to 800 lbs. (363kg) per shelf.



Interchangeable.

Super Erecta Pro shelves can be configured with traditional shelf and accessory options on the same unit for maximum flexibility.



SUPER ERECTA PRO® SHELVING



Super Erecta® Pro Shelves — {10.80}

Shelves are priced individually and packaged no more than 4 per carton except 60" (1524mm) and 72" (1829mm) lengths which are packaged no more than 2 per carton. Plastic split sleeves are included with each shelf.



SHELVING ASSEMBLY

Nominal Width/Length (in.) (mm)	Cat. No. Super Erecta Pro Metroseal Green	Nominal Width/Length (in.) (mm)	Cat. No. Super Erecta Pro Metroseal Green		
14x24	355x610	PR1424NK3	21x24	530x610	PR2124NK3
14x30	355x760	PR1430NK3	21x30	530x760	PR2130NK3
14x36	355x914	PR1436NK3	21x36	530x914	PR2136NK3
14x42	355x1060	PR1442NK3	21x42	530x1060	PR2142NK3
14x48	355x1219	PR1448NK3	21x48	530x1219	PR2148NK3
14x54	530x1372	-	21x54	530x1372	PR2154NK3
14x60	355x1524	PR1460NK3	21x60	530x1524	PR2160NK3
14x72	355x1829	PR1472NK3	21x72	530x1829	PR2172NK3
18x24	457x610	PR1824NK3	24x24	610x610	PR2424NK3
18x30	457x760	PR1830NK3	24x30	610x760	PR2430NK3
18x36	457x914	PR1836NK3	24x36	610x914	PR2436NK3
18x42	457x1060	PR1842NK3	24x42	610x1060	PR2442NK3
18x48	457x1219	PR1848NK3	24x48	610x1219	PR2448NK3
18x54	457x1372	PR1854NK3	24x54	610x1372	PR2454NK3
18x60	457x1524	PR1860NK3	24x60	610x1524	PR2460NK3
18x72	457x1829	PR1872NK3	24x72	610x1829	PR2472NK3

Note: Each Super Erecta Pro™ shelf up to and including 48" (1219mm) long have a maximum weight capacity of 800 lbs. (363kg) evenly distributed. Shelves longer than 48" (1219mm) have a maximum weight capacity of 600 lbs. (272kg) evenly distributed.

Actual Dimensions: Width: Add .25" (6mm) to nominal size. Length: Subtract .25" (6mm) from nominal size.

SHELVING HEIGHT GUIDELINES

Shelf Depth	14" (356mm)	18" (457mm)	21" (533mm)	24" (610mm)
Maximum Allowable Post Height				
Stationary	63" (1600mm)	86" (2184mm)	86" (2184mm)	96" (2438mm)

Note: For stationary units with foot plates or wall brackets properly attached to the floor or wall, the maximum allowable height is 96" (2438mm).

SiteSelect® Posts — {10.80}

Stationary Super Erecta SiteSelect posts are fitted with adjustable leveling bolts to compensate for uneven surfaces. Mobile posts come without leveling bolt assembly to accommodate stem casters. Special length posts are available. See page 58-59 for stem caster options.

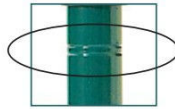

Posts provide a visual guide for positioning and adjusting shelves with an easy-to-identify double groove, every 8" (203mm).



Super Erecta® Pro Easy Order Kits

Kit includes four shelves and four 74.5" (1892mm) split posts. Ships in one box.

Stationary Posts

Height (in.)	Height (mm)	Cat. No. Metroseal 3	Cat. No. Stainless
14.37	370	13PK3	13PS
34.37	875	33PK3	33PS
54.44	1385	54PK3	54PS
62.44	1590	63PK3	63PS
74.5	1895	74PK3	74PS
86.5	2200	86PK3	86PS

Note: Height includes post cap and leveling bolt (Completely tightened).

Mobile Posts

Height (in.)	Height (mm)	Cat. No. Metroseal 3	Cat. No. Stainless
13.75	349	13UPK3	13UPS
33.75	857	33UPK3	33UPS
53.81	1366	54UPK3	54UPS
61.81	1570	63UPK3	63UPS
69.75	1772	70UPK3	—
73.87	1876	74UPK3	74UPS
85.87	2181	86UPK3	86UPS

Nominal Width/Length (in.) (mm)	Approx. Pkd. Wt. (lbs.) (kg)	Cat. No. Super Erecta Pro Metroseal 3
18x36 (457x914)	58 26.3	EZPR1836NK3-4
18x48 (457x1219)	73 33.1	EZPR1848NK3-4
24x36 (610x914)	72 32.6	EZPR2436NK3-4
24x48 (610x1219)	83 37.6	EZPR2448NK3-4

☑ Indicates antimicrobial product.

1.800.992.1776 • WWW.METRO.COM

37

SUPER ERECTA PRO® SHELVING



Shelving Starter and Add-On Units — {10.82}

- Starter Units consist of four posts and indicated number of Super Erecta Pro shelves.
- Add-On Units consist of two posts, indicated number of shelves, and two "S" Hooks per shelf, for attaching shelf to adjacent unit.

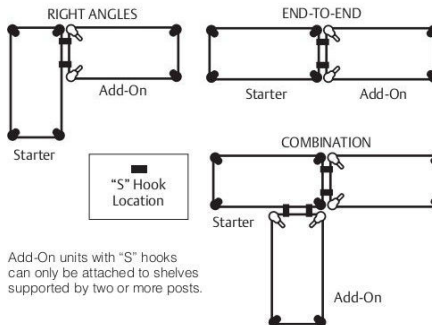

4 Shelf Super Erecta Pro Unit with 63" Posts

4 Shelf Super Erecta Pro Unit with 74" Posts

Nominal Width/Length (in.)	Nominal Width/Length (mm)	Cat. No. Starter Unit	Cat. No. Add-On Unit	Cat. No. Starter Unit	Cat. No. Add-On Unit
18x24	457x610	PR-182463K3-S-4	PR-182463K3-A-4	PR-182474K3-S-4	PR-182474K3-A-4
18x30	457x760	PR-183063K3-S-4	PR-183063K3-A-4	PR-183074K3-S-4	PR-183074K3-A-4
18x36	457x914	PR-183663K3-S-4	PR-183663K3-A-4	PR-183674K3-S-4	PR-183674K3-A-4
18x42	457x1060	PR-184263K3-S-4	PR-184263K3-A-4	PR-184274K3-S-4	PR-184274K3-A-4
18x48	457x1219	PR-184863K3-S-4	PR-184863K3-A-4	PR-184874K3-S-4	PR-184874K3-A-4
18x54	457x1372	PR-185463K3-S-4	PR-185463K3-A-4	PR-185474K3-S-4	PR-185474K3-A-4
18x60	457x1524	PR-186063K3-S-4	PR-186063K3-A-4	PR-186074K3-S-4	PR-186074K3-A-4
18x72	457x1829	PR-187263K3-S-4	PR-187263K3-A-4	PR-187274K3-S-4	PR-187274K3-A-4
21x24	530x610	PR-212463K3-S-4	PR-212463K3-A-4	PR-212474K3-S-4	PR-212474K3-A-4
21x30	530x760	PR-213063K3-S-4	PR-213063K3-A-4	PR-213074K3-S-4	PR-213074K3-A-4
21x36	530x914	PR-213663K3-S-4	PR-213663K3-A-4	PR-213674K3-S-4	PR-213674K3-A-4
21x42	530x1060	PR-214263K3-S-4	PR-214263K3-A-4	PR-214274K3-S-4	PR-214274K3-A-4
21x48	530x1219	PR-214863K3-S-4	PR-214863K3-A-4	PR-214874K3-S-4	PR-214874K3-A-4
21x54	530x1372	PR-215463K3-S-4	PR-215463K3-A-4	PR-215474K3-S-4	PR-215474K3-A-4
21x60	530x1524	PR-216063K3-S-4	PR-216063K3-A-4	PR-216074K3-S-4	PR-216074K3-A-4
21x72	530x1829	PR-217263K3-S-4	PR-217263K3-A-4	PR-217274K3-S-4	PR-217274K3-A-4
24x24	610x610	PR-242463K3-S-4	PR-242463K3-A-4	PR-242474K3-S-4	PR-242474K3-A-4
24x30	610x760	PR-243063K3-S-4	PR-243063K3-A-4	PR-243074K3-S-4	PR-243074K3-A-4
24x36	610x914	PR-243663K3-S-4	PR-243663K3-A-4	PR-243674K3-S-4	PR-243674K3-A-4
24x42	610x1060	PR-244263K3-S-4	PR-244263K3-A-4	PR-244274K3-S-4	PR-244274K3-A-4
24x48	610x1219	PR-244863K3-S-4	PR-244863K3-A-4	PR-244874K3-S-4	PR-244874K3-A-4
24x54	610x1372	PR-245463K3-S-4	PR-245463K3-A-4	PR-245474K3-S-4	PR-245474K3-A-4
24x60	610x1524	PR-246063K3-S-4	PR-246063K3-A-4	PR-246074K3-S-4	PR-246074K3-A-4
24x72	610x1829	PR-247263K3-S-4	PR-247263K3-A-4	PR-247274K3-S-4	PR-247274K3-A-4

For additional wire shelves, order from page 37.

Starter Unit



Add-On Unit



8x Add-On Units ship with (8) "S" Hooks



"S" Hooks

Eliminates the need for adjacent posts. Two required for each storage level. Cat. No. Q9995Z

Can be used to configure end-to-end and right angle (corner) add-on units.



SUPER ERECTA PRO® SHELVING

Accessories — {10.81}

8" Polymer Divider

- Corrosion proof

Nominal Length (in.)	(mm)	Standard Duty Cat. No.	Light Duty Cat. No.
18	457	MQD18-8	MUD18-8
24	610	MQD24-8	MUD24-8

Note: MUD18-8 Divider fits 21" deep shelf.



Standard Duty



Light Duty

Tall Shelf-to-Shelf Divider

- Connects between two shelves
- Corrosion proof

Nominal Height (in.)	(mm)	Compatible with Shelf Depths (in.) (mm)		Cat. No.
16	406	18, 21	457, 530	MD18-16
20	508	18, 21	457, 530	MD18-20
24	610	18, 21	457, 530	MD18-24
16	406	24	610	MD24-16
20	508	24	610	MD24-20
24	610	24	610	MD24-24



Shelf Ledges

- Corrosion proof, 2" (51mm) stackable shelf ledges.



Nominal Length (in.)	(mm)	Cat. No.
18	457	PRL18-2S
21	530	PRL21-2S
24	610	PRL24-2S
36	914	PRL36-2S
42	1060	PRL42-2S
48	1219	PRL48-2S
60	1524	PRL60-2S
72	1829	PRL72-2S



SB ShelfBuilder

The easiest way to build Shelving.

Color Shelf Marker

- 6" (152mm) Length
- Fits Super Erecta Pro Shelf
- Attach easily to shelf to identify contents stored.



Color	Length (in.) (mm)		Cat. No.
Blue	6	152	CSM6-BQ
Green	6	152	CSM6-GQ
Red	6	152	CSM6-RQ
Tan	6	152	CSM6-TQ
White	6	152	CSM6-WQ
Yellow	6	152	CSM6-YQ
Gray	6	152	CSM6-GRQ



Label Holders

- Fits Super Erecta Pro Shelf
 - Plastic holders snap into place to accommodate 1" (25mm) tall adhesive label.
- Cat. No. **MQ04LH**

☑ Indicates antimicrobial product.

1.800.992.1776 • WWW.METRO.COM

SUPER ADJUSTABLE SUPER ERECTA® SHELVING



Reclaim Wasted Space.



Super Adjustable Super Erecta® Shelving

Adjust and add shelves quickly and easily to reclaim wasted space.



Super Erecta

Easy "no-tool" shelf adjustment

1" (25mm) spacing minimizes dead space

Efficient use of space allows more storage levels to be added.

Storage efficiency can increase by 25% or more



Super Adjustable Super Erecta





SUPER ADJUSTABLE SUPER ERECTA® SHELVING

Available Finishes

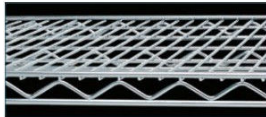

Type 304 Polished Stainless Steel
Addresses the most aggressive applications and environments. All-stainless solid and wire options exist for high temperature automated cart wash and autoclave applications.



Metroseal Green Epoxy
Corrosion resistant finish for wet or high humidity environments with a 12 year warranty against rust and corrosion. Microban antimicrobial is built into the finish to keep the product "cleaner between cleanings."



Chrome Plating
The "real" nickel-chrome finish for dry, low humidity environments. Metro's durable chrome finish includes a protective lacquer coat.



Available Posts

Standard Stationary Post with adjustable leveling foot. Stainless models also feature a stainless leveling foot. Use Foot Plates for greater stability.

Standard Mobile-Ready Posts accept Metro stem casters. Use these for the majority of standard duty transport and movable storage applications.

Cart Wash and Autoclave Applications
Swaged stainless post has a fastened aluminum post cap and is specifically designed to withstand high temperatures. See page 59 for part numbers.

Heavy Duty Transport
Staked post attaches to a dolly truck to address abusive transport applications. The reinforced connection between the base receptacle and post provides a more secure connection to the dolly truck. See page 60 for part numbers.



SUPER ADJUSTABLE SUPER ERECTA® SHELVING



Super Adjustable Super Erecta Wire Shelves — {10.01a} {10.10a}

Packaging: Wire shelves are priced individually and packaged no more than 4 per carton except 60" (1524mm) and 72" (1829mm) lengths and 30" (760mm) and 36" (914mm) widths, which are packaged no more than 2 per carton. Plastic sleeves and wedges are included with each shelf.



The easiest way to build Shelving.

SiteSelect® Posts — {10.01a} {10.10a}

Stationary Super Erecta® SiteSelect posts are fitted with adjustable leveling bolts to compensate for uneven surfaces. Mobile posts come without leveling bolt assembly to accommodate stem casters. Special length posts are available.



Stationary Posts

Actual Height (in.)	Actual Height (mm)	Cat. No. Chrome	Cat. No. Metroseal Green	Cat. No. Stainless
7.37	191	7P	7PK3	7PS
14.37	370	13P	13PK3	13PS
28.37	699	27P	27PK3	27PS
34.37	875	33P	33PK3	33PS
54.44	1358	54P	54PK3	54PS
62.44	1590	63P	63PK3	63PS
74.5	1895	74P	74PK3	74PS
86.5	2200	86P	86PK3	86PS
96.5	2454	***96P	-	-

*Height includes cap and leveling bolt (Completely tightened).
 Stainless stationary post includes stainless leveling bolt.
 ***96P should not be used on units less than 24" (610mm) deep.
 Consult Metro Engineering for alternate recommendations.

Note: Special length posts are available, priced at next higher length plus a cutting charge.

Mobile Posts

Actual Height (in.)	Actual Height (mm)	Cat. No. Chrome	Cat. No. Metroseal Green	Cat. No. Stainless
13.75	370	13UP	13UPK3	13UPS
27.75	699	27UP	27UPK3	27UPS
33.75	875	33UP	33UPK3	33UPS
54.81	1358	54UP	54UPK3	54UPS
61.81	1590	63UP	63UPK3	63UPS
69.75	1895	-	70UPK3	-
73.87	2200	74UP	74UPK3	74UPS
85.87	2454	86UP	86UPK3	86UPS

These posts come without leveling bolt assembly to accommodate stem casters. Casters for mobile applications can be found on pages 58 & 59.

Indicates antimicrobial product.

Nominal Width/Length (in.)	Nominal Width/Length (mm)	Cat. No. Chrome	Cat. No. Metroseal Green	Cat. No. Stainless
14x24	355x610	A1424NC	A1424NK3	A1424NS
14x30	355x760	A1430NC	A1430NK3	A1430NS
14x36	355x914	A1436NC	A1436NK3	A1436NS
14x42	355x1060	A1442NC	A1442NK3	A1442NS
14x48	355x1219	A1448NC	A1448NK3	A1448NS
14x60	355x1524	A1460NC	A1460NK3	A1460NS
14x72	355x1829	A1472NC	A1472NK3	A1472NS
18x24	457x610	A1824NC	A1824NK3	A1824NS
18x30	457x760	A1830NC	A1830NK3	A1830NS
18x36	457x914	A1836NC	A1836NK3	A1836NS
18x42	457x1060	A1842NC	A1842NK3	A1842NS
18x48	457x1219	A1848NC	A1848NK3	A1848NS
18x54	457x1370	A1854NC	A1854NK3	A1854NS
18x60	457x1524	A1860NC	A1860NK3	A1860NS
18x72	457x1829	A1872NC	A1872NK3	A1872NS
21x24	530x610	A2124NC	A2124NK3	A2124NS
21x30	530x760	A2130NC	A2130NK3	A2130NS
21x36	530x914	A2136NC	A2136NK3	A2136NS
21x42	530x1060	A2142NC	A2142NK3	A2142NS
21x48	530x1219	A2148NC	A2148NK3	A2148NS
21x54	530x1370	A2154NC	A2154NK3	A2154NS
21x60	530x1524	A2160NC	A2160NK3	A2160NS
21x72	530x1829	A2172NC	A2172NK3	A2172NS
24x24	610x610	A2424NC	A2424NK3	A2424NS
24x30	610x760	A2430NC	A2430NK3	A2430NS
24x36	610x914	A2436NC	A2436NK3	A2436NS
24x42	610x1060	A2442NC	A2442NK3	A2442NS
24x48	610x1219	A2448NC	A2448NK3	A2448NS
24x54	610x1370	A2454NC	A2454NK3	A2454NS
24x60	610x1524	A2460NC	A2460NK3	A2460NS
24x72	610x1829	A2472NC	A2472NK3	A2472NS
30x36	760x914	A3036NC	-	-
30x48	760x1219	A3048NC	-	-
30x60	760x1524	A3060NC	-	-
30x72	760x1829	A3072NC	-	-
36x36	910x914	A3636NC	-	-
36x48	910x1219	A3648NC	-	-
36x60	910x1524	A3660NC	-	-
36x72	910x1829	A3672NC	-	-

Note: The actual length of the shelves is .12" (3.2mm) shorter than the nominal dimension shown. The actual depth of the shelves is .12" (3.2mm) greater than the nominal dimension shown. Wire shelves up to 48" (1219mm) long have a weight capacity of 800 lbs. (363kg). Shelves longer than 48" (1219mm) have a weight capacity of 600 lbs. (272kg) per shelf evenly distributed. 14" (355mm) deep shelving – Stationary units taller than 63" (1600mm) must be fastened to the floor or wall using Metro foot plates or wall brackets. On mobile units the maximum allowable post height is 54" (1370mm). Metroseal is not cart-washable.



SUPER ADJUSTABLE SUPER ERECTA® SHELVING



Shelving Starter and Add-On Units — {10.91}

- Starter Units consist of four posts and indicated number of Super Adjustable Super Erecta shelves.
- Add-On Units consist of two posts, indicated number of shelves, and two "S" Hooks per shelf, for attaching shelf to adjacent unit.

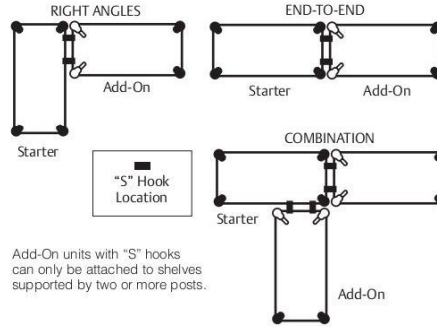

Nominal Width\Length (in.)\Length (mm)	4 Shelf Chrome Unit with 63" Posts		4 Shelf Chrome Unit with 74" Posts		5 Shelf Chrome Unit with 74" Posts		4 Shelf Metroseal Green Unit with 63" Posts		5 Shelf Metroseal Green Unit with 74" Posts	
	Cat. No. Starter Unit	Cat. No. Add-On Unit	Cat. No. Starter Unit	Cat. No. Add-On Unit	Cat. No. Starter Unit	Cat. No. Add-On Unit	Cat. No. Starter Unit	Cat. No. Add-On Unit	Cat. No. Starter Unit	Cat. No. Add-On Unit
18x24 457x610	A316C	AA316C	-	-	5A317C	5AA317C	A316K3	AA316K3	5A317K3	5AA317K3
18x30 457x760	A326C	AA326C	-	-	5A327C	5AA327C	A326K3	AA326K3	5A327K3	5AA327K3
18x36 457x914	A336C	AA336C	SA-183674C-S-4	-	5A337C	5AA337C	A336K3	AA336K3	5A337K3	5AA337K3
18x42 457x1060	A346C	AA346C	-	-	5A347C	5AA347C	A346K3	AA346K3	5A347K3	5AA347K3
18x48 457x1219	A356C	AA356C	SA-184874C-S-4	-	5A357C	5AA357C	A356K3	AA356K3	5A357K3	5AA357K3
18x60 457x1524	A366C	AA366C	SA-186074C-S-4	-	5A367C	5AA367C	A366K3	AA366K3	5A367K3	5AA367K3
18x72 457x1829	A376C	AA376C	SA-187274C-S-4	-	5A377C	5AA377C	A376K3	AA376K3	5A377K3	5AA377K3
21x24 530x610	A416C	AA416C	-	-	5A417C	5AA417C	A416K3	AA416K3	5A417K3	5AA417K3
21x30 530x760	A426C	AA426C	-	-	5A427C	5AA427C	A426K3	AA426K3	5A427K3	5AA427K3
21x36 530x914	A436C	AA436C	-	-	5A437C	5AA437C	A436K3	AA436K3	5A437K3	5AA437K3
21x42 530x1060	A446C	AA446C	-	-	5A447C	5AA447C	A446K3	AA446K3	5A447K3	5AA447K3
21x48 530x1219	A456C	AA456C	-	-	5A457C	5AA457C	A456K3	AA456K3	5A457K3	5AA457K3
21x60 530x1524	A466C	AA466C	-	-	5A467C	5AA467C	A466K3	AA466K3	5A467K3	5AA467K3
21x72 530x1829	A476C	AA476C	-	-	5A477C	5AA477C	A476K3	AA476K3	5A477K3	5AA477K3
24x24 610x610	A516C	AA516C	-	-	5A517C	5AA517C	A516K3	AA516K3	5A517K3	5AA517K3
24x30 610x760	A526C	AA526C	-	-	5A527C	5AA527C	A526K3	AA526K3	5A527K3	5AA527K3
24x36 610x914	A536C	AA536C	SA-243674C-S-4	-	5A537C	5AA537C	A536K3	AA536K3	5A537K3	5AA537K3
24x42 610x1060	A546C	AA546C	-	-	5A547C	5AA547C	A546K3	AA546K3	5A547K3	5AA547K3
24x48 610x1219	A556C	AA556C	SA-244874C-S-4	-	5A557C	5AA557C	A556K3	AA556K3	5A557K3	5AA557K3
24x60 610x1524	A566C	AA566C	SA-246074C-S-4	-	5A567C	5AA567C	A566K3	AA566K3	5A567K3	5AA567K3
24x72 610x1829	A576C	AA576C	SA-247274C-S-4	-	5A577C	5AA577C	A576K3	AA576K3	5A577K3	5AA577K3

For Super Adjustable Super Erecta, order from page 42.

✓ Indicates antimicrobial product.



Replacement "S" Hook

2 are required for each storage level.
Cat. No. 9995Z



Security "S" Hook

2 are required for each storage level.
Chrome. Cat. No. H9995C
Black. Cat. No. H9995B

SUPER ADJUSTABLE SUPER ERECTA® SHELVING CARTS



Super Adjustable Super Erecta® Stem Caster Carts — {11.01a}

5" (127mm) resilient rubber or polyurethane casters with donut bumpers.

Safely Hold up to
600 lbs.
per mobile unit.
*BC models with resilient rubber casters.

Safely Hold up to
900 lbs.
per mobile unit.
*EC models with polyurethane casters.



COMPLETE UNIT HEIGHT
67 7/8" (1724mm)

4-Shelf Mobile Chrome Unit with 63" Posts

Nominal Width/Length (in.)	Nominal Width/Length (mm)	Resilient Rubber Casters	Polyurethane Casters
		(2) Swivel, (2) Brake	(2) Swivel, (2) Brake
18x36	457x914	A336BC	A336EC
18x48	457x1219	A356BC	A356EC
18x60	457x1524	A366BC	A366EC
21x36	530x914	A436BC	A436EC
21x48	530x1219	A456BC	A456EC
21x60	530x1524	A466BC	A466EC
24x36	610x914	A536BC	A536EC
24x48	610x1219	A556BC	A556EC
24x60	610x1524	A566BC	A566EC

5-Shelf Mobile Chrome Unit with 63" Posts

Nominal Width/Length (in.)	Nominal Width/Length (mm)	Resilient Rubber Casters	Polyurethane Casters
		(2) Swivel, (2) Brake	(2) Swivel, (2) Brake
18x36	457x914	5A336BC	5A336EC
18x48	457x1219	5A356BC	5A356EC
18x60	457x1524	5A366BC	5A366EC
21x36	530x914	5A436BC	5A436EC
21x48	530x1219	5A456BC	5A456EC
21x60	530x1524	5A466BC	5A466EC
24x36	610x914	5A536BC	5A536EC
24x48	610x1219	5A556BC	5A556EC
24x60	610x1524	5A566BC	5A566EC

COMPLETE UNIT HEIGHT
80" (2032mm)

4-Shelf Mobile Chrome Unit with 74" Posts

Nominal Width/Length (in.)	Nominal Width/Length (mm)	Polyurethane Casters
		(2) Swivel, (2) Brake
18x36	457x914	SA-183680C-MU-4
18x48	457x1219	SA-184880C-MU-4
18x60	457x1524	SA-186080C-MU-4
18x72	457x1829	SA-187280C-MU-4
24x36	610x914	SA-243680C-MU-4
24x48	610x1219	SA-244880C-MU-4
24x60	610x1524	SA-246080C-MU-4
24x72	610x1829	SA-247280C-MU-4

For Super Adjustable Super Erecta, order from page 42.



The easiest way to build Shelving.



SUPER ADJUSTABLE SUPER ERECTA® SHELVING CARTS



Standard Wire Cart
ECN56CA

Perfect for:
**Healthcare
Par Level**



Deluxe Wire Cart
ECM56CD



Deluxe Dolly Truck
ECN56CC

Super Adjustable Super Erecta® Wire Carts

Patented release lever to allows for easy reconfiguration of shelves as supply dimensions change. Optional dividers, ledges, enclosure panels, Super Erecta® Slides and tote boxes in various combinations, can be added, removed or reconfigured to adapt to change. Also available in stainless steel. Cart covers are available.

Standard Wire Cart

Includes four chrome-plated adjustable wire shelves, one solid bottom shelf, chrome-plated posts, 5" (127mm) high-modulus donut stem casters (two with brakes), and six label holders.

Shelf Width/Length (mm)		Overall Height (mm)		Cat. No. with Galvanized Bottom Shelf	Cat. No. with Stainless Bottom Shelf
21x48	530x1219	67.87	1724	ECN45CA	ECM45XA
21x60	530x1524	67.87	1724	ECN46CA	ECM46XA
24x48	610x1219	67.87	1724	ECN55CA	ECM55XA
24x60	610x1524	67.87	1724	ECN56CA	ECM56XA

Wire Cart

Includes four chrome-plated adjustable wire shelves, one solid bottom shelf, chrome-plated posts, 5" (127mm) high-modulus donut stem casters (two with brakes), side and back enclosure panels, one or two Super Slides, two or four 6" (152mm) deep tote boxes with box dividers, four or six shelf dividers and twelve label holders.

Shelf Width/Length (mm)		Overall Height (mm)	Tote Boxes 6" (152mm) Deep	Shelf Dividers	Super Slides	Cat. No. with Galvanized Bottom Shelf	Cat. No. with Stainless Bottom Shelf
24x48	610x1219	67.87	2	4	1	ECN55CD	ECM55XD
24x60	610x1524	67.87	4	6	2	ECN56CD	ECM56XD

Standard Dolly Truck

Includes four chrome-plated adjustable wire shelves, one solid bottom shelf, chrome-plated posts, aluminum dolly frame with wraparound bumper, 8" (203mm) resilient casters (two with swivel locks), and six label holders.

Shelf Width/Length (mm)		Overall Height (mm)	Cat. No. with Galvanized Bottom Shelf	Cat. No. with Stainless Bottom Shelf
21x48	530x1219	71.69	ECN45CS	ECM45XS
21x60	530x1524	71.69	ECN46CS	ECM46XS
24x48	610x1219	71.69	ECN55CS	ECM55XS
24x60	610x1524	71.69	ECN56CS	ECM56XS

Deluxe Dolly Truck

Includes four chrome-plated adjustable wire shelves, one solid bottom shelf, chrome-plated posts, aluminum dolly frame with wraparound bumper, 8" (203mm) resilient casters (two with swivel locks), side and back enclosure panels, one or two Super Slides, two or four 6" (152mm) deep tote boxes with box dividers, four or six shelf dividers and twelve label holders. Overall height: 71.69 (1821mm).

Shelf Width/Length (mm)		Tote Boxes 6" (152mm) Deep	Shelf Dividers	Super Slides	Cat. No. with Galvanized Bottom Shelf	Cat. No. with Stainless Bottom Shelf
24x48	610x1219	2	4	1	ECN55CC	ECM55XC
24x60	610x1524	4	6	2	ECN56CC	ECM56XC

SUPER ERECTA® SHELVING SYSTEM



Genuine Metro



LEARN MORE



The easiest way to build Shelving.



SHELVING ASSEMBLY



Super Erecta® Shelving System The original wire storage system.

A storage system that defines the extent of space, Super Erecta's revolutionary concept was fresh and innovative from its start — nearly 50 years ago. It has continued to evolve, with nearly 100 highly specialized accessories, aimed at meeting the diversity of today's challenges.

- Adjustable: Shelves can be set and repositioned at precise 1" (25mm) increments along the length of the numbered posts.
- Unique Design: Open-wire design minimizes dust accumulation, allows a free circulation of air, and greater visibility of stored items.
- Mobile: Full choice of caster types available for mobile applications.



SiteSelect posts provide a visual guide for positioning and adjusting shelves, saving considerable time during assembly and adjustment. An easy-to-identify double groove, every 8" (203mm), offers a quick way to align all shelves.



SUPER ERECTA® SHELVING SYSTEM

Available Finishes



Wire & Solid



Type 304 Polished Stainless Steel
Addresses the most aggressive applications and environments. All-stainless solid and wire options exist for high temperature automated cart wash and autoclave applications.

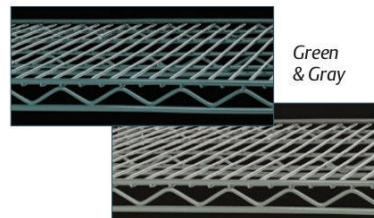

Green & Gray



Metroseal™ Epoxy
Corrosion resistant finish for wet or high humidity environments with a 12-year warranty against rust and corrosion. Microban antimicrobial is built into the finish to keep the product "cleaner between cleanings."



Chrome Plating

Nickel-chrome finish for dry, low humidity environments. Metro's durable chrome finish includes a protective lacquer coat.



Brite

Economical, chromate finish for dry, low humidity environments. Metro's Brite finish provides the look of chrome and includes a protective lacquer coat.



Standard Epoxy and Designer Finishes

A pleasing aesthetic and basic protection for dry environments.



Available Posts

Standard Stationary Post with adjustable leveling foot. Stainless models also feature a stainless leveling foot. Use Foot Plates for greater stability.

Standard Mobile-Ready Posts accept Metro stem casters. Use these for the majority of standard duty transport and movable storage applications.

Cart Wash and Autoclave Applications

Swaged stainless post has a fastened aluminum post cap and is specifically designed to withstand high temperatures. See page 59 for part numbers.

Heavy Duty Transport

Staked post attaches to a dolly truck to address abusive transport applications. The reinforced connection between the base receptacle and post provides a more secure connection to the dolly truck. See page 60 for part numbers.



1.800.992.1776 • WWW.METRO.COM

47

SUPER ERECTA® SHELVING SYSTEM



Wire Shelves — {10.01a} {10.10a}

Weight capacity is 800 lbs. (363kg) per shelf for lengths of 18" to 48" (457 to 1219mm) 600 lbs. (272kg) for lengths of 54" (1370mm) or longer. Stationary units have a maximum capacity of 2,000 lbs. (907kg). Mobile units have a maximum capacity of three times the caster load rating up to but not exceeding 1,000 lbs. (453kg) total.



The easiest way to build Shelving.

Nominal Width/Length (in.)	(mm)	Cat. No. Super Erecta Brite	Cat. No. Chrome	Cat. No. Metroseal Green (K3) with Microban	Cat. No. Metroseal Gray (K4) with Microban	Cat. No. Stainless
14x24	355x610	1424BR	1424NC	1424NK3	1424NK4	1424NS
14x30	355x760	1430BR	1430NC	1430NK3	1430NK4	1430NS
14x36	355x914	1436BR	1436NC	1436NK3	1436NK4	1436NS
14x42	355x1066	1442BR	1442NC	1442NK3	1442NK4	1442NS
14x48	355x1219	1448BR	1448NC	1448NK3	1448NK4	1448NS
14x60	355x1524	1460BR	1460NC	1460NK3	1460NK4	1460NS
14x72	355x1829	1472BR	1472NC	1472NK3	1472NK4	1472NS
18x18	457x457	-	1818NC	1818NK3	1818NK4	-
18x24	457x610	1824BR	1824NC	1824NK3	1824NK4	1824NS
18x30	457x760	1830BR	1830NC	1830NK3	1830NK4	1830NS
18x36	457x914	1836BR	1836NC	1836NK3	1836NK4	1836NS
18x42	457x1066	1842BR	1842NC	1842NK3	1842NK4	1842NS
18x48	457x1219	1848BR	1848NC	1848NK3	1848NK4	1848NS
18x54	457x1370	1854BR	1854NC	1854NK3	1854NK4	1854NS
18x60	457x1524	1860BR	1860NC	1860NK3	1860NK4	1860NS
18x72	457x1829	1872BR	1872NC	1872NK3	1872NK4	1872NS
21x24	530x610	2124BR	2124NC	2124NK3	2124NK4	2124NS
21x30	530x760	2130BR	2130NC	2130NK3	2130NK4	2130NS
21x36	530x914	2136BR	2136NC	2136NK3	2136NK4	2136NS
21x42	530x1066	2142BR	2142NC	2142NK3	2142NK4	2142NS
21x48	530x1219	2148BR	2148NC	2148NK3	2148NK4	2148NS
21x54	530x1370	2154BR	2154NC	2154NK3	2154NK4	2154NS
21x60	530x1524	2160BR	2160NC	2160NK3	2160NK4	2160NS
21x72	530x1829	2172BR	2172NC	2172NK3	2172NK4	2172NS
24x24	610x610	2424BR	2424NC	2424NK3	2424NK4	2424NS
24x30	610x760	2430BR	2430NC	2430NK3	2430NK4	2430NS
24x36	610x914	2436BR	2436NC	2436NK3	2436NK4	2436NS
24x42	610x1066	2442BR	2442NC	2442NK3	2442NK4	2442NS
24x48	610x1219	2448BR	2448NC	2448NK3	2448NK4	2448NS
24x54	610x1370	2454BR	2454NC	2454NK3	2454NK4	2454NS
24x60	610x1524	2460BR	2460NC	2460NK3	2460NK4	2460NS
24x72	610x1829	2472BR	2472NC	2472NK3	2472NK4	2472NS

Note: The actual length of the shelves is .12" (3.2mm) shorter than the nominal dimension shown. The actual depth of the shelves is .12" (3.2mm) greater than the nominal dimension shown.

SHELVING HEIGHT GUIDELINES						
Shelf Depth	14" (356mm)	18" (457mm)	21" (533mm)	24" (610mm)	30" (762mm)	36" (914mm)
Maximum Allowable Post Height						
Stationary	63" (1600mm)	86" (2184mm)	86" (2184mm)	96" (2438mm)	96" (2438mm)	96" (2438mm)
Mobile	54" (1372mm)	74" (1880mm)	74" (1880mm)	86" (2184mm)	86" (2184mm)	86" (2184mm)

Note: For stationary units with foot plates or wall brackets properly attached to the floor or wall, the maximum allowable height is 96" (2438mm).



SUPER ERECTA® SHELVING SYSTEM

Super Wide Shelving — {10.01a} {10.10a}

30" & 36" wide shelves are best for large quantities of supplies or large, bulky objects.

Cat. No. Chrome	Cat. No. Metroseal Green	Cat. No.. Metroseal Gray	Cat. No. Stainless Steel	Width/Length		Pkd. Wt.	
				(in.)	(mm)	(lbs.)	(kg)
3036NC	3036NK3	3036NK4	3036NS	30x36	760x914	14.2	6.4
3048NC	3048NK3	3048NK4	3048NS	30x48	760x1219	17.7	8.0
3060NC	3060NK3	3060NK4	3060NS	30x60	760x1524	20.2	9.2
3072NC	3072NK3	3072NK4	3072NS	30x72	760x1829	22.7	10.3
3636NC	3636NK3	-	3636NS	36x36	910x914	16.7	7.6
3648NC	3648NK3	-	3648NS	36x48	910x1219	21.6	9.8
3660NC	3660NK3	-	3660NS	36x60	910x1524	26.4	12.0
3672NC	3672NK3	-	3672NS	36x72	910x1829	31.6	14.3

Load Capacity Per Shelf 800 lbs. (363kg) for lengths 48" (1219mm) or shorter. 600 lbs. (272kg) for lengths 54" (1370mm) or longer.



SiteSelect® Posts — {10.01a} {10.10a}

Stationary Super Erecta® SiteSelect posts are fitted with adjustable leveling bolts. Mobile posts come without leveling bolt assembly to accommodate stem casters.

Stationary Posts

Cat. No. Chrome	Cat. No. Metroseal Green (K3) with Microban	Cat. No.. Metroseal Gray (K4) with Microban	Cat. No. Stainless Steel	Actual Height		Approx. Pkd. Wt.	
				(in.)	(mm)	(lbs.)	(kg)
7P	7PK3	7PK4	-	7.4	187	0.5	0.3
13P	13PK3	13PK4	13PS	14.4	365	1	0.5
27P	27PK3	27PK4	27PS	28.4	720	1.75	0.75
33P	33PK3	33PK4	33PS	34.4	873	2	0.9
54P	54PK3	54PK4	54PS	54.4	1382	3	1.4
63P	63PK3	63PK4	63PS	62.4	1585	3.5	1.6
74P	74PK3	74PK4	74PS	74.5	1892	4	1.8
86P	86PK3	86PK4	86PS	86.5	2197	5	2.3
*96P	-	-	-	96.5	2450	5.5	2.5

*96P should not be used on units less than 24" (610mm) deep. Consult Metro Engineering for alternate recommendations.



SiteSelect Posts feature double grooves every 8" (203mm) to aid assembly.



Stationary Post

Mobile Posts (For use with Stem Casters)

Cat. No. Chrome	Cat. No. Metroseal Green (K3) with Microban	Cat. No. Metroseal Gray (K4) with Microban	Cat. No. Stainless Steel	Actual Height		Approx. Pkd. Wt.	
				(in.)	(mm)	(lbs.)	(kg)
13UP	13UPK3	13UPK4	13UPS	13.75	349	1	0.5
27UP	27UPK3	27UPK4	27UPS	27.75	704	1.75	0.75
33UP	33UPK3	33UPK4	33UPS	33.75	857	2	0.9
54UP	54UPK3	54UPK4	54UPS	53.8	1366	3	1.4
63UP	63UPK3	63UPK4	63UPS	61.8	1570	3.5	1.6
-	70UPK3	70UPK4	-	69.75	1771	3.75	1.7
74UP	74UPK3	74UPK4	74UPS	73.9	1876	4	1.8
86UP	86UPK3	86UPK4	86UPS	85.9	2181	4.5	2.0



Post for Stem Caster

Staked Posts (For use with Truck Dollies)

- Each post connects to the truck dolly through the stem receptacle. The stem receptacle is staked into the bottom of the post for abusive mobile applications. Each includes a leveling/connecting bolt.

Cat. No. Chrome	Cat. No. Stainless Steel	Height		Pkd. Wt.	
		(in.)	(mm)	(lbs.)	(kg)
54P-STKD	54PS-STKD	54.4	1382	3	1.4
63P-STKD	63PS-STKD	62.4	1585	3.5	1.6
74P-STKD	74PS-STKD	74.5	1892	4	1.8

Swaged Posts (For use with Stem Casters in Cart Wash Applications)

- Each post has an aluminum cap swaged into the top of the post.

Cat. No. Stainless Steel	Height		Pkd. Wt.	
	(in.)	(mm)	(lbs.)	(kg)
33UPS-SW	33.75	857	2	.9
54UPS-SW	53.8	1366	3	1.4
63UPS-SW	61.8	1570	3.5	1.6



Staked Post



Swaged Post

Special Length Posts

Cut posts are available. Consult your Metro representative for more information.

1.800.992.1776 • WWW.METRO.COM

SUPER ERECTA® SHELVING SYSTEM



Designer Color Shelving — {10.14}

Width/Length (in.)	(mm)	Pkd. Wt. (lbs.)	(kg)	Cat. No. Black	Cat. No. White	Cat. No. Smoked Glass	Cat. No. Copper Hammetone†
14x24	355x610	6	2.7	1424NBL	1424NW	1424N-DSG	1424N-DCH
14x30	355x760	7	3.2	1430NBL	1430NW	1430N-DSG	1430N-DCH
14x36	355x914	8	3.6	1436NBL	1436NW	1436N-DSG	1436N-DCH
14x42	355x1066	9.5	4.3	1442NBL	1442NW	1442N-DSG	1442N-DCH
14x48	355x1219	10.5	4.7	1448NBL	1448NW	1448N-DSG	1448N-DCH
14x60	355x1524	14	6.3	1460NBL	1460NW	1460N-DSG	1460N-DCH
14x72	355x1829	17	7.7	1472NBL	1472NW	1472N-DSG	1472N-DCH
18x18	457x457	6	2.7	1818NBL	1818NW	1818N-DSG	1818N-DCH
18x24	457x610	7	3.2	1824NBL	1824NW	1824N-DSG	1824N-DCH
18x30	457x760	8	3.6	1830NBL	1830NW	1830N-DSG	1830N-DCH
18x36	457x914	9.5	4.3	1836NBL	1836NW	1836N-DSG	1836N-DCH
18x42	457x1066	11	5.0	1842NBL	1842NW	1842N-DSG	1842N-DCH
18x48	457x1219	12	5.4	1848NBL	1848NW	1848N-DSG	1848N-DCH
18x54	457x1370	14.5	6.6	1854NBL	1854NW	1854N-DSG	1854N-DCH
18x60	457x1524	17	7.7	1860NBL	1860NW	1860N-DSG	1860N-DCH
18x72	457x1829	20	9.1	1872NBL	1872NW	1872N-DSG	1872N-DCH
21x24	530x610	8	3.6	2124NBL	2124NW	2124N-DSG	2124N-DCH
21x30	530x760	9	4.1	2130NBL	2130NW	2130N-DSG	2130N-DCH
21x36	530x914	11	5.0	2136NBL	2136NW	2136N-DSG	2136N-DCH
21x42	530x1066	12	5.4	2142NBL	2142NW	2142N-DSG	2142N-DCH
21x48	530x1219	14	6.4	2148NBL	2148NW	2148N-DSG	2148N-DCH
21x54	530x1370	16	7.3	2154NBL	2154NW	2154N-DSG	2154N-DCH
21x60	530x1524	18	8.2	2160NBL	2160NW	2160N-DSG	2160N-DCH
21x72	530x1829	24	10.9	2172NBL	2172NW	2172N-DSG	2172N-DCH
24x24	610x610	9	4.1	2424NBL	2424NW	2424N-DSG	2424N-DCH
24x30	610x760	11	5.0	2430NBL	2430NW	2430N-DSG	2430N-DCH
24x36	610x914	13	5.9	2436NBL	2436NW	2436N-DSG	2436N-DCH
24x42	610x1066	15	6.8	2442NBL	2442NW	2442N-DSG	2442N-DCH
24x48	610x1219	16	7.3	2448NBL	2448NW	2448N-DSG	2448N-DCH
24x54	610x1370	19	8.6	2454NBL	2454NW	2454N-DSG	2454N-DCH
24x60	610x1524	21	9.5	2460NBL	2460NW	2460N-DSG	2460N-DCH
24x72	610x1829	26	11.8	2472NBL	2472NW	2472N-DSG	2472N-DCH

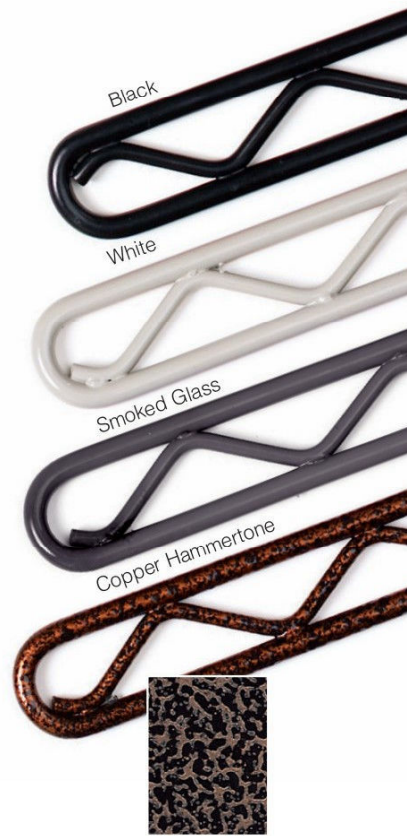

Note: White epoxy Super Erecta shelves come with white split sleeves.
 Note: All Black, Smoked Glass and Designer Super Erecta shelves come with black split sleeves.
 Note: Black shelving is NSF listed. White, Smoked Glass, and Designer Colors are not NSF listed.

Posts — {10.14}

Stationary Posts

Height* (in.)	(mm)	Pkd. Wt. (lbs.)	(kg)	Cat. No. Black	Cat. No. White	Cat. No. Smoked Glass	Cat. No. Copper Hammetone
7.4	191	0.5	0.3	7PBL	7PW	7P-DSG	7P-DCH
14.4	370	1	0.5	13PBL	13PW	13P-DSG	13P-DCH
28.4	699	1.75	.75	27PBL	27PW	27P-DSG	27P-DCH
34.4	875	2	0.9	33PBL	33PW	33P-DSG	33P-DCH
54.4	1385	3	1.4	54PBL	54PW	54P-DSG	54P-DCH
62.4	1590	3.5	1.6	63PBL	63PW	63P-DSG	63P-DCH
74.5	1895	4	1.8	74PBL	74PW	74P-DSG	74P-DCH
86.5	2200	5	2.3	86PBL	86PW	86P-DSG	86P-DCH

Mobile Posts

Height* (in.)	(mm)	Cat. No. Black	Cat. No. White	Cat. No. Smoked Glass	Cat. No. Copper Hammetone
—	—	—	—	—	—
27.75	699	27UPBL	27UPW	27UP-DSG	27UP-DCH
33.75	875	33UPBL	33UPW	33UP-DSG	33UP-DCH
53.8	1358	54UPBL	54UPW	54UP-DSG	54UP-DCH
61.8	1590	63UPBL	63UPW	63UP-DSG	63UP-DCH
73.9	2200	74UPBL	74UPW	74UP-DSG	74UP-DCH
85.9	2454	86UPBL	86UPW	86UP-DSG	86UP-DCH



The easiest way
to build Shelving.



SUPER ERECTA® SHELVING SYSTEM

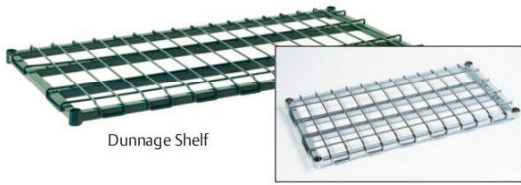

Dunnage Shelf

Heavy-Duty Dunnage Shelves — {10.45}

Enhance the weight-bearing capacity. 36" (914mm) shelf holds 1,600 pounds (725kg) (uniformly distributed); 48" (1219mm) shelves carry up to 1,300 pounds (590kg); 60" (1524mm) shelves bear up to 1,000 pounds (453kg).

- Removable wire mat: Lifts off for easy cleaning. .31" (7.9mm) diameter wire. Support frames: 1" (25mm) square tubing.

Width/Length (in.)	Width/Length (mm)	Cat. No. Chrome	Cat. No. Metroseal Green with Microban®	Cat. No. Stainless
18x24	457x610	1824DRC	1824DRK3	-
18x30	457x760	1830DRC	1830DRK3	-
18x36	457x914	1836DRC	1836DRK3	1836DRS
18x48	457x1219	1848DRC	1848DRK3	1848DRS
18x60	457x1524	1860DRC	1860DRK3	1860DRS
21x24	530x610	-	2124DRK3	-
21x30	530x760	-	2430DRK3	-
21x36	530x914	-	2436DRK3	-
21x48	530x1219	-	2448DRK3	-
21x60	530x1524	-	2460DRK3	-
24x24	610x610	2424DRC	2424DRK3	-
24x30	610x760	2430DRC	2430DRK3	-
24x36	610x914	2436DRC	2436DRK3	2436DRS
24x48	610x1219	2448DRC	2448DRK3	2448DRS
24x60	610x1524	2460DRC	2460DRK3	2460DRS

Important: In stationary shelving, stability decreases as the ratio of height to width increases and when heavier loads are placed on upper shelves. Shelving stability is attained by keeping units as wide and low as possible, and placing heavy loads low on the shelving unit.

Cantilever Shelves — {10.05}

Adds convenient space above a storage unit. Drop mat design creates a retaining ledge around the entire 12" (305mm) deep shelf. Remember to order rear posts taller than front posts to accommodate these shelves.

Length (in.)	Length (mm)	Approx. Pkd. Wt. Each (lbs./kg)		Cat. No. Chrome	Cat. No. Black	Cat. No. White	Cat. No. Smoked Glass
24	610	4.5	2.0	1224CSNC	1224CSNBL	1224CSNW	1224CSN-DSG
30	750	5	2.3	1230CSNC	1230CSNBL	1230CSNW	1230CSN-DSG
36	914	5.75	2.6	1236CSNC	1236CSNBL	1236CSNW	1236CSN-DSG
42	1066	6.75	3.1	1242CSNC	1242CSNBL	1242CSNW	1242CSN-DSG
48	1219	7.75	3.5	1248CSNC	1248CSNBL	1248CSNW	1248CSN-DSG
60	1524	9.5	4.3	1260CSNC	1260CSNBL	1260CSNW	1260CSN-DSG



Cantilever Shelves

Super Erecta® Convenience Pack — {10.03}

- A complete shelving unit in a single box — the easy-to-order alternative to separate shelving components.
- Available in Super Erecta Brite, chrome and Metroseal Green

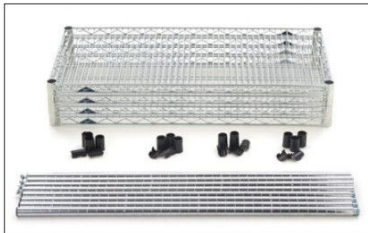

Unassembled Convenience Pack

Each pack includes four shelves with split sleeves and four split posts with threaded connectors and leveling feet.



Width/Length/Height (in.)	Width/Length/Height (mm)	Approx. Pkd. Wt. (lbs./kg)		Cat. No. Super Erecta Brite	Cat. No. Chrome	Cat. No. Metroseal 3 with Microban®
18x36x74.5	457x914x1890	51	23	EZ1836BR-4	EZ1836NC-4	EZ1836NK3-4
18x48x74.5	457x1219x1890	63	28.5	EZ1848BR-4	EZ1848NC-4	EZ1848NK3-4
18x60x74.5	457x1524x1890	82	37	EZ1860BR-4	EZ1860NC-4	EZ1860NK3-4
24x36x74.5	610x914x1890	66	30	EZ2436BR-4	EZ2436NC-4	EZ2436NK3-4
24x48x74.5	610x1219x1890	76	34.5	EZ2448BR-4	EZ2448NC-4	EZ2448NK3-4
24x60x74.5	610x1524x1890	102	46	EZ2460BR-4	EZ2460NC-4	EZ2460NK3-4

Indicates antimicrobial product.

1.800.992.1776 • WWW.METRO.COM

SUPER ERECTA® STARTER AND ADD-ON UNITS



Shelving Starter and Add-On Units — {10.90}

- Starter Units consist of four posts and indicated number of Super Erecta shelves.
- Add-On Units consist of two posts, indicated number of shelves, and two "S" Hooks per shelf, for attaching shelf to adjacent unit.

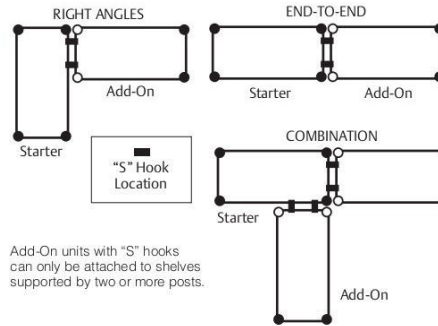

Chrome Finish

Brite Finish

Nominal Width/Length (in.)	Nominal Width/Length (mm)	4-Shelf Chrome Unit with 63" Posts		4-Shelf Chrome Unit with 74" Posts		5-Shelf Chrome Unit with 74" Posts		4-Shelf Brite Unit with 63" Posts		5-Shelf Brite Unit with 74" Posts	
		Cat. No. Starter Unit	Cat. No. Add-On Unit	Cat. No. Starter Unit	Cat. No. Add-On Unit	Cat. No. Starter Unit	Cat. No. Add-On Unit	Cat. No. Starter Unit	Cat. No. Add-On Unit	Cat. No. Starter Unit	Cat. No. Add-On Unit
18x24	457x610	N316C	AN316C	-	5N317C	5AN317C	N316BR	AN316BR	5N317BR	5AN317BR	
18x30	457x760	N326C	AN326C	-	5N327C	5AN327C	N326BR	AN326BR	5N327BR	5AN327BR	
18x36	457x914	N336C	AN336C	N337C	5N337C	5AN337C	N336BR	AN336BR	5N337BR	5AN337BR	
18x42	457x1060	N346C	AN346C	N347C	5N347C	5AN347C	N346BR	AN346BR	5N347BR	5AN347BR	
18x48	457x1219	N356C	AN356C	N357C	5N357C	5AN357C	N356BR	AN356BR	5N357BR	5AN357BR	
18x60	457x1524	N366C	AN366C	N367C	5N367C	5AN367C	N366BR	AN366BR	5N367BR	5AN367BR	
18x72	457x1829	N376C	AN376C	N377C	5N377C	5AN377C	N376BR	AN376BR	5N377BR	5AN377BR	
21x24	530x610	N416C	AN416C	-	5N417C	5AN417C	N416BR	AN416BR	5N417BR	5AN417BR	
21x30	530x760	N426C	AN426C	-	5N427C	5AN427C	N426BR	AN426BR	5N427BR	5AN427BR	
21x36	530x914	N436C	AN436C	-	5N437C	5AN437C	N436BR	AN436BR	5N437BR	5AN437BR	
21x42	530x1060	N446C	AN446C	-	5N447C	5AN447C	N446BR	AN446BR	5N447BR	5AN447BR	
21x48	530x1219	N456C	AN456C	-	5N457C	5AN457C	N456BR	AN456BR	5N457BR	5AN457BR	
21x60	530x1524	N466C	AN466C	-	5N467C	5AN467C	N466BR	AN466BR	5N467BR	5AN467BR	
21x72	530x1829	N476C	AN476C	-	5N477C	5AN477C	N476BR	AN476BR	5N477BR	5AN477BR	
24x24	610x610	N516C	AN516C	-	5N517C	5AN517C	N516BR	AN516BR	5N517BR	5AN517BR	
24x30	610x760	N526C	AN526C	-	5N527C	5AN527C	N526BR	AN526BR	5N527BR	5AN527BR	
24x36	610x914	N536C	AN536C	N537C	5N537C	5AN537C	N536BR	AN536BR	5N537BR	5AN537BR	
24x42	610x1060	N546C	AN546C	N547C	5N547C	5AN547C	N546BR	AN546BR	5N547BR	5AN547BR	
24x48	610x1219	N556C	AN556C	N557C	5N557C	5AN557C	N556BR	AN556BR	5N557BR	5AN557BR	
24x60	610x1524	N566C	AN566C	N567C	5N567C	5AN567C	N566BR	AN566BR	5N567BR	5AN567BR	
24x72	610x1829	N576C	AN576C	N577C	5N577C	5AN577C	N576BR	AN576BR	5N577BR	5AN577BR	

Actual Dimensions: Width: Add .12" (3.2mm) to nominal size. Length: Subtract .12" (3.2mm) from nominal size.

For additional wire shelves, order from page 48.



Replacement "S" Hook

2 are required for each storage level.
Cat. No. 9995Z



Security "S" Hook

2 are required for each storage level. Bag of 2.
Chrome. Cat. No. H9995C
Black. Cat. No. H9995B



SUPER ERECTA® STARTER AND ADD-ON UNITS



Metroseal Epoxy Coating



Zinc chromate plated steel

Added layer of protection.

Supplement your cleaning process and stop bacteria in its tracks with built-in Microban® antimicrobial product protection.



WHAT IS MICROBAN?

Metroseal Green Finish



4-Shelf Metroseal Green Unit with 63" posts

5-Shelf Metroseal Green Unit with 74" posts

Nominal Width/Length (in./mm)		Cat. No. Starter Unit	Cat. No. Add-On Unit	Cat. No. Starter Unit	Cat. No. Add-On Unit
18x24	457x610	N316K3	AN316K3	5N317K3	5AN317K3
18x30	457x760	N326K3	AN326K3	5N327K3	5AN327K3
18x36	457x914	N336K3	AN336K3	5N337K3	5AN337K3
18x42	457x1060	N346K3	AN346K3	5N347K3	5AN347K3
18x48	457x1219	N356K3	AN356K3	5N357K3	5AN357K3
18x54	457x1370	-	-	-	-
18x60	457x1524	N366K3	AN366K3	5N367K3	5AN367K3
18x72	457x1829	N376K3	AN376K3	5N377K3	5AN377K3
21x24	530x610	N416K3	AN416K3	5N417K3	5AN417K3
21x30	530x760	N426K3	AN426K3	5N427K3	5AN427K3
21x36	530x914	N436K3	AN436K3	5N437K3	5AN437K3
21x42	530x1060	N446K3	AN446K3	5N447K3	5AN447K3
21x48	530x1219	N456K3	AN456K3	5N457K3	5AN457K3
21x54	530x1370	-	-	-	-
21x60	530x1524	N466K3	AN466K3	5N467K3	5AN467K3
21x72	530x1829	N476K3	AN476K3	5N477K3	5AN477K3
24x24	610x610	N516K3	AN516K3	5N517K3	5AN517K3
24x30	610x760	N526K3	AN526K3	5N527K3	5AN527K3
24x36	610x914	N536K3	AN536K3	5N537K3	5AN537K3
24x42	610x1060	N546K3	AN546K3	5N547K3	5AN547K3
24x48	610x1219	N556K3	AN556K3	5N557K3	5AN557K3
24x54	610x1370	-	-	-	-
24x60	610x1524	N566K3	AN566K3	5N567K3	5AN567K3
24x72	610x1829	N576K3	AN576K3	5N577K3	5AN577K3

Actual Dimensions: Width: Add .12" (3.2mm) to nominal size. Length: Subtract .12" (3.2mm) from nominal

For additional Super Erecta wire shelves, order from page 48.

Metroseal Gray Finish



4-Shelf Metroseal Gray Unit with 63" posts

4-Shelf Metroseal Gray Unit with 74" posts

Cat. No. Starter Unit	Cat. No. Add-On Unit
SE-182463K4-S-4	SE-182474K4-S-4
SE-183063K4-S-4	SE-183074K4-S-4
SE-183663K4-S-4	SE-183674K4-S-4
SE-184263K4-S-4	SE-184274K4-S-4
SE-184863K4-S-4	SE-184874K4-S-4
SE-185463K4-S-4	SE-185474K4-S-4
SE-186063K4-S-4	SE-186074K4-S-4
SE-187263K4-S-4	SE-187274K4-S-4
SE-212463K4-S-4	SE-212474K4-S-4
SE-213063K4-S-4	SE-213074K4-S-4
SE-213663K4-S-4	SE-213674K4-S-4
SE-214263K4-S-4	SE-214274K4-S-4
SE-214863K4-S-4	SE-214874K4-S-4
SE-215463K4-S-4	SE-215474K4-S-4
SE-216063K4-S-4	SE-216074K4-S-4
SE-217263K4-S-4	SE-217274K4-S-4
SE-242463K4-S-4	SE-242474K4-S-4
SE-243063K4-S-4	SE-243074K4-S-4
SE-243663K4-S-4	SE-243674K4-S-4
SE-244263K4-S-4	SE-244274K4-S-4
SE-244863K4-S-4	SE-244874K4-S-4
SE-245463K4-S-4	SE-245474K4-S-4
SE-246063K4-S-4	SE-246074K4-S-4
SE-247263K4-S-4	SE-247274K4-S-4

Add-on units with "S" hooks can only be attached to shelves supported by two or more posts.

☑ Indicates antimicrobial product.

1.800.992.1776 • WWW.METRO.COM

SUPER ERECTA® SHELVING CARTS



Standard-Duty Stem Caster Carts



(Standard-Duty Mobile Shelving)

- The most common configuration for mobile shelving.
- They are primarily used for applications where the shelving is periodically moved to clean or to transport goods short distances within a facility.
- The weight capacity of the cart is determined by the casters. Typical configurations range from 600-900 lbs. (272-363kg) total unit capacity.



Wire Stem Caster Cart

Stem Caster Carts — Wire — {11.01}

Open-wire shelf design minimizes dust and increases air circulation and visibility. Casters included. Overall Height 67.9" (1724mm). Carts are configured with 63UP posts.

Shelf Width/Length (in./mm)	Approx. Pkd. Wt. (lbs./kg)	Super Erecta Brite Finish		Chrome Finish		
		Two Swivel Two Brake Resilient Rubber Casters	Two Swivel Two Brake Polyurethane Casters	Two Swivel Two Brake Resilient Rubber Casters	Two Swivel Two Brake Polyurethane Casters	
18x36	457x914	60 27	N336BBR	N336EBR	N336BC	N336EC
18x48	457x1219	72 32	N356BBR	N356EBR	N356BC	N356EC
18x60	457x1524	88 40	N366BBR	N366EBR	N366BC	N366EC
21x36	530x914	69 31	N436BBR	N436EBR	N436BC	N436EC
21x48	530x1219	81 36	N456BBR	N456EBR	N456BC	N456EC
21x60	530x1524	98 44	N466BBR	N466EBR	N466BC	N466EC
24x36	610x914	76 34	N536BBR	N536EBR	N536BC	N536EC
24x48	610x1219	92 41	N556BBR	N556EBR	N556BC	N556EC
24x60	610x1524	112 51	N566BBR	N566EBR	N566BC	N566EC

Note: Models with Resilient Rubber casters can hold up to 600 lbs. (272kg) evenly distributed. Models with Polyurethane casters can hold up to 900 lbs. (409kg) evenly distributed.



Solid Stem Caster with galvanized shelves

Stem Caster Carts — Solid — {11.10}

- Consist of four galvanized flat shelves, chrome plated 63" (1600mm) posts, plastic split sleeves, donut bumpers and 5" (127mm) poly casters (2 swivel; 2 brake).
- Strong and versatile
- Solid Shelf Stem Caster Carts feature a .12" (3mm) raised "ship's edge" around perimeter of shelves to help contain spillage.

Overall Height 67.12" (1724mm)

Shelf Width/Length (in./mm)	Approx. Pkd. Wt. (lbs./kg)	Cat. No.	
24x36	610x914	100 45	F536EG
24x48	610x1219	124 56	F556EG
24x60	610x1524	152 69	F566EG

Note: Models are designed to hold up to 900 lbs. (363kg) evenly distributed.



SUPER ERECTA® SHELVING CARTS

Stem Caster Carts — Solid Stainless Steel Embossed

Description	Width (in.) (mm)	Length (in.) (mm)	Height (in.) (mm)	Casters (amt.) (type)	Approx. Pkd. Wt. (lbs.) (kg)	Cat. No.
Solid Embossed	24 610	48 1219	68 1727	2 5MP	125 56	PR48ES
Solid Embossed	24 610	60 1524	68 1727	2 5MP	153 66	PR60ES
				2 5MPB		

Embossed Stainless Shelves are perfect for Pot & Pan Drying Applications



Heavy-Duty Dolly Trucks



(Heavy-Duty Mobile Shelving)

- Carts configured with dolly bases are recommended for heavier duty applications. The dolly base is shock absorbent and the heavier duty plate casters are designed to withstand abusive conditions.
- Dolly trucks are recommended when the carts must travel longer distances, over thresholds, and/or between facilities on a regular basis.
- Dolly trucks can transport up to 1,000 lbs. (454kg) evenly distributed.

Super Erecta Dolly Trucks

Consist of four chrome wire shelves, aluminum dolly base, 63" (1600mm) plated posts, plastic split sleeves, donut bumpers and resilient rubber or poly casters as designated.

Shelf Width/Length (in.) (mm)	Approx. Pkd. Wt. (lbs.) (kg)	Catalog Number with Casters		
		Two BSDN Two BSDNB	Two BSP Two BSPB	Two 6P Set BL6P
24x36 610x914	96 43	N536JC	N536LC	N536MC
24x48 610x1219	118 53	N556JC	N556LC	N556MC
24x60 610x1524	142 64	N566JC	N566LC	N566MC

- Overall heights: JC, LC models — 68.44" (1739mm), MC models — 70.06" (1800mm).
- JC models: Standard swivel plate casters, two with brake, resilient rubber tread.
 - LC models: Standard swivel plate casters, two with brake, polyurethane tread.
 - MC models: Larger plate casters; two swivel, one swivel/brake set, polyurethane tread.



SUPER ERECTA® SHELVING CARTS



Slanted Shelf Rack

- Tote storage carts can hold up to twenty 10" (254mm) wide totes.
- Slanted shelves add visibility and accessibility. Loading is quick, easy and organized.
- Open-wire construction and slope of shelves permit instant identification.
- Shelves are adjustable at 1" (25mm) intervals along the height of the post.
- 5" (127mm) casters add mobility, while brakes lock firmly in position.
- Slanted shelf racks are commonly used as suture carts, picking carts with tote boxes, and for retail display.

Shelves	Length (in.) (mm)	Height (in.) (mm)	Approx. Pkd. Wt. (lbs.) (kg)	Cat. No.
Four Slanted Shelves One Flat Top Shelf (Pkg. of 12 dividers)	24 610	60 1524	103 46.3	DC15EC
Five Slanted Shelves (Pkg. of 12 dividers)	24 610	60 1524	112 50.4	DC16EC
Four Slanted Shelves One Flat Top Shelf	36 914	60 1524	95 42.7	DC35EC
Five Slanted Shelves	36 914	70 1778	104 46.8	DC36EC
Four Slanted Shelves One Flat Top Shelf	48 1219	60 1524	112 50.4	DC55EC
Five Slanted Shelves	48 1219	70 1778	123 55.3	DC56EC

Note: Weight Load Capacity (evenly distributed) 200lbs per shelf 400lbs per mobile unit 800lbs per stationary unit.



Slanted Shelf Rack
DC56EC

Additional Shelves

18" (457mm) wide.

Length (in.) (mm)	Approx. Pkd. Wt. (lbs.) (kg)	Cat. No.
24 610	10.5 4.7	1824DNC
36 914	14 6.3	1836DNC
48 1219	18 8.1	1848DNC

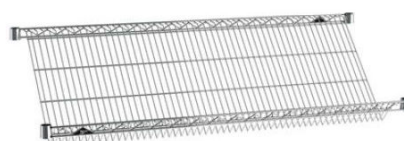

Additional Retainer

Helps separate merchandise.

Size Width/Length (in.) (mm)	Approx. Pkd. Wt. (lbs.) (kg)	Cat. No.
4x17 102x432	8 3.6	DCR17C



Slanted Shelving Transport Cart — {31.05}

Shelves slope backwards 2" (51mm) to keep items from falling during transport. Standard-duty carts have four polyurethane stem casters. Heavy-duty trucks are dolly mounted.

Width/Length (in.) (mm)	Height (in.) (mm)	No. Shelves	Casters	Description	Cat. No.
24x36 610x914	62.06 1577	3	2-BL6P, 2-6P	Heavy-Duty	AST35MC
24x48 610x1219	62.06 1577	3	2-BL6P, 2-6P	Heavy-Duty	AST55MC
24x60 610x1524	62.06 1577	3	2-BL6P, 2-6P	Heavy-Duty	AST65MC
24x36 610x914	59.87 1521	3	4-Poly Casters	Standard-Duty	AST35DC
24x48 610x1219	59.87 1521	3	4-Poly Casters	Standard-Duty	AST55DC
24x60 610x1524	59 7/8 1521	3	4-Poly Casters	Standard-Duty	AST65DC

Weight Load Capacity (evenly distributed) 800lbs per shelf. Up to 1000lbs per cart.

Additional Slanted Shelves

Width/Length (in.) (mm)	Cat. No. Chrome
24x36 610x914	SLT2436NC
24x48 610x1219	SLT2448NC
24x60 610x1524	SLT2460NC



Standard-Duty Slanted
Shelf Cart

Metro Design Tools

The easy way to customize & specify in 3D.



LEARN MORE



Metro has created these amazing, proprietary tools to help you build, layout, and specify select Metro products. These tools are **FREE** to use and can be accessed on metro.com.

Give it a try... they are super-simple.

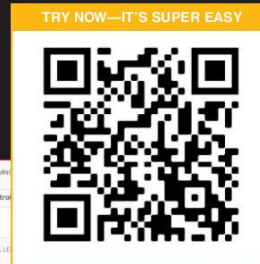
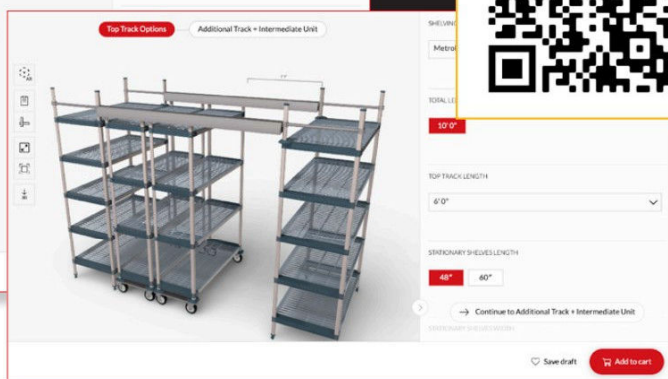
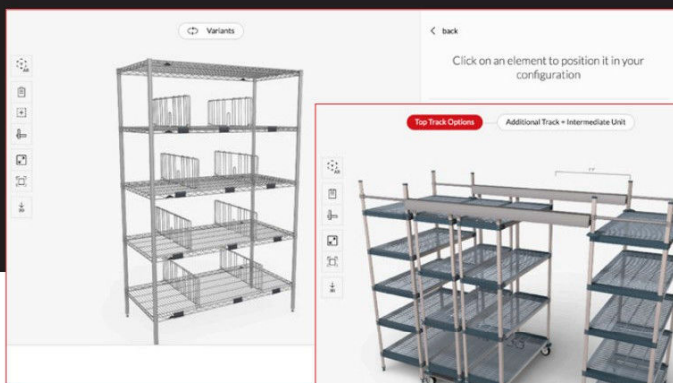

1.800.992.1776 • WWW.METRO.COM

57

SUPER ERECTA® STEM CASTERS



Castors for Dry Areas



GOOD

Plated Stem Casters — {11.20}

Plated caster horns and hardware for basic dry environments.



5LD



5MB



5MDBA



5MPB



5MPR

Wheel Diameter (in.)	Wheel Diameter (mm)	Face (in./mm)	Load Rating (lbs.)	Load Rating (kg)	Type	Wheel Tread	Temperature Range (Continuous Usage)		Cat. No.
							(Fahrenheit)	(Celsius)	
4	102	.5 12	125	56	Stem/Swivel	Resilient Donut	-20°-160°	-29°-71°	4LD
5	127	.5 12	125	56	Stem/Swivel	Resilient Donut	-20°-160°	-29°-71°	5LD
5	127	1.25 32	200	90	Stem/Swivel	Resilient, Flat	-20°-160°	-29°-71°	5M
5	127	1.25 32	200	90	Stem/Brake	Resilient, Flat	-20°-160°	-29°-71°	5MB
5	127	1.25 32	200	90	Stem/Rigid	Resilient, Flat	-20°-160°	-29°-71°	5MR
5	127	1.25 32	250	113	Stem/Swivel	High Modulus Donut	-20°-180°	-29°-82°	5MDA
5	127	1.25 32	250	113	Stem/Brake	High Modulus Donut	-20°-180°	-29°-82°	5MDBA
5	127	1.25 32	250	113	Stem/Rigid	High Modulus Donut	-20°-180°	-29°-82°	5MDRA
5	127	1.25 32	300	135	Stem/Swivel	Polyurethane, Flat	-20°-180°	-29°-82°	5MP
5	127	1.25 32	300	135	Stem/Brake	Polyurethane, Flat	-20°-180°	-29°-82°	5MPB
5	127	1.25 32	300	135	Stem/Rigid	Polyurethane, Flat	-20°-180°	-29°-82°	5MPR
6	152	1.5 38	400	182	Stem/Swivel	Polyurethane, Flat	-20°-180°	-29°-82°	6MP
6	152	1.5 38	400	182	Stem/Brake	Polyurethane, Flat	-20°-180°	-29°-82°	6MPB
6	152	1.5 38	400	182	Stem/Rigid	Polyurethane, Flat	-20°-180°	-29°-82°	6MPR

Note: Rigid casters are held in place by a connecting channel. When ordering, shelf width must be provided. Rigid connecting channel (stainless steel), Cat. No. 14RS, 18RS, 21RS, 24RS, 30RS, or 36RS. Load Height for all 5M and 5MP casters — 6.09" ± .06" (155 ± 1.5mm). Load Height for 4LD caster — 4.62" ± .06" (118 ± 1.5mm). Load Height for 5LD caster — 5.06" ± .06" (143 ± 1.5mm). Brakes are foot-operated.

Plated Stem Casters

Use with Super Erecta posts and shelves (see pages 42 and 43) to create a mobile shelving unit to meet your special needs. Stem casters are shipped with donut bumper at no additional charge.



Donut Bumper

Donut Bumpers — {11.40}

- Non-phthalate, flexible vinyl material

Diameter (in.)	Diameter (mm)	Height (in.)	Height (mm)	Weight (lbs.)	Weight (kg)	Cat. No.	Each
3.5	89	.75	19	.19	8.6	9992DB*	9.40
5.5	140	.81	21	.21	9.5	9992N	14.60

*Included with each Super Erecta stem caster as noted on previous page.

Low Profile 3" Casters — {11.20}

Ideal for creating shorter height mobile units for undercounter use. Threaded stem fits stationary posts with threaded base. (Remove leveling foot and install caster)

Wheel Diameter (in.)	Wheel Diameter (mm)	Face (in.)	Face (mm)	Load Rating (lbs.)	Load Rating (kg)	Type	Wheel Thread	Temperature Range (Continuous Usage)		Cat. No.
								(Fahrenheit)	(Celsius)	
3	76	.94	24	100	45	Threaded Stem, Swivel	Resilient Rubber	-30° - 160°	-34° - 71°	3TM
3	76	.94	24	100	45	Threaded Stem, Swivel/Brake	Resilient Rubber	-30° - 160°	-34° - 71°	3TMB

Note 1: Not intended for carts that travel long distances.



3TM



3TMB

Decorative Casters — {10.06}

- Black nylon housing with non-marking polymer tread.
- 2.5" (63mm) models have threaded stem and attach to stationary shelving posts.
- 4" (100mm) casters include threaded insert for use with mobile posts.

Type	Diameter (in.)	Diameter (mm)	Fits Post Type	Cat. No.
Swivel/Brake	2.5	63	Stationary	HDC3BB
Swivel	4	100	Mobile	HDC5B
Swivel/Brake	4	100	Mobile	HDC5BB

Castors shipped with post inserts for adaptability to mobile posts.



HDC5B

HDC5BB

Wheel Material? What's the difference?

Wheel Material	Oil & Grease Resistance	Rollability	Noise
Resilient Rubber	LOW	FAIR	LOW
Neoprene	HIGH	GOOD	LOW
Polyurethane	HIGH	GOOD	MODERATE
High-Modulus Rubber	HIGH	GOOD	LOW
Conductive	LOW	FAIR	LOW



SUPER ERECTA® STEM CASTERS

Casters for Wet or Corrosive Areas



BETTER

Polymer Stem Casters — {11.20}

Basic rust resistant - nylon and Polyurethane wheel tread.
 • Harder tread for maneuvering of heavier loads.



5PC 5PCB

Wheel Diameter (in.) (mm)	Face (in.) (mm)	Load Rating (lbs.) (kg)	Type	Wheel Tread	Temperature Range (Continuous Usage)		Cat. No.	Cat. No. Antimicrobial
					(Fahrenheit)	(Celsius)		
5 127	1.25 32	300 135	Stem/Swivel	Polyurethane, Flat	-20°-120°	-29°-49°	5PC	5PCM
5 127	1.25 32	300 135	Stem/Brake	Polyurethane, Flat	-20°-120°	-29°-49°	5PCB	5PCBM
5 127	1.25 32	300 135	Stem/Rigid	Polyurethane, Flat	-20°-120°	-29°-49°	5PCR	

Note 1: Rigid casters are held in place by a connecting channel. When ordering, shelf width must be provided. Rigid connecting channel (aluminum) for 5PCR casters: Cat. No. P14RC, P18RC, P21RC, P24RC, P30RC, or P36RC. **Not suitable for cart wash and autoclave applications.**

BEST

Stainless Steel Cart-Washable Stem Casters — {11.20}

Type 304 Stainless rigs for intense cleaning and sterilization protocols.
 • Best chemical resistance
 • Best for high temperature cart wash chambers.
 • Best for high impact mobile uses.

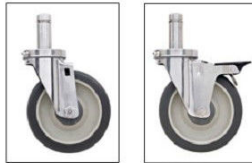

5MPGSA 5MPBGA



5MHTN 5MHTNB

Wheel Diameter (in.) (mm)	Face (in.) (mm)	Load Rating (lbs.) (kg)	Type	Wheel Tread	Temperature Range (Continuous Usage)		Cat. No.
					(Fahrenheit)	(Celsius)	
5 127	1.25 32	250 113	Stem/Swivel	High Modulus Donut	-20°-180°	-29°-82°	5MDGSA
5 127	1.25 32	250 113	Stem/Brake	High Modulus Donut	-20°-180°	-29°-82°	5MDBGSA
5 127	1.25 32	250 113	Stem/Rigid	High Modulus Donut	-20°-180°	-29°-82°	5MDRGSA
5 127	1.25 32	300 135	Stem/Swivel	Polyurethane, Flat	-20°-180°	-29°-82°	5MPGSA
5 127	1.25 32	300 135	Stem/Brake	Polyurethane, Flat	-20°-180°	-29°-82°	5MPBGSA
5 127	1.25 32	300 135	Stem/Rigid	Polyurethane, Flat	-20°-180°	-29°-82°	5MPRGSA

Note: Rigid casters are held in place by a connecting channel. When ordering, shelf width must be provided. Rigid connecting channel (stainless steel): Cat. No. 14HS, 18HS, 21HS, 24HS, 30HS, or 36HS. Load Height for all 5MD and 5MP casters — 6.09" ± .06" (155 ± 1.5mm). All casters are grease sealed with zerk fittings in swivel and axle. Brakes are foot-operated.

High-temperature Autoclave Stem Casters

Wheel Diameter (in.) (mm)	Face (in.) (mm)	Load Rating (lbs.) (kg)	Type	Wheel Tread	Temperature Range (Continuous Usage)		Cat. No.
					(Fahrenheit)	(Celsius)	
5 127	1.5 38	300 135	Stem/Swivel	Nylon, Flat	-20°-475°	-29°-250°	5MHTN
5 127	1.5 38	300 135	Stem/Brake	Nylon, Flat	-20°-475°	-29°-250°	5MHTNB

Swaged Posts — For cart wash and autoclave applications

Type 304 stainless post has an aluminum cap swaged into the post top. For use with standard stem casters.



Swaged Post

Description	Dimensions		Cat. No.
	(in.)	(mm)	
Stem Caster Post	33	875	33UPS-SW
Stem Caster Post	54	1370	54UPS-SW
Stem Caster Post	63	1600	63UPS-SW

Note: For special height posts, please consult your Metro representative.



CASTER INSTALLATION

SUPER ERECTA® CART DOLLIES



Made-to-Order Truck Dollies — {11.37}

Select the desired dolly size from the chart below and combine with the desired plate casters found on page 61. The caster plate style must be specified at the time of order — “B” or “C” plate. The dollies are modified at the factory prior to shipment. For example, D2448NCB, four B5P = one aluminum dolly frame with four 5” B-plate swivel polyurethane casters designed to accommodate nominal 24” x 48” (610 x 1219mm) shelves.



Dolly Frame

Metro Fact:

Metro dolly frames and stock truck dollies add 3.12” (78mm) to the length of the unit and 3.37” (87mm) to the unit width.

Stainless steel frames and staked posts are recommended for heavy-duty applications.

Truck Dolly Frames

Shelf Width/Length (in.)	Shelf Width/Length (mm)	ALUMINUM		STAINLESS	
		Cat. No. with Corner Bumper	Cat. No. with Wraparound Bumper	Cat. No. with Corner Bumper	Cat. No. with Wraparound Bumper
18x24	457x610	D1824NCB	D1824NP	D1824SCB	D1824SP
18x30	457x760	D1830NCB	D1830NP	D1830SCB	D1830SP
18x36	457x914	D1836NCB	D1836NP	D1836SCB	D1836SP
18x42	457x1066	D1842NCB	D1842NP	D1842SCB	D1842SP
18x48	457x1219	D1848NCB	D1848NP	D1848SCB	D1848SP
18x60	457x1524	D1860NCB	D1860NP	D1860SCB	D1860SP
18x72	457x1825	D1872NCB	D1872NP	D1872SCB	D1872SP
21x24	530x610	D2124NCB	D2124NP	D2124SCB	D2124SP
21x30	530x760	D2130NCB	D2130NP	D2130SCB	D2130SP
21x36	530x914	D2136NCB	D2136NP	D2136SCB	D2136SP
21x42	530x1066	D2142NCB	D2142NP	D2142SCB	D2142SP
21x48	530x1219	D2148NCB	D2148NP	D2148SCB	D2148SP
21x60	530x1524	D2160NCB	D2160NP	D2160SCB	D2160SP
21x72	530x1825	D2172NCB	D2172NP	D2172SCB	D2172SP
24x24	610x610	D2424NCB	D2424NP	D2424SCB	D2424SP
24x30	610x760	D2430NCB	D2430NP	D2430SCB	D2430SP
24x36	610x914	D2436NCB	D2436NP	D2436SCB	D2436SP
24x42	610x1066	D2442NCB	D2442NP	D2442SCB	D2442SP
24x48	610x1219	D2448NCB	D2448NP	D2448SCB	D2448SP
24x60	610x1524	D2460NCB	D2460NP	D2460SCB	D2460SP
24x72	610x1825	D2472NCB	D2472NP	D2472SCB	D2472SP

Note 1: “Made To Order Dollies” are non-returnable and orders are non-cancelable.
Note 2: Replacement wraparound bumper kits are available. See your Metro representative for details.
Note 3: Maximum load capacity for dollies is 1,000 lbs. (454kg), depending on caster selection.

Stock Truck Dollies — {11.36}

These are aluminum dollies with a single catalog number for frame and casters with wraparound bumper. Use with Super Erecta Shelving and posts to create mobile carts for higher weight capacities. See specific plate caster load ratings (page 61) to determine appropriate stock truck dolly.



Stock Dolly

Shelf Width/Length (in.)	Shelf Width/Length (mm)	Castors	Cat. No.
24x36	610x914	Two B5DN/Two B5DNB	D53JN
24x48	610x1219	Two B5DN/Two B5DNB	D55JN
24x60	610x1524	Two B5DN/Two B5DNB	D56JN
24x36	610x914	Two 6P/Two BL6P	D53MN
24x48	610x1219	Two 6P/Two BL6P	D55MN
24x60	610x1524	Two 6P/Two BL6P	D56MN
24x48	610x1219	Two 8P/Two BL8P	D55PN
24x60	610x1524	Two 8P/Two BL8P	D56PN
24x48	610x1219	Two C8DA/Two C8DSL*	D55PSLN
24x60	610x1524	Two C8DA/Two C8DSL*	D56PSLN

*Swivel Lock.
Note: Replacement wraparound bumper kits are available. See your Metro representative for details.

Staked Posts — For use with Truck Dollies — {10.01}

Each post connects to a truck dolly through the stem receptacle. The stem receptacles are staked into the bottom of these posts to ensure a durable connection in abusive applications.



Staked Post

Height* (in.)	Height* (mm)	Approx. Pkd. Wt. (lbs.) (kg)	Cat. No. Chrome	Cat. No. Stainless
54.56	1385	3 1.4	54P-STKD	54PS-STKD
62.56	1590	3.5 1.6	63P-STKD	63PS-STKD
74.62	1895	4 1.8	74P-STKD	74PS-STKD

*Height includes leveling bolt and cap.

Pitched Aluminum Dust Cover — {11.37}

For “Made-To-Order” dollies, these covers act as a barrier between the floor and the bottom shelf of cart for cleanliness. These covers are factory-assembled and must be ordered with desired dolly frame.

Width/Length (in.)	Width/Length (mm)	Approx. Pkd. Wt. (lbs.) (kg)	Cat. No.
24x36	610x914	7 3.2	DCT2436N
24x42	610x1066	7 3.2	DCT2442N
24x48	610x1219	8 3.6	DCT2448N
24x60	610x1524	8 3.6	DCT2460N
24x72	610x1825	8 3.6	DCT2472N

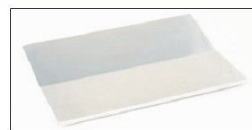

Pitched Aluminum Dust Cover



SUPER ERECTA® PLATE CASTERS

Plate Casters — {11.37}

Use in conjunction with Metro "Made-to-Order" truck dollies to assemble a heavy-duty mobile base for your needs. Important: The caster plate style must be specified at the time of order — "B" or "C" plate. The dollies are modified at the factory prior to shipment.

Top view of caster plates

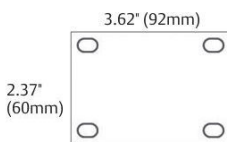

B-plate casters offer good impact resistance for common thresholds.

4.75" (121mm)

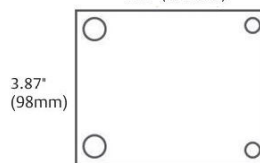

C-plate casters offer the thickest metal chassis and largest wheels for the most abusive conditions and heaviest storage loads.

Diameter (in.)	Wheel Face (mm)	Load Rating (lbs.)	Load Rating (kg)	Weight Each (lbs.)	Weight Each (kg)	Type	Wheel Tread	Cat. No.		
5	125	1.37	35	225	101	2.12	.99	Swivel	Donut Neoprene	B5DN
5	125	1.37	35	225	101	2.25	1	Brake	Donut Neoprene	B5DNB
5	125	1.37	35	225	101	2	.9	Rigid	Donut Neoprene	B5DNR
5	125	1.75	31	300	135	2.12	.99	Swivel	Polyurethane	B5P
5	125	1.75	31	300	135	2.25	1	Brake	Polyurethane	B5PB
5	125	1.75	31	300	135	2	.9	Rigid	Polyurethane	B5PR
6	152	2	51	400	181	8	3.63	Swivel	Hi-Modulus Donut	C6DA
6	152	2	51	400	181	8	3.63	Swivel/Brake	Hi-Modulus Donut	C6DBA
6	152	2	51	400	181	8	3.63	Rigid	Hi-Modulus Donut	C6DRA
6	152	2	51	400	181	8	3.63	Swivel/Lock	Hi-Modulus Donut	C6DSL
8	203	2	51	450	204	9	4.08	Swivel	Hi-Modulus Donut	C8DA
8	203	2	51	450	204	9	4.08	Swivel/Brake	Hi-Modulus Donut	C8DBA
8	203	2	51	450	204	9	4.08	Rigid	Hi-Modulus Donut	C8DRA
8	203	2	51	450	204	9	4.08	Swivel/Lock	Hi-Modulus Donut	C8DSL
6	150	2	51	500	225	4.75	2.1	Swivel	Polyurethane	C6P
6	150	2	51	500	225	4.87	2.2	Brake	Polyurethane	C6PB
6	150	2	51	500	225	3.5	1.6	Rigid	Polyurethane	C6PR
6	150	2	51	500	225	5	2.3	Swivel/Lock	Polyurethane	C6PS/L-LH
8	200	2	51	700	315	5.75	2.6	Swivel	Polyurethane	C8P
8	200	2	51	700	315	5.87	2.65	Brake	Polyurethane	C8PB
8	200	2	51	700	315	4.5	2	Rigid	Polyurethane	C8PR
8	200	2	51	700	315	6	2.7	Swivel/Lock	Polyurethane	C8PS/L-LH
8	200	2	51	280	127	8	3.6	Swivel	Semi-Pneumatic Style	C8SPN
8	200	2	51	280	127	8.5	3.8	Swivel/Brake	Semi-Pneumatic Style	C8SPNB
8	200	2	51	280	128	8	3.6	Rigid	Semi-Pneumatic Style	C8SPNR

Note 1: Brakes are foot-operated.
Note 2: 8" (200mm) casters should not be used on units less than 21" (530mm) wide.
Note 3: Swivel lock casters are set diagonally on the left-hand sides when dolly mounted.
Load Heights: (± .06") (± 1.6mm) B5 Series — 6.25" (159mm), C6 Series — 7.50" (190mm), C8 Series — 9.50" (241mm), 8S Series — 9.50" (241mm)



B5DNB B5PB



C6DBA C6PB



C8SPN Semi-Pneumatic "Flat-Free" C8PB



B5PGSA B6PGSA

Stainless Steel Cart-Washable Plate Casters — {11.37}

Wheel Diameter (in.)	Face (mm)	Load Rating (lbs.)	Load Rating (kg)	Weight Each (lbs.)	Weight Each (kg)	Type	Wheel Tread	Cat. No.		
5	125	1.25	31	300	135	2.12	.99	Swivel	Polyurethane	B5PGSA
5	125	1.25	31	300	135	2.25	1	Brake	Polyurethane	B5BPGSA
5	125	1.25	31	300	135	2	.9	Rigid	Polyurethane	B5PRGSA
6	150	1.5	38	600	270	4.75	2.1	Swivel	Polyurethane	C6PGSA
6	150	1.5	38	600	270	4.87	2.2	Brake	Polyurethane	C6BPGSA

See above notes for important specification information.

Caster Information & Tips. See specification sheet for details. — {11.37}

- How to configure you caster selections for maneuverability
- Over-the-road application guidelines
- Replacement casters & hardware

See page 58 for additional specifications and appropriate parameters for all types of Metro casters.

NOTE: See spec sheet 11.37 for images of each caster option.

SUPER ERECTA® TRUCK CASTERS & ACCESSORIES



Brake Lock/Swivel Lock Combination Casters — {11.37}

Patented, foot-operated design enables a single pair of casters to serve as swivel, rigid or brake casters. Conveniently positioned on the dolly, not on the wheels, the downward pressure pedals prevent scuffing of shoes.

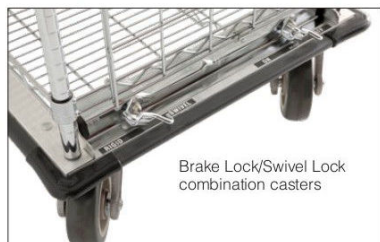

- **Convenient.** Pedals are on the dolly, not the wheels, making operation more convenient. Downward pressure on the pedals save shoes from scuffing.
- **Casters.** Long wearing polyurethane. Resists abrasion. Non-marking, shock absorbing. Wheels are available in 6" (152mm) and 8" (203mm) size.
- **Recommended Caster Selection.** Two swivel casters at one end and brake/swivel lock set at the other end. Other caster combinations can be used, however, including brake/swivel lock sets at both ends. Wraparound bumper recommended.

Note: Aluminum dust covers and tow bar assemblies are not compatible with the Brake Lock/Swivel Lock Combination casters.



When "Rigid" is engaged the swivel casters will lock into the trailing position for easy steering of heavy loads over long distances. When "Swivel" is engaged the caster set swivels freely for easier maneuvering.



When the "Brake" pedal is engaged both of the BL casters are locked. The cart remains still for loading and unloading.

Type	Wheel Diameter (in.) (mm)	Face (in.) (mm)	For Use With	Load Rating (lbs.) (kg)	Weight (lbs.) (kg)	Cat. No.
*Brake/Lock	6 152	2 51	24" (610mm) Deep Dolly and 6P Caster	600 272	7 ¹ / ₄ 3.3	BL6P24
*Brake/Lock	8 203	2 51	24" (610mm) Deep Dolly and 8P Caster	600 272	9 4.1	BL8P24
Swivel	6 152	2 51	BL6P24 Brake/Lock Set	600 272	5 ¹ / ₄ 2.3	6P
Rigid	6 152	2 51	6P Swivel Caster	600 272	5 2.26	6PR
Swivel	8 203	2 51	BL8P24 Brake/Lock Set	600 272	6 ¹ / ₂ 2.9	8P
Rigid	8 203	2 51	8P Swivel Caster	600 272	6 2.7	8PR

Load Heights: (±¹/₁₆") (± 1.6mm) 6P Series — 7⁷/₈" (200mm), 8P Series — 9¹³/₁₆" (249mm).



Push Handle



Extended Handle

Handles — {11.40}

Use on corresponding width Super Erecta units to provide additional maneuverability to dolly carts or stem caster carts. Aluminum split sleeves included for attaching to cart.

Length (in.) (mm)	Push Handles		Extended Handles	
	Cat. No. Chrome	Cat. No. Stainless	Cat. No. Chrome	Cat. No. Stainless
14 355	PH14NC	PH14NS	EH14NC	EH14NS
18 457	PH18NC	PH18NS	EH18NC	EH18NS
21 530	PH21NC	PH21NS	EH21NC	EH21NS
24 610	PH24NC	PH24NS	EH24NC	EH24NS
30 760	PH30NC		EH30NC	
36 914	PH36NC		EH36NC	

Note: Handles fit unit widths only. Extended handles add 6" (152.4mm) to length of unit.



SUPER ERECTA® SHELVING ACCESSORIES



Tow Bar Assembly

Tow Bar Assembly — {11.37}

Attaches to underside of dolly to facilitate transport of dolly carts in tandem. Must be factory assembled and ordered with desired dolly frame (see page 60).

Length		Cat. No.
(in.)	(mm)	
48	1219	TBA48

Note: "C" plate caster must be used with Tow Bar Assembly. Tow Bar Assembly for use with 24" (610mm) units only.

Note: Number of carts to be towed, weight on carts, and towing route affect operation of tow bar assembly. **Before ordering, contact your Metro representative.**

Tow Bar Assembly not appropriate for use with Brake Lock/Swivel Lock system.

Foot Plates — {10.06}

Use to bolt units to the floor, or when a broader, more stable foot is desired. Zinc. Cat. No. 9993Z
Stainless Steel. Cat. No. 9993S
Black. Cat. No. 9993BL



Aluminum Split Sleeves — {10.06}

For high temperature, over the road, or conductive applications. Zinc or stainless steel retainer rings available to secure shelf. One bag required per shelf; 4 pairs per bag.



	Cat. No.
Aluminum Split Sleeves with Zinc Rings	9986Z
Aluminum Split Sleeves with Stainless Rings	9986S

Glides — {10.06}

Smooth polymer cover fits over leveling bolt to protect floors. Cat. No. 9991P



Decorative Leveling Foot — {10.06}

Decorative alternative for post. Compensates for uneven surfaces. Chrome. Cat. No. HDFC
Black. Cat. No. HDFB



Replacement Plastic Split Sleeves — {10.06}

One bag required per shelf; 4 pairs per bag.



Black Split Sleeve



White Split Sleeve

	Cat. No.
Black Plastic Split Sleeves	9985
White Plastic Split Sleeves	9985W

Note: White post caps and white split sleeves are standard with white designer shelving only.

Wall Clamp — {10.06}

Use to secure a stationary unit to the wall for greater stability. Plated finish. Compatible with Super Erecta wire shelves and Super Adjustable Super Erecta wire shelves. Cat. No. 9984C



Post Clamps — {10.06}

Joins units together for maximum strength. Zinc-plated. Cat. No. 9994Z
Black. Cat. No. 9994BL



Replacement Super Adjustable Kit — {10.06}

Package includes 4 wedges, 4 sleeves, and 4 corner releases. Cat. No. SAKITA2





Dividers



Shelf Divider for Super Erecta Shelves

Shelf Dividers for Super Erecta Shelves — {10.04}

Keep shelf contents orderly with these 8" (203mm) high, pressure-fit dividers.

Shelf Width (in.) (mm)	Cat. No. Plated	Cat. No. Black	Cat. No. White	Cat. No. Smoked Glass
14 355	DD14C	DD14BL	DD14W	DD14-DSG
18 457	DD18C	DD18BL	DD18W	DD18-DSG
21 530	DD21C	DD21BL	DD21W	DD21-DSG
24 610	DD24C	DD24BL	DD24W	DD24-DSG
30 760	DD30C	DD30BL	DD30W	DD30-DSG
36 914	DD36C	DD36BL	DD36W	DD36-DSG

Shelf Width (in.) (mm)	Cat. No. Metroseal Gray with Microban®	Cat. No. Metroseal Green with Microban®	Cat. No. Stainless	Cat. No. Copper Hammertone
14 355	DD14K4	DD14K3	DD14S	DD14-DCH
18 457	DD18K4	DD18K3	DD18S	DD18-DCH
21 530	DD21K4	DD21K3	DD21S	DD21-DCH
24 610	DD24K4	DD24K3	DD24S	DD24-DCH
30 760	-	DD30K3	DD30S	-
36 914	-	-	DD36S	-

Select quick-mount dividers for light-duty applications

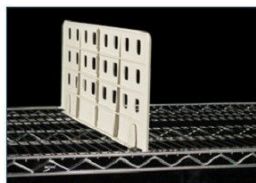

8" Universal Shelf Divider

Universal 8" (203mm) Shelf Dividers — Light Duty — {9.25}

Each divider includes a panel and two clips to connect to any Super Erecta or Super Adjustable wire self. Corrosion proof.

Nominal Length (in.) (mm)	Fits Shelf Depth	Cat. No.
18 457	18", 21" (457, 530mm)	MUD18-8
24 610	24" (610mm)	MUD24-8



SUPER ERECTA® SHELVING ACCESSORIES

Tall dividers contain larger items and create more defined compartments.

21" Tall Divider
 Chrome finish.
 Fits 24" Deep Shelf
 Cat. No. **DD24C-21H**

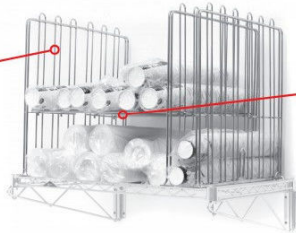

Horizontal Divider
 Chrome finish.
 Fits 21" Tall Divider
 Available in 12" or 18" lengths
 Cat. No. **DDH24C-12L**
 Cat. No. **DDH24C-18L**

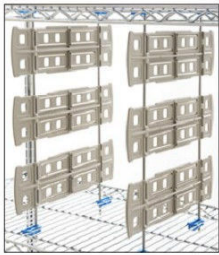

Shelf-to-Shelf Dividers

Shelf-to-Shelf Dividers — {9.25}

Full height dividers efficiently compartmentalize the space between two shelves. Corrosion proof. Compatible with Super Erecta and Super Adjustable wire shelves.

Fits Shelf Depth		Nominal Height		Cat. No.
(in.)	(mm)	(in.)	(mm)	
18, 21	457, 530	16	406	MD18-16
18, 21	457, 530	20	508	MD18-20
18, 21	457, 530	24	610	MD18-24
24	610	16	406	MD24-16
24	610	20	508	MD24-20
24	610	24	610	MD24-24

*Note: -16 parts have three panels, -20 parts have four panels, -24 parts have five panels.

Divide shelf space with rods to sort hard to manage items.



RODS & TABS INSTALLATION

Rods and Tabs — {10.04}

Form side and back enclosures for a shelving unit. Can also serve as uniform dividers within unit by passing through shelves from top to bottom. Recommended spacing: every 6" (150mm) to 12" (305mm), depending upon shelf contents. Plated rods are shipped with 4 plated tabs per rod. Stainless steel rods come with 4 rust-proof tabs.

Min. Post Height (in.)	Rod Length (in)	Rod Length (mm)	Approx. Pkd. Wt. (lbs.)	Approx. Pkd. Wt. (kg)	Cat. No. Plated	Cat. No. Stainless
54	52	1320	1	0.5	R52C	R52S
63	61	1549	1	0.5	R61C	R61S
74	72	1830	1.25	0.6	R72C	R72S
86	84	2135	1.5	0.7	R84C	R84S



Stainless Steel rod with rust-proof tab.

Additional Rust-Proof Tabs —
 Bag of 4
 Cat. No. **9084P**



Plated rod with plated tab.

Additional Plated Tabs —
 Bag of 12
 Cat. No. **9084Z**

SUPER ERECTA® SHELVING ACCESSORIES



Ledges, frames & enclosures.

Shelf Ledges — Side and Back — {10.04}

For stationary or mobile installations, ledges prevent items from protruding or falling from shelves.

1" (25mm) High Ledges

Approx. Shelf Width (in.)	Approx. Shelf Width (mm)	Cat. No. Plated	Cat. No. Black	Cat. No. White	Cat. No. Smoked Glass	Cat. No. Metroseal Green with Microban*	Cat. No. Metroseal Gray with Microban*	Cat. No. Stainless	Cat. No. Copper Hammerstone
14	355	L14N-1C	L14N-1BL	L14N-1W	L14N-1-DSG	-	-	L14N-1S	L14N-1-DCH
18	457	L18N-1C	L18N-1BL	L18N-1W	L18N-1-DSG	-	-	L18N-1S	L18N-1-DCH
21	530	L21N-1C	L21N-1BL	L21N-1W	L21N-1-DSG	-	-	L21N-1S	L21N-1-DCH
24	610	L24N-1C	L24N-1BL	L24N-1W	L24N-1-DSG	-	-	L24N-1S	L24N-1-DCH
30	760	L30N-1C	L30N-1BL	L30N-1W	L30N-1-DSG	-	-	L30N-1S	L30N-1-DCH
36	914	L36N-1C	L36N-1BL	L36N-1W	L36N-1-DSG	-	-	L36N-1S	L36N-1-DCH
42	1066	L42N-1C	L42N-1BL	L42N-1W	L42N-1-DSG	-	-	L42N-1S	L42N-1-DCH
48	1219	L48N-1C	L48N-1BL	L48N-1W	L48N-1-DSG	-	-	L48N-1S	L48N-1-DCH
54	1370	L54N-1C	L54N-1BL	L54N-1W	L54N-1-DSG	-	-	L54N-1S	L54N-1-DCH
60	1524	L60N-1C	L60N-1BL	L60N-1W	L60N-1-DSG	-	-	L60N-1S	L60N-1-DCH
72	1828	L72N-1C	L72N-1BL	L72N-1W	L72N-1-DSG	-	-	L72N-1S	L72N-1-DCH

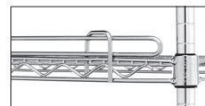

1" (25mm) Ledge

4" (100mm) High Stackable Ledges

Approx. Shelf Width (in.)	Approx. Shelf Width (mm)	Cat. No. Plated	Cat. No. Black	Cat. No. White	Cat. No. Smoked Glass	Cat. No. Metroseal Green with Microban*	Cat. No. Metroseal Gray with Microban*	Cat. No. Stainless	Cat. No. Copper Hammerstone
14	355	L14N-4C	L14N-4BL	L14N-4W	L14N-4-DSG	L14N-4K3	L14N-4K4	L14N-4S	L14N-4-DCH
18	457	L18N-4C	L18N-4BL	L18N-4W	L18N-4-DSG	L18N-4K3	L18N-4K4	L18N-4S	L18N-4-DCH
21	530	L21N-4C	L21N-4BL	L21N-4W	L21N-4-DSG	L21N-4K3	L21N-4K4	L21N-4S	L21N-4-DCH
24	610	L24N-4C	L24N-4BL	L24N-4W	L24N-4-DSG	L24N-4K3	L24N-4K4	L24N-4S	L24N-4-DCH
30	760	L30N-4C	L30N-4BL	L30N-4W	L30N-4-DSG	L30N-4K3	L30N-4K4	L30N-4S	L30N-4-DCH
36	914	L36N-4C	L36N-4BL	L36N-4W	L36N-4-DSG	L36N-4K3	L36N-4K4	L36N-4S	L36N-4-DCH
42	1066	L42N-4C	L42N-4BL	L42N-4W	L42N-4-DSG	L42N-4K3	L42N-4K4	L42N-4S	L42N-4-DCH
48	1219	L48N-4C	L48N-4BL	L48N-4W	L48N-4-DSG	L48N-4K3	L48N-4K4	L48N-4S	L48N-4-DCH
54	1370	L54N-4C	L54N-4BL	L54N-4W	L54N-4-DSG	L54N-4K3	L54N-4K4	L54N-4S	L54N-4-DCH
60	1524	L60N-4C	L60N-4BL	L60N-4W	L60N-4-DSG	L60N-4K3	L60N-4K4	L60N-4S	L60N-4-DCH
72	1828	L72N-4C	L72N-4BL	L72N-4W	L72N-4-DSG	L72N-4K3	L72N-4K4	L72N-4S	L72N-4-DCH



4" (102mm) Ledge

Note: Actual ledge length is approximately 1" (25mm) shorter than nominal shelf length/width.

Three-Sided Double Snake Frames — {10.04}

Provide additional support or access to floor with these sturdy three-sided double snake frames. Chrome plated, Metroseal Green and Type 304 Stainless steel options.



Three-sided Double Snake Frame

Nominal Width/Length		Cat. No. Chrome	Cat. No. Metroseal Green with Microban*	Cat. No. Stainless	Nominal Width/Length		Cat. No. Chrome	Cat. No. Metroseal Green with Microban*	Cat. No. Stainless
(in.)	(mm)				(in.)	(mm)			
18x24	457x610	SF31N3C	SF31N3K3	-	24x24	610x610	SF51N3C	SF51N3K3	-
18x30	457x760	SF32N3C	SF32N3K3	-	24x30	610x760	SF52N3C	SF52N3K3	-
18x36	457x914	SF33N3C	SF33N3K3	SF33N3S	24x36	610x914	SF53N3C	SF53N3K3	SF53N3S
18x42	457x1066	SF34N3C	SF34N3K3	-	24x42	610x1066	SF54N3C	SF54N3K3	-
18x48	457x1219	SF35N3C	SF35N3K3	SF35N3S	24x48	610x1219	SF55N3C	SF55N3K3	SF55N3S
18x54	457x1372	SF1854N3C	SF1854N3K3	-	24x54	610x1372	SF2454N3C	SF2454N3K3	-
18x60	457x1524	SF36N3C	SF36N3K3	-	24x60	610x1524	SF56N3C	SF56N3K3	SF56N3S
18x72	457x1829	SF37N3C	SF37N3K3	-	24x72	610x1829	SF57N3C	SF57N3K3	SF57N3S

Note: Consult your Metro representative for other sizes.

Note: Consult your Metro representative for other sizes.



SUPER ERECTA® SHELVING ACCESSORIES

Enclosure Panels — {10.04} {10.30}

An efficient way to enclose space for stationary or mobile applications.

- Can be used with Super Erecta and Super Adjustable wire shelving, and Super Erecta solid shelving.
- Appropriate mounting hardware supplied with each panel for stationary applications.



Enclosure Panel

Width/Height (in.)	Width/Height (mm)	For Nominal Post Height (in.)	For Nominal Post Height (mm)	Grid Opening (in.)	Grid Opening (mm)	Weight (lbs.) (kg)	Cat. No. Chrome	Cat. No. Metroseal Gray	Cat. No. Stainless
12.37x50.75	313x1289	54	1370	2.87x3.62	73x92	3 1.4	EP35C	EP35K4	EP35S
12.37x59.75	313x1518	63	1600	2.87x3.62	73x92	4 1.8	EP36C	EP36K4	EP36S
12.37x70.5	313x1791	74	1880	2.87x3.62	73x92	6 2.7	EP37C	EP37K4	EP37S
18.37x50.75	464x1289	54	1370	3.37x3.62	86x92	5 2.3	EP55C	EP55K4	EP55S
18.37x59.75	464x1518	63	1600	3.37x3.62	86x92	6 2.7	EP56C	EP56K4	EP56S
18.37x70.5	464x1791	74	1800	3.37x3.62	86x92	7 3.2	EP57C	EP57K4	EP57S

Note: All panels are .87" (22mm) deep. Units with a solid shelf in the top position require the use of a three-sided double snake frame directly below it (see page 66).

Ordering Guide for Super Erecta Enclosure Panels

Ends — Panels required for each end according to shelf width, as follows:

Nominal Post Height (in.) (mm)	18" (457mm) Nominal Shelf Width	21" (530mm) Nominal Shelf Width	24" (610mm) Nominal Shelf Width	30" (760mm) Nominal Shelf Width	36" (914mm) Nominal Shelf Width
54 1370	(1) EP35	(1) EP35	(1) EP55	(2) EP35	(1) EP35 (1) EP55
63 1600	(1) EP36	(1) EP36	(1) EP56	(2) EP36	(1) EP36 (1) EP56
74 1880	(1) EP37	(1) EP37	(1) EP57	(2) EP37	(1) EP37 (1) EP57

Backs for wire shelves— Requires multiple panels in quantities shown for specific length shelf:

Nominal Post Height (in.) (mm)	30" (760mm) Nominal Shelf Length	36" (914mm) Nominal Shelf Length	42" (1066mm) Nominal Shelf Length	48" (1219mm) Nominal Shelf Length	54" (1370mm) Nominal Shelf Length	60" (1524mm) Nominal Shelf Length	72" (1825mm) Nominal Shelf Length
54 1370	(2) EP35	(1) EP35 (1) EP55	(2) EP55	(2) EP35 (1) EP55	(1) EP35 (2) EP55	(3) EP55	(1) EP35 (3) EP55
63 1600	(2) EP36	(1) EP36 (1) EP56	(2) EP56	(2) EP36 (1) EP56	(1) EP36 (2) EP56	(3) EP56	(1) EP36 (3) EP56
74 1880	(2) EP37	(1) EP37 (1) EP57	(2) EP57	(2) EP37 (1) EP57	(1) EP37 (2) EP57	(3) EP57	(1) EP37 (3) EP57

Backs for solid* shelves— Requires multiple panels in quantities shown for specific length shelf:

Nominal Post Height (in.) (mm)	30" (760mm) Nominal Shelf Length	36" (914mm) Nominal Shelf Length	42" (1066mm) Nominal Shelf Length	48" (1219mm) Nominal Shelf Length	54" (1370mm) Nominal Shelf Length	60" (1524mm) Nominal Shelf Length	72" (1825mm) Nominal Shelf Length
54 1370	(1) EP55	(2) EP35	(1) EP35 (1) EP55	(2) EP55	N/A	(1) EP35	N/A
63 1600	(1) EP56	(2) EP36	(1) EP36 (1) EP56	(2) EP56	N/A	(1) EP36	N/A
74 1880	(1) EP57	(2) EP37	(2) EP37 (1) EP57	(2) EP57	N/A	(1) EP37	N/A

*Note: Units with a solid shelf in the top position require the use of a three-sided double snake frame directly below it (see page 66).



Super Adjustable
Super Erecta Cart with
Enclosure Panels



8 included
per kit



Hardware Kit for Mobile Applications

Additional clamp assemblies are recommended to secure the enclosure panels to the intermediate shelves on a mobile unit or transport cart. For demanding mobile applications, use two clamp assemblies at each intermediate shelf level for each enclosure panel.

Plated steel. **Cat. No. 9970Z** (Kit of 8 clamp assemblies)
Stainless steel. **Cat. No. 9970S** (Kit of 8 clamp assemblies)



x2 x2
Mounting Kit for Enclosure Panel

Replacement Mounting Kit for Enclosure Panel

Kit includes two security S-hooks and two clamp assemblies.

Plated steel. **Cat. No. 9970EPZ**
Stainless steel. **Cat. No. 9970EPS**

SUPER ERECTA® SHELVING ACCESSORIES



Shelf Markers & Label Holders

Color Shelf Marker — {10.05}

Color code for effective organization. Snaps securely to the front edge of Super Erecta and Super Adjustable Super Erecta Wire Shelving.

Shelf Marker Size				Shelf Marker Size			
Marker Size (in.)	Marker Size (mm)	Color	Cat. No.	Marker Size (in.)	Marker Size (mm)	Color	Cat. No.
6x1.25	152x32	Blue	CSM6-B	6x1.25	152x32	White	CSM6-W
6x1.25	152x32	Green	CSM6-G	6x1.25	152x32	Yellow	CSM6-Y
6x1.25	152x32	Red	CSM6-R	6x1.25	152x32	Gray	CSM6-GR
6x1.25	152x32	Tan	CSM6-T				



Color Shelf Markers



CSM6-B



CSM6-G



CSM6-R



CSM6-T



CSM6-W



CSM6-Y



CSM6-GR

Gray Label Holders — {10.05}

Holds most commercial 1.25" (32mm) labels. Available in a variety of lengths.

Length (in.)	Length (mm)	Fits Shelf Length (in./mm)		Cat. No.
3	75	All		9990P
13	330	18	457	9990P1
19	480	24	610	9990P2
25	635	30	760	9990P30
31	725	36	914	9990P3
43	1090	48	1219	9990P4
55	1395	60	1520	9990P5

For Cantilever Shelves, use 3" (75mm) label holder only.



Gray Label Holder

Clear Label Holders — {10.05}

Allow decorator colors to show through. Holds most commercial 1.25" (32mm) labels.

Length (in.)	Length (mm)	Fits Shelf Length (in./mm)		Cat. No.
3	75	All		9990CL
13	330	18	457	9990CL1
19	480	24	610	9990CL2
25	635	30	760	9990CL30
31	725	36	914	9990CL3
43	1090	48	1219	9990CL4
55	1395	60	1520	9990CL5

For Cantilever Shelves, use 3" (75mm) label holder only.



Clear Label Holder

Slanted Label Holders — {10.05}

Gray solid plastic holder puts 1.25" (32mm) labels on slant for easier viewing.

Length (in.)	Length (mm)	Fits Shelf Length (in./mm)		Cat. No.
3	75	All		9990SL
13	330	18	457	9990SL1
19	480	24	610	9990SL2
25	635	30	760	9990SL30
31	725	36	914	9990SL3
43	1090	48	1219	9990SL4
55	1395	60	1520	9990SL5

For Cantilever Shelves, use 3" (75mm) label holder only.



Slanted Label Holder



SUPER ERECTA® SHELVING ACCESSORIES

Shelf Slides

Tray Slides — {10.04}

- Compatible with Metro tote boxes, Bun/Sheet pans, Hotel Pans (Steam Table Pans)
- Columns can be positioned along the shelf to fit different size vessels.

Width (in./mm)		Overall Depth (in./mm)		Slide Profile (in./mm)		On Center Slide Spacing (in./mm)		Fits Shelf Width (in./mm)		Overall Height (in./mm)		Cat. No. Chrome	Cat. No. Metroseal Green with Microban®
14.62	371	2.25	56	1.50	37	1.50	37	18	457	22.75	578	15SNC	15SNK3
20	508	2.25	56	1.50	37	1.50	37	24	610	22.75	578	20SNC	20SNK3



Tray Slides

Super Erecta Slide System — {10.04}

A super space-saving solution. Using Super Erecta wire units 21" or 24" (530 and 610mm) wide, tote boxes and this innovative slide system, you have the flexibility to create a custom configuration that can be positioned quickly on new or existing units without the use of tools. Finish is nickel-chrome wire with clear protective coating.

Outside Slide Dimensions Height/Width/Length (in./mm)		Fits Shelf Width (in./mm)		Adaptable Boxes	Approx. Pkd. Wt. (lbs./kg)		Cat. No.
10.25x20.38x21.62	256x510x537	24	610	TB/MTB93030 TB/MTB93060 TB/MTB93080	4.75	2.1	SS2NC
10.25x14x17.13	256x355x430	21	530	TB/MTB92035 TB/MTB92060 TB/MTB92080	3.5	1.5	SS3NC
10.25x25.13x17.13	256x630x430	21	530	TB/MTB93030* TB/MTB93060* TB/MTB93080*	4	1.8	SS4NC

*Fits SS4NC with box turned sideways.*Not adaptable to 24" (610mm) long shelf.

See pages 92-93 for tote boxes.

Super Erecta Slide System in place on shelf (Tote box sold separately)

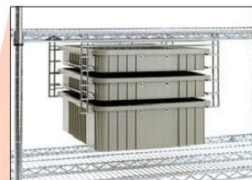



Super Erecta Slide Shelf Spacing Guide

Tote box combinations per slide

13" Shelf Spacing (330mm)

3" (75mm)	3" (75mm)
6" (152mm)	3" (75mm)
	3" (75mm)

16" Shelf Spacing (406mm)

6" (152mm)	3" (75mm)	3" (75mm)
	3" (75mm)	
6" (152mm)	6" (152mm)	8" (203mm)

18" Shelf Spacing (457mm)

6" (152mm)	3" (75mm)
	3" (75mm)
8" (203mm)	8" (203mm)

Adjustable Undershelf Slides — {10.04}

These slides can be spaced to fit any width container or tote box.

Item	Approx. Pkd. Wt. (lbs./kg)		Cat. No. (pair)
For 18" (457mm) wide shelf	1	0.4	US18NA
For 21" (530mm) wide shelf	1	0.4	US21NA
For 24" (610mm) wide shelf	1	0.4	US24NA



Adjustable Undershelf Slide

SUPER ERECTA® SHELVING ACCESSORIES



Decorator Shelf Inlays

Decorator Shelf Inlays — {10.06}

Hardboard mats prevent small items from falling through wire shelves. Fit between posts and level with top of shelf edge. Reversible, black and white. Packed individually.

Width/Length (in.)		Width/Length (mm)		Cat. No.
14x36	355x914			1436BWI
14x48	355x1219			1448BWI
18x24	457x610			1824BWI
18x36	457x914			1836BWI
18x48	457x1219			1848BWI
24x24	610x610			2424BWI
24x36	610x914			2436BWI
24x48	610x1219			2448BWI



Clear Shelf Inlays

Clear Shelf Inlays — {10.06}

Nearly invisible plastic mat retains open-wire look of shelves and allows light penetration. Sold in packages of 4.

Width/Length (in.)		Width/Length (mm)		Cat. No.	Width/Length (in.)		Width/Length (mm)		Cat. No.
14x36	355x914			1436CI-4	21x36	530x914			2136CI-4
14x48	355x1219			1448CI-4	21x48	530x1219			2148CI-4
14x60	355x1524			1460CI-4	21x60	530x1524			2160CI-4
18x36	457x914			1836CI-4	24x36	610x914			2436CI-4
18x48	457x1219			1848CI-4	24x48	610x1219			2448CI-4
18x60	457x1524			1860CI-4	24x60	610x1524			2460CI-4

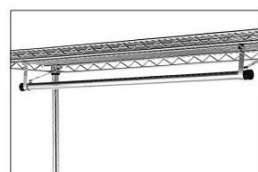

Garment Hanger Tube with Brackets

Garment Hanger Tube with Brackets — {10.05}

Hanger tubes attach easily under Super Erecta shelves for hanging garments. Available in 18," 21" and 24" (457, 530 and 610mm) widths and in same length as shelves.

Tube Length (in.)	Tube Length (mm)	Approx. Pkd. Wt. (lbs.) (kg)		Shelf Width		
				18" (457mm)	21" (530mm)	24" (610mm)
24	610	2.50	1.1	AT2418NC	AT2421NC	AT2424NC
30	760	2.50	1.1	AT3018NC	AT3021NC	AT3024NC
36	914	3	1.4	AT3618NC	AT3621NC	AT3624NC
42	1066	3.50	1.6	AT4218NC	AT4221NC	AT4224NC
48	1219	3.50	1.6	AT4818NC	AT4821NC	AT4824NC
60	1524	4	1.8	AT6018NC	AT6021NC	AT6024NC
72	1828	4.50	2.0	AT7218NC	AT7221NC	AT7224NC



Large Display/Storage Basket

Storage Baskets — {10.05}

Generous-sized baskets attach in seconds to hanger rail or shelves.

Width/Length/Depth (in.)	Width/Length/Depth (mm)	Approx. Pkd. Wt. (lbs.) (kg)		Cat. No. Plated	Cat. No. Black	Cat. No. White	Cat. No. Smoked Glass
13.37x5x7	345x127x180	8.5	4	H209C	H209B	H209W	H209-DSG
17.37x7.5x5	440x190x127	7	3	H210C	H210B	H210W	H210-DSG
17.37x7.5x10	440x190x255	11	5	H212C	H212B	H212W	H212-DSG



File Basket

File Basket — {10.05}

The convenient place to keep files and papers.

- Measures 2.62"W x 12.75" L x 8.75" H (67mm W x 324mm L x 222mm H).
- Large enough to hold standard-size file folders.
- Attaches easily.

Width/Length (in.)		Width/Length (mm)		Height (in.)		Height (mm)		Approx. Pkd. Wt. (lbs.) (kg)		Cat. No.
2.62x12.75	63x330			8.75	228	2.1	1.0			PH1239C



SUPER ERECTA® SHELVING ACCESSORIES

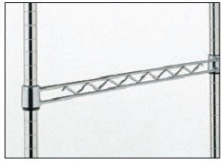

Hanger Rail

Hanger Rails — {10.05}

Convenient rail fits on posts along the width or length of the unit. Optional hooks can hang from rail at any point.

Length†		Approx. Pkd. Wt.		Cat. No.	Cat. No.	Cat. No.	Cat. No.	Cat. No.
(in.)	(mm)	(lbs.)	(kg)	Chrome	Black	White	Smoked Glass	Copper Hammetone
14	355	1	.45	H114C	H114B	H114W	H114-DSG	H114-DCH
18	457	1.25	.57	H118C	H118B	H118W	H118-DSG	H118-DCH
24	610	1.5	.68	H124C	H124B	H124W	H124-DSG	H124-DCH
30	760	1.5	.68	H130C	H130B	H130W	H130-DSG	H130-DCH
36	914	2	.90	H136C	H136B	H136W	H136-DSG	H136-DCH
48	1219	2.5	1.13	H148C	H148B	H148W	H148-DSG	H148-DCH

†14", 18" and 24" (355, 457 and 610mm) sizes fit shelf width (depth). 30", 36" and 48" (760, 914 and 1219mm) sizes fit shelf length.



Extension Display Hanger

Extension Display Hanger — {10.06}

Snaps on Super Erecta Shelf hanger rails and shelf frames. Accepts standard carded merchandise.

Length		Approx. Pkd. Wt.		Finish/Color*	Cat. No.
(in.)	(mm)	(lbs.)	(kg)		
6	152	.25	.1	Chrome	HHK6C
6	152	.25	.1	Black	HHK6B
8	203	.25	.1	Chrome	HHK8C
8	203	.25	.1	Black	HHK8B

*White, smoked glass and copper hammetone also available. 4-6 week lead time. Contact your Metro representative.

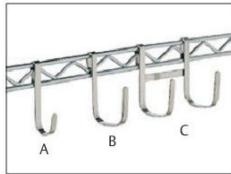

Snap-on Hooks

Snap-On Hooks — {10.05}

Multi-purpose hooks in three styles attach to hanger rails, mounting rails or shelves for instant access.

Description	Height	Cat. No.	Cat. No.
	(in.) (mm)	Chrome	Black
Style A — Small	3.44 90	HK23C	HK23B
Style B — Large	3.44 90	HK25C	HK25B
Style C — Double	3.44 90	HK26C	



Swing Hanger

Swing Hanger — {10.05}

Attaches to post to provide convenient storage for hanging items. Epoxy finish.

Arm Length		Weight Capacity		Cat. No.
(in.)	(mm)	(lbs.)	(kg)	
6.25	160	20	9	H110BL

SHELVING AND CART COVERS



21X48X54UCMB
(shown in Mariner Blue)

Shelving and Cart Covers — {11.80}

- Help protect contents from dust and other airborne contaminants.
- This allows units to be loaded and stored for longer periods of time before being transported. Covers also deter pilferage.
- Reinforced corners help prevent tears and add greatly to durability of covers.
- Choice of closure: Available in hook/loop or heavy-duty nylon zipper

Uncoated — machine washable:

- White: Knitted polyester, 4 oz. per square yard
- Mariner Blue: Woven polyester, 3.2 oz. per square yard.

Coated — waterproof, perfect for indoor/outdoor use:

- White or Mariner Blue — vinyl-coated nylon, 10 oz. per square yard
- Specially treated to resist bacteria, odor, mildew and flames

Catalog Numbers shown are for white cover. Add "MB" suffix to order Mariner Blue (i.e. 21X48X54UCMB)

Length/Height (in.)	Length/Height (mm)	White Nylon Uncoated		White Vinyl Coated	
		Zippered Closure Cat. No.	Velcro Closure Cat. No.	Zippered Closure Cat. No.	Velcro Closure Cat. No.
FOR SHELF TRUCKS & CARTS 18" (457mm) DEEP					
36x54	914x1370	18X36X54UC	18X36X54VUC	18X36X54C	18X36X54VC
36x62	914x1550	18X36X62UC	18X36X62VUC	18X36X62C	18X36X62VC
48x54	1219x1370	18X48X54UC	18X48X54VUC	18X48X54C	18X48X54VC
48x62	1219x1550	18X48X62UC	18X48X62VUC	18X48X62C	18X48X62VC
60x54	1524x1370	18X60X54UC	18X60X54VUC	18X60X54C	18X60X54VC
60x62	1524x1550	18X60X62UC	18X60X62VUC	18X60X62C	18X60X62VC
FOR SHELF TRUCKS & CARTS 21" (530mm) DEEP					
48x54	1219x1370	21X48X54UC	21X48X54VUC	21X48X54C	21X48X54VC
48x62	1219x1550	21X48X62UC	21X48X62VUC	21X48X62C	21X48X62VC
48x74	1219x1850	21X48X74UC	21X48X74VUC	21X48X74C	21X48X74VC
60x54	1524x1370	21X60X54UC	21X60X54VUC	21X60X54C	21X60X54VC
60x62	1524x1550	21X60X62UC	21X60X62VUC	21X60X62C	21X60X62VC
60x74	1524x1850	21X60X74UC	21X60X74VUC	21X60X74C	21X60X74VC
FOR SHELF TRUCKS & CARTS 24" (610mm) DEEP					
36x54	914x1370	24X36X54UC	24X36X54VUC	24X36X54C	24X36X54VC
36x62	914x1550	24X36X62UC	24X36X62VUC	24X36X62C	24X36X62VC
36x74	914x1850	24X36X74UC	24X36X74VUC	24X36X74C	24X36X74VC
48x54	1219x1370	24X48X54UC	24X48X54VUC	24X48X54C	24X48X54VC
48x62	1219x1550	24X48X62UC	24X48X62VUC	24X48X62C	24X48X62VC
48x74	1219x1850	24X48X74UC	24X48X74VUC	24X48X74C	24X48X74VC
60x54	1524x1370	24X60X54UC	24X60X54VUC	24X60X54C	24X60X54VC
60x62	1524x1550	24X60X62UC	24X60X62VUC	24X60X62C	24X60X62VC
60x74	1524x1850	24X60X74UC	24X60X74VUC	24X60X74C	24X60X74VC
72x54	1825x1370	24X72X54UC	24X72X54VUC	24X72X54C	24X72X54VC
72x62	1825x1550	24X72X62UC	24X72X62VUC	24X72X62C	24X72X62VC
72x74	1825x1850	24X72X74UC	24X72X74VUC	24X72X74C	24X72X74VC

*Cart covers are non-returnable.
Note: 86" (2185mm) high covers, in 24" (610mm) depth, available by special order.



Clear Vinyl
Cart Cover

Clear Vinyl Cart Covers

- Allows visual access while protecting shelf contents from dust and other airborne contaminants.
- Vinyl construction with Velcro closures.
- Available for 18" x 36" (457 x 914mm) shelving.

Length/Height (in.)	Length/Height (mm)	Cat. No.
36x32	914x889	GWCV41
36x52	914x1320	GWCV62

☑ Indicates antimicrobial product.



COMPUTER ACCESSORIES

Keyboard Tray — {10.06}

Attaches to all Metro wire shelves, 36" (914mm) length or longer. Mouse Tray adapts to left or right of Keyboard Tray. Flip-top compartment provides convenient storage. Constructed of durable high-impact polystyrene. Assembles easily.

- Hardware included for attachment to Metro wire shelves; template provided for attachment to solid desk surfaces.
- Keyboard Tray Dimensions: 22" L (559mm) x 15.5" W (394mm).
- Dimension with Mouse Tray fully extended: 29.5" L (749mm) x 15.5" W (394mm).

Cat. No. CKS1522BL



Keyboard Tray

Wire Management Clip — {10.06}

Keeps wires and cables neatly organized both horizontally and vertically. Easily snaps over the edge of any Super Erecta wire or qwikSLOT shelf. Black epoxy finish.

Width		Length		Approx. Pkd. Wt.		Cat. No.
(in.)	(mm)	(in.)	(mm)	(lbs.)	(kg)	
2	51	2	51	.5	.25	CWM



Wire Management Clip

Power Strip — {10.06}

- Mounts quickly and easily to either a Super Erecta or qwikSLOT post.
- Includes a 15 foot (4572mm) long cord.
- Mounting brackets and hardware included.
- UL/CSA approved.
- 15 Amp Circuit Breaker.
- Illuminated Power Switch. 15A/125VAC.60Hz/1875 W.
- Gray/blue finish.
- 14/3 SJT Molded Power Supply Cord.

Width		Length		Approx. Pkd. Wt.		Cat. No.
(in.)	(mm)	(in.)	(mm)	(lbs.)	(kg)	
1.5	38	48	1219	6	2.72	CPS48

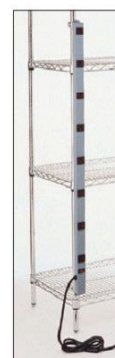

Power Strip

Surface Mount Swing Arm for Flat Monitor — {10.06}

- Range: Vertical, 15.9" (404mm); Horizontal 24.25 (613mm)
- Vertical Rotation: 360 degrees at three joints
- Monitor tilt: 200 degrees
- Monitor pivot: landscape to portrait
- Compatibility: VESA® 75mm and 100mm
- Cable management: Cables are concealed in arm
- Maximum weight load: 27.5 lbs. (12.5kg)

Cat. No. LTFMA

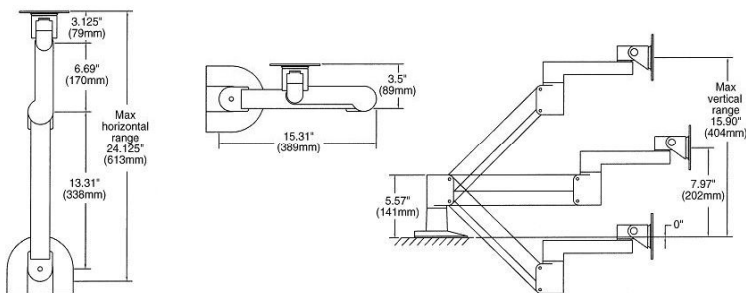

SUPER ERECTA® SOLID SHELVING



Super Erecta® Solid Shelving — {10.20}

Features a 0.12" (3.2mm) raised "ship's edge" on all four sides to contain spills. Louvered/embossed shelf allows air circulation. Available in several styles and materials for a variety of applications. Shelves are constructed with 18-gauge stainless steel (Type 304) or galvanized materials.

Galvanized shelves with uncoated cast corners

Ideal for applications requiring a solid shelving or work surface and minimum resistance to corrosion. Available in flat solid and louvered/embossed styles.

Standard Stainless Steel solid shelves

(Type 304) with epoxy-coated cast corners address the majority of applications for solid, corrosion resistant shelves or work surfaces. Available in flat solid and louvered/embossed styles.

Premium Autoclave/Cart Washable Stainless Steel Solid Shelves

(Type 304) feature an all-stainless construction to withstand high temperature, corrosive applications. Available in flat solid style.

Perfect for applications involving spillage. Provides barrier between floor and bottom shelf contents to deter contamination.



Flat Solid Stainless Shelves with black epoxy-coated corners

Width/Length (in)	Width/Length (mm)	GALVANIZED		STAINLESS STEEL	
		Cat. No. Flat	Cat. No. Louvered/Embossed	Cat. No. Flat	Cat. No. Louvered/Embossed
14x24	355x610	1424FG	1424LG	1424FS	1424LS
14x30	355x760	1430FG	1430LG	1430FS	1430LS
14x36	355x914	1436FG	1436LG	1436FS	1436LS
14x42	355x1066	1442FG	1442LG	1442FS	1442LS
14x48	355x1219	1448FG	1448LG	1448FS	1448LS
14x60	355x1524	1460FG	1460LG	1460FS	1460LS
18x24	457x610	1824FG	1824LG	1824FS	1824LS
18x30	457x760	1830FG	1830LG	1830FS	1830LS
18x36	457x914	1836FG	1836LG	1836FS	1836LS
18x42	457x1066	1842FG	1842LG	1842FS	1842LS
18x48	457x1219	1848FG	1848LG	1848FS	1848LS
18x54	457x1370	1854FG	-	1854FS	-
18x60	457x1524	1860FG	1860LG	1860FS	1860LS
18x72	457x1829	1872FG	-	1872FS	-
21x24	530x610	2124FG	2124LG	2124FS	2124LS
21x30	530x760	2130FG	2130LG	2130FS	2130LS
21x36	530x914	2136FG	2136LG	2136FS	2136LS
21x42	530x1066	2142FG	2142LG	2142FS	2142LS
21x48	530x1219	2148FG	2148LG	2148FS	2148LS
21x60	530x1524	2160FG	2160LG	2160FS	2160LS
24x24	610x610	2424FG	2424LG	2424FS	2424LS
24x30	610x760	2430FG	2430LG	2430FS	2430LS
24x36	610x914	2436FG	2436LG	2436FS	2436LS
24x42	610x1066	2442FG	2442LG	2442FS	2442LS
24x48	610x1219	2448FG	2448LG	2448FS	2448LS
24x54	610x1370	2454FG	-	2454FS	-
24x60	610x1524	2460FG	2460LG	2460FS	2460LS
24x72	610x1829	2472FG	-	2472FS	-

Note: Weight Capacity (evenly distributed load): Shelves 48" (1219mm) or less in length can hold up to 800 lbs. (363kg). 60" (1524mm) long shelves can hold up to 600 lbs. (272kg). 72" (1829mm) long shelves can hold up to 300 lbs. (136kg). For standard packaging, the number of shelves per box varies by size. 14'118" (355/457mm) wide solid shelving: less than 60" (1524mm) long (no more than 4 per carton); 60" (1524mm) long (no more than 2 per carton); 21' (530mm) wide solid shelving: less than 42" (1066mm) long (no more than 4 per carton); 42" (1066mm) or longer (no more than 2 per carton); 24' (610mm) wide solid shelving: 24', 30' (610, 760mm) long (no more than 4 per carton); 36' (914mm) or longer (no more than 2 per carton).



SUPER ERECTA® SOLID SHELVING

Autoclavable/Cart-Washable Solid Stainless Shelving

All-stainless construction to address autoclave and cart washing applications.

Width/Length (in.) (mm)		Approx. Pkd. Wt. per Shelf (lbs.) (kg)		Cat. No. Autoclavable Stainless	Width/Length (in.) (mm)		Approx. Pkd. Wt. per Shelf (lbs.) (kg)		Cat. No. Autoclavable Stainless
14x24	355x610	10	4.5	1424NFS	21x24	530x610	13	5.9	2124NFS
14x30	355x760	12	5.4	1430NFS	21x30	530x760	15	6.8	2130NFS
14x36	355x914	14	6.4	1436NFS	21x36	530x914	18	8.2	2136NFS
14x42	355x1066	15	6.8	1442NFS	21x42	530x1066	21	9.5	2142NFS
14x48	355x1219	17	7.7	1448NFS	21x48	530x1219	23	10.4	2148NFS
14x60	355x1524	22	9.9	1460NFS	21x60	530x1524	26	11.8	2160NFS
18x24	457x610	11	5.0	1824NFS	24x24	610x610	15	6.8	2424NFS
18x30	457x760	14	6.4	1830NFS	24x30	610x760	17	7.7	2430NFS
18x36	457x914	16	7.3	1836NFS	24x36	610x914	19	8.6	2436NFS
18x42	457x1066	18	8.2	1842NFS	24x42	610x1066	21	9.5	2442NFS
18x48	457x1219	20	9.1	1848NFS	24x48	610x1219	24	10.9	2448NFS
18x60	457x1524	24	10.9	1860NFS	24x60	610x1524	31	14.0	2460NFS

Metro Tip:
Order aluminum split sleeves with stainless C-rings for corrosive, high-temperature autoclave or cart washing applications. (Cat. No. 9986S, one bag required per shelf).



SiteSelect™ Posts are grooved at 1" (25mm) increments and numbered at 2" (50mm) increments. Posts are double-grooved every 8" (203mm) for easy identification.

SiteSelect® Posts for Super Erecta® Solid Shelving — {10.20}

Stationary posts are fitted with adjustable leveling bolts to compensate for uneven surfaces. Mobile posts come without leveling bolt to accommodate stem casters. Special length posts are available.†

(in.)	Height* (mm)	Approx. Pkd. Wt. (lbs.) (kg)		Cat. No. Chrome Stationary	Cat. No. Chrome Mobile	Cat. No. Cart Wash/ Autoclave	Cat. No. Stainless Stationary**	Cat. No. Stainless Mobile
7.5	191	.5	0.3	7P	7UP	-	-	-
14.5	370	1	0.5	13P	13UP	-	13PS	13UPS
27.5	699	1.75	0.75	27P	27UP	-	27PS	27UPS
34.5	875	2	0.9	33P	33UP	33UPS-SW	33PS	33UPS
54.56	1385	3	1.4	54P	54UP	54UPS-SW	54PS	54UPS
62.56	1590	3.5	1.6	63P	63UP	63UPS-SW	63PS	63UPS
74.62	1895	4	1.8	74P	74UP	-	74PS	74UPS
86.62	2200	5	2.3	86P	86UP	-	86PS	86UPS
96.62	2454	5.5	2.5	***96P	-	-	-	-

†Note: Special length posts are available, priced at next higher length plus a cutting charge.
‡Post lengths to be specified as cut to a round number, ie: 74P cut to 69" (1753mm). This will result in an overall post height with adjustment of 69.37" (1762mm) to 69.87" (1775mm).
*Height includes leveling bolt and cap.
**Stainless stationary post includes stainless leveling bolt.
***96P should not be used on units less than 24" (610mm) deep. Consult Metro Engineering for alternate recommendations.



Super Erecta® Counter Units — {10.35}

To create a counter unit, select the following components:

- 2 each — 14" (355mm) deep upper shelves, (see page 74)
- 2 each — 24" (610mm) deep lower shelves, (see page 74)
- 2 each — upper front posts, listed below
- 2 each — lower front posts, listed below
- 2 each — 63" (1600mm) or 74" (1880mm) high back posts (listed above).

Special Posts For Counter Units — {10.35}

	Unit Height (in.) (mm)	Post Height* (in.) (mm)	Approx. Pkd. Wt. (lbs.) (kg)		Cat. No. Plated	Cat. No. Stainless
Upper Front Posts	63 1600	28.62 727	1 1/2	0.7	27PF	27PFS
	74 1880	40.62 1032	2	0.9	39PF	39PFS
Lower Front Posts	All Heights	34.5 877	2	0.9	33PM	33PMS

*Height includes leveling bolt and cap.



Counter Unit with galvanized shelves.

SUPER ERECTA® SOLID SHELVING ACCESSORIES



Chrome ledges with plated steel clips



Stainless ledge with polymer clip



Rods with Tab in place



Shelf Dividers



Joining Clamp



Adjustable Undershelf Slides

Shelf Ledges for Solid Shelves — {10.25}

Sturdy 4" (101mm) ledges contain items on shelves. Spring-clip tabs included for attachment.

Note: ledges are not stackable.

Fits Shelf Length (in.)	(mm)	Cat. No. Plated	Cat. No. Stainless
14	355	L14WC	L14WS
18	457	L18WC	L18WS
21	530	L21WC	L21WS
24	610	L24WC	L24WS
30	760	L30WC	L30WS
36	914	L36WC	L36WS
42	1066	L42WC	L42WS
48	1219	L48WC	L48WS
60	1524	L60WC	L60WS

*Actual ledge length is approximately 1" (25mm) shorter than nominal shelf length/width. Standard spring-clip tabs are plated steel.



Chrome Plated Ledge Clip
6 Per Bag
Cat. No. 9184Z



Polymer Ledge Clip for use with stainless Steel ledges
6 Per Bag
Cat. No. 9184P



Additional Tabs
Bag of 6
Cat. No. 9184Z

Note: Standard tabs are plated steel

For applications requiring a corrosion proof solution, consult your Metro representative.

Rods and Tabs for Solid Shelves — {10.25}

Create a more versatile system by enclosing sides and back of an entire unit. Tabs required to attach rods to a 4-shelf unit are supplied. Additional tabs also available in bags of 6.

Rods

Min. Post Height (in.)	Rod Length (in.)	(mm)	Approx. Pkd. Wt. (lbs.)	(kg)	Cat. No. Plated
54	52	1320	1	0.5	R52FC
63	60	1524	1	0.5	R60FC
74	72	1830	1.25	0.6	R72FC
86	84	2135	1.5	0.7	R84FC

Note: Standard spring-clip tabs are plated steel.

Shelf Dividers — {10.25}

The easy way to keep shelves orderly. 8" (203mm) high dividers attach with provided spring clips.

Length (in.)	(mm)	Approx. Pkd. Wt. Per 5 Pieces (lbs.)	(kg)	Cat. No. Plated	Cat. No. Stainless
14	355	12	5.4	DD14FC	
18	457	13.5	6.0	DD18FC	DD18FS
21	530	15	6.8	DD21FC	
24	610	16.5	7.4	DD24FC	DD24FS

Solid Shelf Joining Clamp — {10.25}

Save time and money by eliminating adjacent posts and replacing with solid shelf joining clamps. Join units end-to-end, back-to-back or at right angles. Two clamps required per shelf to attach to adjacent units. **Cat. No. 9998Z**

Note: Shelves with joining clamps can only be attached to shelves supported by two or more posts.

Adjustable Undershelf Slides — {10.25}

Create a convenient drawer system by combining a tote box with these slides. Two slides are required, and can be spaced to fit any width container.

Item	Approx. Pkd. Wt. (lbs.)	(kg)	Cat. No. Solid
For 18" (457mm) wide shelf	1	0.4	US18FA
For 21" (530mm) wide shelf	1	0.4	US21FA
For 24" (610mm) wide shelf	1	0.4	US24FA

For application-specific totes, refer to index.



ERECTA SHELF® SHELVING

Erecta Shelf® Shelving

- This easy-to-assemble system puts space to work practically anywhere.
- Units go together without tools — shelf grooves simply lock into uprights at 5" (127mm) increments.
 - Accessories create a truly versatile system.



Erecta Shelf® Uprights — {10.50}

Width/Length		Approx. Pkd. Wt.		Cat. No. Chrome
(in.)	(mm)	(lbs.)	(kg)	
12x53.5	305x1359	7	3.2	1252C
12x63.5	305x1613	8	3.3	1262C
12x73.5	305x1867	9	4.1	1272C
12x88.5	305x2248	11	5.0	1287C
18x53.5	457x1359	8	3.3	1852C
18x63.5	457x1613	9	4.1	1862C
18x73.5	457x1867	11	5.0	1872C
18x88.5	457x2248	13.5	6.2	1887C

Packaging: 6 uprights to a carton.

Erecta Shelf® Wire Shelves — {10.50}

Width/Length		Approx. Pkd. Wt.		Cat. No. Chrome
(in.)	(mm)	(lbs.)	(kg)	
12x24	305x610	5	2.2	1224C
12x30	305x760	6	2.7	1230C
12x36	305x914	7	3.1	1236C
12x42	305x1066	8.25	3.7	1242C
12x48	305x1219	9.5	4.2	1248C
12x60	305x1524	12	5.4	1260C
18x24	457x610	6.5	2.9	1824C
18x30	457x760	8	3.6	1830C
18x36	457x914	10	4.5	1836C
18x42	457x1066	11	4.9	1842C
18x48	457x1219	12.5	5.6	1848C
18x60	457x1524	16	7.2	1860C

Load Rating: Shelves up to 48" Long – 800 lbs. (363 kg) equally distributed.
 Shelves 60" Long – 600 lbs. (277 kg) equally distributed.
 Maximum – 2000 lbs. (907 kg) per 4 shelf unit

Shelf Dividers

Keep shelves orderly with these snap-in-place, 8" (203mm) high dividers.

Shelf Width	Approx. Pkd. Wt. Per 6 Pieces	Approx. Pkd. Wt.		Cat. No. Plated
(in.) (mm)	(lbs.) (kg)	(lbs.)	(kg)	
12 305	12 5.4	12	5.4	DD12C
18 457	13.5 6.1	13.5	6.1	DD18C
24 610	16.5 7.4	16.5	7.4	DD24C



Shelf Divider

HD SUPER™ SHELVING



HD Super Solid Stainless Shelving with black epoxy-coated corners



HD Super Post



HD Super Stem Caster Post



HD Super Stem Caster

HD Super™ Solid Stainless Shelving

Heavy-duty system features 16-gauge solid shelves.

- Large 1.62" (41mm) diameter posts and 2" (51mm) shelf adjustability.

HD Super Flat Shelves — {10.65}

Width/Length (in.)	Width/Length (mm)	Approx. Pkd. Wt.		Cat. No. Stainless
		(lbs.)	(kg)	
18x36	457x914	21	9.5	1836HFS
18x42	457x1066	23	10.4	1842HFS
18x48	457x1219	26	11.7	1848HFS
18x54	457x1370	28	12.7	1854HFS
18x60	457x1524	31	14.0	1860HFS
24x36	610x914	25	11.3	2436HFS
24x42	610x1066	29	13.1	2442HFS
24x48	610x1219	32	14.4	2448HFS
24x54	610x1370	35	15.8	2454HFS
24x60	610x1524	38	17.1	2460HFS

Load Ratings: Shelf: 1,000 lbs. (454kg) evenly distributed per shelf, not to exceed unit load rating. Stationary Unit: 3,000 lbs. (1363 kg.) evenly distributed. Mobile Unit: 1,000 lbs. (454 kg) with casters.

HD Super Stationary Posts — {10.65}

Height* (in.)	Height* (mm)	Approx. Pkd. Wt.		Cat. No. Stainless
		(lbs.)	(kg)	
56	1421	5.8	2.6	54HPS
64	1624	6.3	2.9	63HPS
76	1929	7.5	3.4	74HPS

*Height includes leveling foot and cap. Special length posts are available. For more information, contact your Metro representative.
Packaging: 4 posts to a carton.

HD Super Stem Caster Posts — {10.65}

Height (in.)	Height (mm)	Approx. Pkd. Wt.		Cat. No. Stainless
		(lbs.)	(kg)	
54.56	1386	5.7	2.5	54UHPS
62.56	1590	6.3	2.8	63UHPS
74.62	1894	7.5	3.3	74UHPS

HD Super Stem Casters

Includes donut bumpers with each caster.

Wheel Diameter (in.)	Wheel Diameter (mm)	Face Diameter (in.)	Face Diameter (mm)	Type	Wheel Tread	Cat. No.
5	127	1.5	38.1	Swivel	Polyurethane	5HHP
5	127	1.5	38.1	Brake	Polyurethane	5HHPB

Load rating per caster: 400 lbs. (182kg).

HD Super shelves, posts, and casters are not compatible with Super Erecta or Super Adjustable Super Erecta components.



HD SUPER® ACCESSORIES

HD Super Dunnage Shelves — {10.67}

Static load capacity (uniformly distributed)

- 48" (1219mm) shelf: 3,000 lbs. (1361kg).
- 60" (1524mm) shelf: 2,400 lbs. (1089kg).
- For use on HD Super 1.62" (41mm) diameter posts only.
- Removable wire deck.

Width/Length (in.)	Width/Length (mm)	Approx. Pkd. Wt.		Cat. No. Chrome
		(lbs.)	(kg)	
18x48	457x1219	35	15.7	1848HDRC
18x60	457x1524	43	19.3	1860HDRC
24x48	610x1219	38	17.1	2448HDRC
24x60	610x1524	47	21.1	2460HDRC

Important: In stationary shelving, stability decreases as the ratio of height to width increases and when heavier loads are placed on upper shelves. Keep units as wide and low as possible, using the dunnage shelf as the bottom shelf. If two dunnage shelves are being used, both should be placed within the lower half of the unit.
Note: Not compatible with Super Erecta or Super Adjustable Super Erecta components.

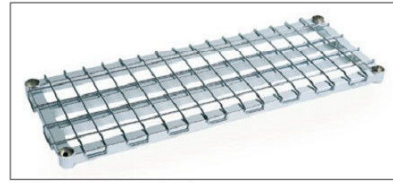

HD Super Dunnage Shelf

HD Super Cantilever Shelf — {10.67}

Width/Length (in.)	Width/Length (mm)	Approx. Pkd. Wt.		Cat. No. Stainless
		(lbs.)	(kg)	
12x54	304x1372	11.8	5.3	1254CHS
12x60	304x1524	12.7	5.7	1260CHS

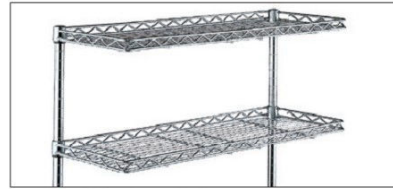

HD Super™ Cantilever Shelf

HD Super Replacement Parts — {10.65}

Replacement HD Super Aluminum Split Sleeves with Zinc Ring
 4 pair per bag
Cat. No. 9986HZ



Replacement HD Super™ Aluminum Split Sleeve

Replacement HD Super Plastic Split Sleeves

4 pair per bag
Cat. No. 9985H



Replacement HD Super™ Plastic Split Sleeve

Post Clamps

Cat. No. 9994HZ



Post Clamp

Replacement 5.5" (140mm) Donut Bumpers

Fit 1.62" (41mm) posts only.
Cat. No. 9992H



Replacement 5.5" (140mm) Donut Bumper

3.5" (89mm) Foot Plates

Cat. No. 9993HS



3.5" (89mm) Foot Plate

Wall Mounting Brackets

(not shown)
Cat. No. 9984HZ

Indicates antimicrobial product.



Why qwikSLOT?



Add or remove a shelf with ease.



Perfect for retail & grocery.

Why Drop Mat?



Keeps items contained.



Shelves only 1/4" thick.

Save space with built in Ledge.



QWIKSLOT® SHELVING

qwikSLOT® Display Shelving System Set, reset in a flash.

Metro qwikSLOT shelves offer the quality of Super Erecta with the convenience of easily adjustable and removable shelves.

- Unique support system snaps into the posts, allowing instant shelf adjustment.
- Each unit requires a standard Super Erecta shelf at the top and bottom. (see page 48)



Super Erecta qwikSLOT shelving unit in black epoxy

qwikSLOT® Shelves — {10.11}

Width / Length (in.)	Width / Length (mm)	Chrome Cat. No.	Black Cat. No.	Smoked Glass Cat. No.	Copper Hammeritone Cat. No.
14 x 36	355 910	1436QC	1436QBL	1436Q-DSG	1436Q-DCH
14 x 48	355 1220	1448QC	1448QBL	1448Q-DSG	1448Q-DCH
18 x 36	455 910	1836QC	1836QBL	1836Q-DSG	1836Q-DCH
18 x 48	455 1220	1848QC	1848QBL	1848Q-DSG	1848Q-DCH
18 x 60	455 1525	1860QC	-	-	-
21 x 36	530 910	2136QC	2136QBL	2136Q-DSG	2136Q-DCH
21 x 48	530 1220	2148QC	2148QBL	2148Q-DSG	2148Q-DCH
21 x 60	530 1525	2160QC	-	-	-
24 x 36	610 910	2436QC	2436QBL	2436Q-DSG	2436Q-DCH
24 x 48	610 1220	2448QC	2448QBL	2448Q-DSG	2448Q-DCH
24 x 60	610 1525	2460QC	-	-	-

Note: A typical unit will incorporate 4 qwikSLOT posts, at least 2 Super Erecta shelves (one at the top and bottom of unit) and as many qwikSLOT shelves as desired between the top and bottom shelf. A three sided frame is recommended for increased rigidity.

Note: A qwikSLOT shelf is rated at 300 lbs. (135kg) per shelf. A typical qwikSLOT unit is rated at 800 lbs. (375kg) capacity per unit. For higher unit capacities, an intermediate standard Super Erecta shelf must be installed approximately at mid-height on the unit.

Note: Mobile Applications: All mobile applications require an intermediate standard Super Erecta shelf, installed approximately at mid-height on the unit. Mobile posts come without leveling bolt assembly to accommodate stem casters. The qwikSLOT lock clip (9985QSL) is recommended for mobile applications.



qwikSLOT post with shelf clip

qwikSLOT® Posts — {10.11}

Clips snap into slots along the height of the post for shelf adjustment at 1" (25mm) intervals. Use for qwikSLOT shelving only.

Stationary

Dimensions Height (in.)	Dimensions Height (mm)	Plated Cat. No.	Black Cat. No.	Smoked Glass Cat. No.	Copper Hammeritone Cat. No.
34.5	875	33PQ	33PQBL	33PQ-DSG	33PQ-DCH
54.56	1385	54PQ	54PQBL	54PQ-DSG	54PQ-DCH
63.56	1590	63PQ	63PQBL	63PQ-DSG	63PQ-DCH
74.62	1895	74PQ	74PQBL	74PQ-DSG	74PQ-DCH
86.62	2200	86PQ	86PQBL	86PQ-DSG	86PQ-DCH

Note: Height includes leveling bolt and cap.

Mobile

Dimensions Height (in.)	Dimensions Height (mm)	Plated Cat. No.	Black Cat. No.	Smoked Glass Cat. No.	Copper Hammeritone Cat. No.
34.87	875	33UPQ	33UPQBL	33UPQ-DSG	33UPQ-DCH
54	1385	54UPQ	54UPQBL	54UPQ-DSG	54UPQ-DCH
62	1590	63UPQ	63UPQBL	63UPQ-DSG	63UPQ-DCH
74	1895	74UPQ	74UPQBL	74UPQ-DSG	74UPQ-DCH
86	2200	86UPQ	86UPQBL	86UPQ-DSG	86UPQ-DCH

Note: Posts come without leveling bolt assembly to accommodate casters.



qwikSLOT Locking Clip
Recommended for mobile applications.
Must be used with 9985QS shelf clips.
(Package of 4)
Cat. No. 9985QSL



Replacement qwikSLOT Shelf Clips
(Package of 4)
Cat. No. 9985QS

SET UP WITHIN GONDOLA STYLE SHELVING

1. Assemble your new Metro Display Shelving System (no tools required).
2. Remove upper shelves of your existing gondola unit. Do not remove the base shelf or kick panel.
3. Place your new Metro display shelving unit onto the gondola base shelf and slide into place.

Metro Tip: Order optional triangular foot plates to replace leveling bolts. Foot plates distribute heavy weight evenly.



SUPER ERECTA® DROP MAT & QWIKSLOT® DROP MAT SHELVING



Metro® qwikSLOT Drop Mat Shelving



Metro® Super Erecta Drop Mat Shelving

Perfect for:

- Retail Display
- Lean “Two-Bin”

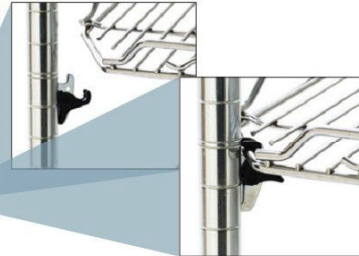

Metro® qwikSLOT Drop Mat Shelving

Super Erecta Drop Mat & qwikSLOT Drop Mat — {10.12}

Built-in shelf ledge, approximately 1" (25mm) high, prevents contents from falling off shelf. Each shelf holds up to 250lbs (113kg), 800lbs. (375kg) per unit. Available in Super Erecta and qwikSLOT styles. Available in stationary or mobile.

- qwikSLOT® Drop Mat offers a built-in shelf ledge and the convenience of easily removing or adjusting without disturbing the shelves below or above.
- Shelves can be installed flat or at an angle. All shelves adjust in 1" increments.

Super Erecta Drop Mat Shelving — To be used with Super Erecta posts (see page 49)

Width (in.)	Length (mm)	Approx. Pkd. Wt.		Cat. No. Chrome	Cat. No. Copper Hammer-tone	Cat. No. Black	Cat. No. White	Cat. No. Smoked Glass
		(lbs.)	(kg)					
14x36	355x914	7.25	3.2	HDM1436NC	HDM1436-DCH	HDM1436BL	HDM1436W	HDM1436-DSG
14x48	355x1219	9.75	4.3	HDM1448NC	HDM1448-DCH	HDM1448BL	HDM1448W	HDM1448-DSG
18x36	457x914	8.5	3.8	HDM1836NC	HDM1836-DCH	HDM1836BL	HDM1836W	HDM1836-DSG
18x48	457x1219	11.25	5.0	HDM1848NC	HDM1848-DCH	HDM1848BL	HDM1848W	HDM1848-DSG
21x36	530x914	10.75	4.8	HDM2136NC	HDM2136-DCH	HDM2136BL	HDM2136W	HDM2136-DSG
21x48	530x1219	13.25	5.9	HDM2148NC	HDM2148-DCH	HDM2148BL	HDM2148W	HDM2148-DSG
24x24	610x614	8.5	3.8	HDM2424NC	HDM2424-DCH	HDM2424BL	HDM2424W	HDM2424-DSG
24x36	610x914	12.25	5.5	HDM2436NC	HDM2436-DCH	HDM2436BL	HDM2436W	HDM2436-DSG
24x48	610x1219	15.25	6.8	HDM2448NC	HDM2448-DCH	HDM2448BL	HDM2448W	HDM2448-DSG



SUPER ERECTA® DROP MAT & QWIKSLOT® DROP MAT SHELVING



Mobile units require:
 1. Standard Super Erecta, Drop Mat Super Erecta or 3-Sided Frame top, middle and bottom shelves for rigidity.



2. Locking Clips on all qwikSlot levels.



Stationary units require:
 1. Standard Super Erecta top and bottom shelves for rigidity.



qwikSlot Locking Clip
 For mobile applications.
 To be used with qwikSlot shelf clips. (Package of 4)
Cat. No. 9985QSL



Casters types available for all mobile applications.

Wheel Diameter (in)	Wheel Diameter (mm)	Type	Resilient Tread Cat. No.	Polyurethane Tread Cat. No.
5	32	Swivel	5M	5MP
5	132	Swivel/Brake	5MB	5MPB

qwikSlot® Drop Mat Shelves — {10.12}

Increase storage capacity by as much as 30%. Each shelf holds up to 250 lbs (113kg). Shelves are easy to adjust and remove. Super Erecta or Super Erecta Drop Mat shelves are required at top and bottom. Use with qwikSlot posts (See Page 81).

Width/Length (in.)	Approx. Pkd. Wt. (lbs.)	Cat. No. Chrome	Cat. No. Black	Cat. No. Smoked Glass	Cat. No. Copper Hammerstone
14x36	7.25	HDM1436QC	HDM1436QBL	HDM1436Q-DSG	HDM1436Q-DCH
14x48	9.75	HDM1448QC	HDM1448QBL	HDM1448Q-DSG	HDM1448Q-DCH
18x36	8.5	HDM1836QC	HDM1836QBL	HDM1836Q-DSG	HDM1836Q-DCH
18x48	11.25	HDM1848QC	HDM1848QBL	HDM1848Q-DSG	HDM1848Q-DCH
21x36	10.75	HDM2136QC	HDM2136QBL	HDM2136Q-DSG	HDM2136Q-DCH
21x48	13.25	HDM2148QC	HDM2148QBL	HDM2148Q-DSG	HDM2148Q-DCH
24x36	12.25	HDM2436QC	HDM2436QBL	HDM2436Q-DSG	HDM2436Q-DCH
24x48	15.25	HDM2448QC	HDM2448QBL	HDM2448Q-DSG	HDM2448Q-DCH

qwikSlot® Posts — {10.11}

Clips snap into slots along the post for shelf adjustment at 1" (25mm) intervals. Use for qwikSlot shelving only.

Dimensions (in.)	Approx. Pkd. Wt. (lbs.)	Stationary				Mobile					
		Plated Cat. No.	Black Cat. No.	Smoked Glass Cat. No.	Copper Hammerstone Cat. No.	Plated Cat. No.	Black Cat. No.	Smoked Glass Cat. No.	Copper Hammerstone Cat. No.		
34.5	875	2	0.9	33PQ	33PQBL	33PQ-DSG	33PQ-DCH	33UPQ	33UPQBL	33UPQ-DSG	33UPQ-DCH
54.56	1385	3	1.4	54PQ	54PQBL	54PQ-DSG	54PQ-DCH	54UPQ	54UPQBL	54UPQ-DSG	54UPQ-DCH
63.56	1590	3.5	1.6	63PQ	63PQBL	63PQ-DSG	63PQ-DCH	63UPQ	63UPQBL	63UPQ-DSG	63UPQ-DCH
74.62	895	4	1.8	74PQ	74PQBL	74PQ-DSG	74PQ-DCH	74UPQ	74UPQBL	74UPQ-DSG	74UPQ-DCH
86.62	2200	5	2.3	86PQ	86PQBL	86PQ-DSG	86PQ-DCH	86UPQ	86UPQBL	86UPQ-DSG	86UPQ-DCH

Snap-On Dividers for Drop Mat Shelves — {10.04}

Organize your shelves with these 8" (203mm) high, easy to snap-in-place dividers.

Fits Shelf Width (in.)	Approx. Pkd. Wt. (lbs.)	Cat. No. Plated	Cat. No. Black	Cat. No. White	Cat. No. Smoked Glass	Cat. No. Copper Hammerstone		
18	457	2.5	1.1	HD18C	HD18B	HD18W	HD18-DSG	HD18-CH
24	614	3.5	1.6	HD24C	HD24B	HD24W	HD24-DSG	HD24-CH

*Refer to page 131 for information about Designer Colors.



Snap-On Divider



Quicker access with more versatility.

Metro® Super Erecta® basket shelves provide more options to our vast line of storage solutions.



Super Erecta “Hopper-Style” Basket Shelving — {10.85}

This hopper-style basket shelving provides easier ability to load supplies and access them when needed without fear of losing product from falling behind the shelf. Add casters to maximize efficiency by making the whole unit mobile. Integrates seamlessly with Metro's line of Super Erecta shelving.

- Easier access to supplies.
- Front edge design protects supplies from rips and tears.
- Stays rigid and strong for mobile use.
- Compatible with Super Erecta shelving, carts and track shelving.
- Baskets nest for more compact shipping (packed 2 per box).
- 1" wire mesh spacing.

Baskets:

Model No.	Length (in.)	Length (mm)	Width (in.)	Width (mm)	Basket Front Height (in.)	Basket Front Height (mm)	Basket Back Height (in.)	Basket Back Height (mm)
BSK1824NC	24	610	18	457	5	127	9	229
BSK1836NC	36	914	18	457	5	127	9	229
BSK1848NC	48	1219	18	457	5	127	9	229
BSK1860NC	60	1524	18	457	5	127	9	229
BSK2424NC	24	610	24	610	5	127	9	229
BSK2436NC	36	914	24	610	5	127	9	229
BSK2448NC	48	1219	24	610	5	127	9	229
BSK2460NC	60	1524	24	610	5	127	9	229



Baskets on Stationary Unit



SUPER ERECTA® BASKET SHELVING

Super Erecta "Hopper-Style" Basket Shelving Accessories — {10.85}



Casters
(See Page 58-59)



Posts
(See Page 49)

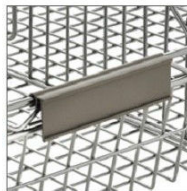

MetroMax Q Label Holders
MQ04LH (4") MQ48LH (48")
MQ24LH (24") MQ60LH (60")



Full-Width Label Holders
QB18LHC (18")
QB36LHC (36")
QB48LHC (48")



Dividers
BSKDIV-18H (18")
BSKDIV-24H (24")

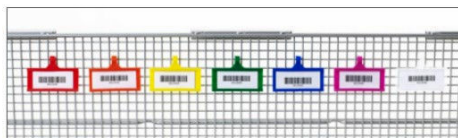

Colored Label Holder (shown with labels):
QB03LHRD - Red QB03LHOR - Orange QB03LHYL - Yellow
QB03LHGR - Green QB03LHBL - Blue QB03LHPK - Pink
QB03LHCL - Clear

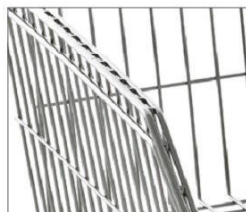

Wire ends are covered on all sides to protect against cut hands, damaged product, and punctured gloves.

Regular Basket Shelf — {10.04}

3.5" (89mm) deep basket with 400 lb. (182kg) weight capacity. Ideal for containing and displaying smaller items.

(in.)	Size (mm)	Cat. No. Chrome	Cat. No. Black
14x36	355x914	—	DD3448A
14x48	355x1219	—	DD3448B
18x36	457x914	CC9744A	CC9744C
18x48	457x1219	CC9744	CC9744B



Basket Shelf
(Posts sold separately, see page 42)

QWIKSIGHT™ BASKET SUPPLY SHELVING



Quick to find, quick to retrieve,
quick to restock the supplies you need.

qwikSIGHT

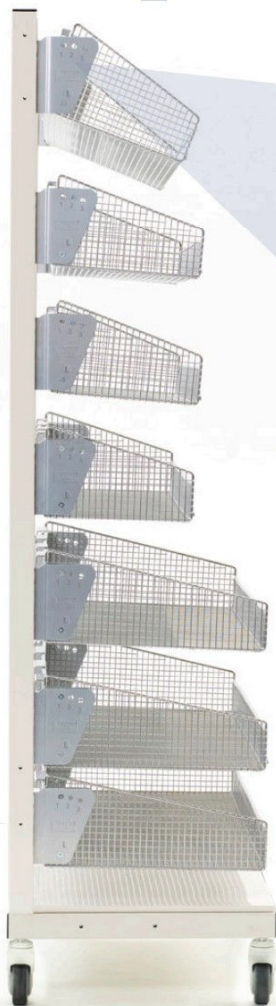

Accessible.

Adjustable angle basket brackets are easily repositioned for easy access and superior ergonomics.

Numbered uprights allow for quick, tool free, basket adjustment at 1" (25mm).



Touchable.



Superior design and high quality production shields personnel and supplies from incidental rips and tears.

The capacity to hold more.

Flexible.

Choose from single or double sided configurations. Stationary or mobile to make cleaning easier. Space efficient direct mount caster configuration or extension bars to increase stability when moved.



Casters are recommended for added clearance to clean under units.



Right sized.

Available in 12" (305mm) or 18" (457mm) widths and 18" (457mm), 36" (914mm) or 48" (1219mm) lengths. Baskets accept optional dividers and label holders.

Hold up to 500 lbs.

100 lbs. (45kg) per basket, 375 lbs. (170kg) per mobile unit, 500 lbs. (227kg) per stationary unit



QWIKSIGHT™ BASKET SUPPLY SHELVING

qwikSIGHT Basket Supply System — {18.01}

Preconfigured Units

Single-Sided Units — 21.5" (546mm) Wide

Description	Length		Height		Starter Cat. No.	Add-on Cat. No.
	(in.)	(mm)	(in.)	(mm)		
Stationary* 6 Level — Three 12" (305mm) D, Three 18" (457mm) D Baskets						
18"L, 6 Basket 3-18, Stationary	19.5	495	74	1880	QB118-S6	QB118-S6A
36"L, 6 Basket 3-18, Stationary	37.5	953	74	1880	QB136-S6	QB136-S6A
48"L, 6 Basket 3-18, Stationary	49.5	1257	74	1880	QB148-S6	QB148-S6A
Stationary* 7 Level — Three 12" (305mm) D, Four 18" (457mm) D Baskets						
18"L, 7 Basket 4-18, Stationary	19.5	495	74	1880	QB118-S7	QB118-S7A
36"L, 7 Basket 4-18, Stationary	37.5	953	74	1880	QB136-S7	QB136-S7A
Mobile** 6 Level — Three 12" (305mm) D, Three 18" (457mm) D Baskets						
18"L, 6 Basket 3-18, Mobile	19.5	495	79.5	2019	QB118-M6	QB118-M6A
36"L, 6 Basket 3-18, Mobile	37.5	953	79.5	2019	QB136-M6	QB136-M6A
48"L, 6 Basket 3-18, Mobile	49.5	1257	79.5	2019	QB148-M6	QB148-M6A
Mobile** 7 Level — Three 12" (305mm) D, Four 18" (457mm) D Baskets						
18"L, 7 Basket 4-18, Mobile	19.5	495	79.5	2019	QB118-M7	QB118-M7A
36"L, 7 Basket 4-18, Mobile	37.5	953	79.5	2019	QB136-M7	QB136-M7A

*Levelers add .37"-1.12" (16-35mm) to overall height for stationary.
 **Mobile units are intended to be moved for cleaning or relocating. Not designed for transport.
 *Caster with optional extender adds .5" (13mm) to overall unit height and 4.62" (117mm) to overall width of unit.
 †Add-on — Deduct 1" (25mm) from length shown for Add-on units.
 Weight Capacities: Basket — 100 lbs. (45kg), Mobile Unit — 375 lbs. (170kg), Stationary Unit — 500 lbs. (227kg)



QB136-M6



QB148-S7

Double-Sided Units — 40.5" (1029mm) Wide

Description	Length		Height		Starter Cat. No.	Add-on Cat. No.
	(in.)	(mm)	(in.)	(mm)		
Stationary* 6 Level — Six 12" (305mm) D, Six 18" (457mm) D Baskets						
18"L, 12 Basket 6-18, Stationary	19.5	495	74	1880	QB218-S12	QB218-S12A
36"L, 12 Basket 6-18, Stationary	37.5	953	74	1880	QB236-S12	QB236-S12A
48"L, 12 Basket 6-18, Stationary	49.5	1257	74	1880	QB248-S12	QB248-S12A
Stationary* 7 Level — Six 12" (305mm) D, Eight 18" (457mm) D Baskets						
18"L, 14 Basket 8-18, Stationary	19.5	495	74	1880	QB218-S14	QB218-S14A
36"L, 14 Basket 8-18, Stationary	37.5	953	74	1880	QB236-S14	QB236-S14A
48"L, 14 Basket 8-18, Stationary	49.5	1257	74	1880	QB248-S14	QB248-S14A
Mobile** 6 Level — Six 12" (305mm) D, Six 18" (457mm) D Baskets						
18"L, 12 Basket 6-18, Mobile	19.5	495	79.5	2019	QB218-M12	QB218-M12A
36"L, 12 Basket 6-18, Mobile	37.5	953	79.5	2019	QB236-M12	QB236-M12A
48"L, 12 Basket 6-18, Mobile	49.5	1257	79.5	2019	QB248-M12	QB248-M12A
Mobile** 7 Level — Six 12" (305mm) D, Eight 18" (457mm) D Baskets						
18"L, 14 Basket 8-18, Mobile	19.5	495	79.5	2019	QB218-M14	QB218-M14A
36"L, 14 Basket 8-18, Mobile	37.5	953	79.5	2019	QB236-M14	QB236-M14A
48"L, 14 Basket 8-18, Stationary	49.5	1257	79.5	2019	QB248-M14	QB248-M14A

*Levelers add .37"-1.12" (16-35mm) to overall height for stationary.
 **Mobile units are intended to be moved for cleaning or relocating. Not designed for transport.
 *Caster with optional extender adds .5" (13mm) to overall unit height and 4.62" (117mm) to overall width of unit.
 †Add-on — Deduct 1" (25mm) from length shown for Add-on units.
 Weight Capacities: Basket — 100 lbs. (45kg), Mobile Unit — 375 lbs. (170kg), Stationary Unit — 500 lbs. (227kg)



QB236-M12

QWIKSIGHT™ BASKET SUPPLY SHELVING



Single-Sided Frame
(shown with Casters)



Double-Sided Frame
(shown with Casters)

qwikSIGHT® Basket Supply System — {18.01}

Build-a-Unit — Components

Description	Width x Length (in.) (mm)		Height (in.) (mm)		Pk'd Weight (lbs.) (kg)		Cat. No.
Single Sided — Frames with Dust Cover* 21.5' (546mm)W							
18"L Starter	19.5	495	74	1880	36	16	QB1874-1
36"L Starter	37.5	953	74	1880	46	21	QB3674-1
48"L Starter	49.5	1257	74	1880	56	25	QB4874-1
18"L Adder	18.5	470	74	1880	25	11	QB1874-1A
36"L Adder	36.5	927	74	1880	35	16	QB3674-1A
48"L Adder	48.5	1232	74	1880	45	20	QB4874-1A

Double Sided — Frames with Dust Cover* 40.5' (1029mm)W

18"L Starter	19.5	495	74	1880	43	20	QB1874-2
36"L Starter	37.5	953	74	1880	55	25	QB3674-2
48"L Starter	49.5	1257	74	1880	67	30	QB4874-2
18"L Adder	18.5	470	74	1880	30	14	QB1874-2A
36"L Adder	36.5	927	74	1880	42	19	QB3674-2A
48"L Adder	48.5	1232	74	1880	54	24	QB4874-2A

Casters and Caster Extension Bars**

4" Diameter Brake Caster (Qty. 1)	1.25 x 4	32 x 102			7	3	QB4B
Single-Sided Caster Extension Bar	26.12 x 1.12	664 x 29	.5	13	10	5	QB18EB
Double-Sided Caster Extension Bar	44.25 x 1.12	1124 x 29	.5	13	13	6	QB36EB

Baskets with Brackets

12"D x 18"L Basket with Brackets	12 x 18	305 x 457	7	178	7	3	QB1218B
12"D x 36"L Basket with Brackets	12 x 36	305 x 914	7	178	10	5	QB1236B
12"D x 48"L Basket with Brackets	12 x 48	305 x 1219	7	178	13	6	QB1248B
18"D x 18"L Basket with Brackets	18 x 18	457 x 457	7	178	8	4	QB1818B
18"D x 36"L Basket with Brackets	18 x 36	457 x 914	7	178	13	6	QB1836B
18"D x 48"L Basket with Brackets	18 x 48	457 x 1219	7	178	16	7	QB1848B

Shelves with Brackets

18" x 18", Slanted Shelf	18 x 18	457 x 457	10	252	4	2	QB1818SS
18" x 36", Slanted Shelf	18 x 36	457 x 914	10	252	7	3	QB1836SS

Brackets — to convert panel mount baskets to frame mount baskets

Basket/Shelf Brackets, paid (L/R) with Hardware					1.7	0.8	QB2BRKT
---	--	--	--	--	-----	-----	----------------

*Levelers add .62"-1.12" (16-35mm) to overall height for stationary.
 **Mobile units are intended to be removed for cleaning or relocating. Not designed for transport.
 **Caster with extender adds .5" (13mm) to overall unit height and 4.62" (117mm) to overall width of unit.



QWIKSIGHT™ BASKET SUPPLY SHELVING

qwikSIGHT® Basket Supply System — {18.01}

Accessories

Description	Width x Length		Height		Pkd. Weight		Cat. No.
	(in.)	(mm)	(in.)	(mm)	(lbs.)	(kg)	
Dividers							
3"H Divider	6	152	3	76	.2	.1	QB03D
6"H Divider	6	152	6	152	.4	.2	QB06D
12"L Divider, Front to Back	12	305	6	152	.5	.2	QB12D
18"L Divider, Front to Back	18	457	6	152	.8	.4	QB18D

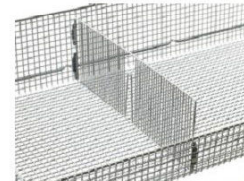

12" or 18" Basket Divider

Label Holders

18"L Label Holder, Clear (Qty. 1)	17	432	1.25	32	.2	.1	QB18LHC
36"L Label Holder, Clear (Qty. 1)	35	889	1.25	32	.3	.1	QB36LHC
48"L Label Holder, Clear (Qty. 1)	47	1194	1.25	32	.4	.2	QB48LHC
3" Label Holder, Blue (50/pkg.)	3	76	1.25	32	.6	0.3	QB03LHBL
3" Label Holder, Clear (50/pkg.)	3	76	1.25	32	.6	0.3	QB03LHCL
3" Label Holder, Green (50/pkg.)	3	76	1.25	32	.6	0.3	QB03LHGR
3" Label Holder, Orange (50/pkg.)	3	76	1.25	32	.6	0.3	QB03LHOR
3" Label Holder, Pink (50/pkg.)	3	76	1.25	32	.6	0.3	QB03LHPK
3" Label Holder, Red (50/pkg.)	3	76	1.25	32	.6	0.3	QB03LHRD
3" Label Holder, Yellow (50/pkg.)	3	76	1.25	32	.6	0.3	QB03LHYL



QB03D QB06D
Basket Dividers

Louvered Panel and Accessories

18" x 19" Louvered Panel	18	457	19	483	3	1	QB1819WP
18" x 61" Louvered Panel	18	457	61	1549	9	4	QB1861WP
36" x 19" Louvered Panel	36	914	19	483	5	2	QB3619WP
36" x 61" Louvered Panel	36	914	61	1549	17	8	QB3661WP
18" Frame Mounting Panel Bracket	5	127	18	457	3	1	QB18WPBRKT*
36" Frame Mounting Panel Bracket	5	127	36	914	5	2	QB36WPBRKT*
9" Light-Duty Spike — Single Rod	9	229			0.1	0.1	QB09WPS
10" Light-Duty Spike — Single Rod	10	254			0.1	0.1	QB10WPS
12" Equipment Spike — Heavy Duty	12	305			1	1	QB12WPS
12" x 18" Basket	12 x 18	305 x 457	7	178	6	3	QB1218
12" x 36" Basket	12 x 36	305 x 914	7	178	10	4	QB1236
12" x 48" Basket	12 x 48	305 x 1219	7	178	12	5	QB1248
18" x 18" Basket	18 x 18	457 x 457	7	178	7	3	QB1818
18" x 36" Basket	18 x 36	457 x 914	7	178	12	5	QB1836
18" x 48" Basket	18 x 48	457 x 1219	7	178	15	7	QB1848

*Brackets are required to mount louvered panel to qwikSIGHT frame. Two for 19"H panel, four for 61"H panel.

Clear Label Holder (shown with labels)



QB36LHC

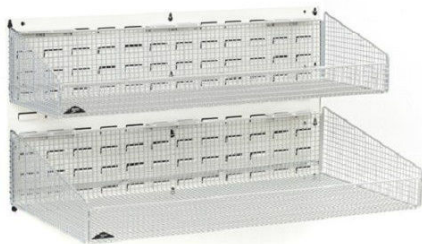

Louvered Panel
(Shown with Baskets)

Colored Label Holder (shown with labels)

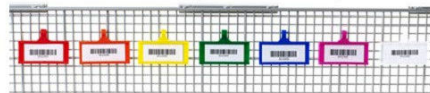

QB03LHRD - Red QB03LHOR - Orange QB03LHYL - Yellow
QB03LHGR - Green QB03LHBL - Blue QB03LHPK - Pink
QB03LHCL - Clear



QB09WPS



QB10WPS



QB12WPS

STORAGE BINS & TOTES



Metro Bins — {10.08}

Convenient way to organize and identify small items.

Bins of all sizes, for all items.



**Must Order
Bins & Dividers in
Case Quantities.**

Part numbers are for individual bins.



MB30164CLN



MB30184CLN



MB30174CLN

Shelf Bins — Nesting

These bins are sized to work on the two most popular shelf widths 18" (457mm) and 24" (610mm) for efficient handling and exchange.

Part No.	Outside Dimension (in.)		Outside Dimension (mm)		Bin Carton Quantity	Bin Color	Divider Carton Quantity	
	Length / Width / Height	Length / Width / Height	Length / Width / Height	Length / Width / Height			Width Dividers**	Divider Carton Quantity
MB30110CLN	11.6 x 2.75 x 4	295 x 70 x 102	24	Clear	N/A	N/A		
MB30120CLN	11.6 x 4.12 x 4	295 x 105 x 102	24	Clear	MB40120 (3)	24		
MB30130CLN	11.6 x 6.6 x 4	295 x 168 x 102	12	Clear	MB40130 (3)	24		
MB30150CLN	11.6 x 8.37 x 4	295 x 213 x 102	12	Clear	-	-		
MB30170CLN	11.6 x 11.12 x 4	295 x 282 x 102	12	Clear	MB40170 (3)	24		
MB30128CLN	17.8 x 4.12 x 4	454 x 105 x 102	12	Clear	MB40120 (3)	24		
MB30138CLN	17.8 x 6.6 x 4	454 x 168 x 102	12	Clear	MB40130 (3)	24		
MB30124CLN	23.6 x 4.12 x 4	600 x 105 x 102	12	Clear	MB40120 (3)	24		
MB30164CLN	23.6 x 6.6 x 4	600 x 168 x 102	6	Clear	MB40130 (3)	24		
MB30174CLN	23.6 x 10.6 x 4	600 x 270 x 102	2	Clear	MB40170 (3)	24		

Supply Bins — Stacking or Hanging

Stackable design maximizes vertical storage efficiency. Reinforced design adds strength and prevents spreading. Lip on rear of bin allows bin to hang on the wall panel.



MB30239CLSH



MB30235CLSH



MB30255CLSH

Part No.	Outside Dimension (in.)		Outside Dimension (mm)		Bin Carton Quantity	Color	Divider Carton Quantity	
	Length / Width / Height	Length / Width / Height	Length / Width / Height	Length / Width / Height			Length Dividers**	Divider Carton Quantity
MB30220CLSH	7.3 x 4.12 x 3	187 x 105 x 76	24	Clear	-	-		
MB30237CLSH	9.25 x 6 x 5	235 x 152 x 127	12	Clear	N/A	N/A		
MB30224CLSH	10.8 x 4.12 x 4	276 x 105 x 102	12	Clear	-	-		
MB30230CLSH	10.8 x 5.5 x 5	276 x 140 x 127	12	Clear	MB40230 (1)	6		
MB30235CLSH	10.8 x 11 x 5	276 x 279 x 127	6	Clear	MB40230 (2)	6		
MB30239CLSH	10.8 x 8.25 x 7	276 x 210 x 178	6	Clear	-	-		
MB30255CLSH	10.8 x 16.5 x 5	276 x 419 x 127	6	Clear	MB40230 (2)	6		
MB30234CLSH	14.75 x 5.5 x 5	375 x 140 x 127	12	Clear	-	-		
MB30240CLSH	14.75 x 8.25 x 7	375 x 210 x 178	12	Clear	MB40245 (1)	6		
MB30250CLSH	14.75 x 16.5 x 7	375 x 419 x 178	12	Clear	MB40245 (1)	6		
MB30265CLSH	18 x 8.25 x 9	457 x 210 x 229	6	Clear	MB40265 (1)	6		

Note: Bins feature a full-width hanger lip that is designed for use with hanging systems. Bins are available in carton quantities only.

Large Supply Bins — Stacking

Stacking maximizes vertical storage efficiency. Reinforced design prevents spreading.



MB30284CLS



MB30286CLS

Part No.	Outside Dimension (in.)		Outside Dimension (mm)		Bin Carton Quantity	Color	Dividers	Divider Carton Quantity
	Length / Width / Height	Length / Width / Height	Length / Width / Height	Length / Width / Height				
MB30281CLS	20 x 12.37 x 8	508 x 314 x 203	3	Clear	-	-		
MB30283CLS	20 x 18.37 x 12	508 x 467 x 305	1	Clear	-	-		
MB30284CLS	23.8 x 8.25 x 7	606 x 210 x 178	4	Clear	-	-		
MB30286CLS	23.8 x 11 x 7	606 x 279 x 178	4	Clear	-	-		
MB30289CLS	23.8 x 18.25 x 12	606 x 464 x 305	1	Clear	-	-		
MB30348T	20.5 x 8.25 x 7	521 x 210 x 178	6	Beige	width divider incl.	1		

**() Recommended max # of dividers per bin = # of divider slots may be higher to provide placement flexibility.
 Note: Bins are available in carton quantities only. Bins above are priced per each but must be ordered in multiples of carton quantity. (For example, MB30139CLN is available in quantities of 12, 24, 36. List price refers to the price of 1 bin.) Dividers are available in carton quantities only. Dividers are sold by the carton and priced by the carton. (For example: 1 MB40120 = 24 dividers, the list price is for 24 dividers). N/A indicates no divider available. "-" indicates divider available by special request.



STORAGE BINS & TOTES

Optimize for lean process.

Metro Two-Bin



TWO - DEEP

Shelf Depth	Part No.	Type
18"	MB30220CLSH	Stack/Hang Bin
18"	MB30237CLSH	Stack/Hang Bin
24"	MB30224CLSH	Stack/Hang Bin
24"	MB30230CLSH	Stack/Hang Bin
24"	MB30239CLSH	Stack/Hang Bin
24"	MB30235CLSH	Stack/Hang Bin
24"	MB30255CLSH	Stack/Hang Bin
24"	MB30110CLN	Nesting Bins
24"	MB30120CLN	Nesting Bins
24"	MB30130CLN	Nesting Bins
24"	MB30150CLN	Nesting Bins
24"	MB30170CLN	Nesting Bins

Part No. is per bin. Must order in case quantity.

TWO - WIDE



Shelf Depth	Part No.	Type
18"	MB30128CLN	Nesting Bins
18"	MB30138CLN	Nesting Bins
18"	MB30265CLSH	Stack/Hang Bin
24"	MB30124CLN	Nesting Bins
24"	MB30164CLN	Nesting Bins
24"	MB30174CLN	Nesting Bins

Part No. is per bin. Must order in case quantity.

TWO - HIGH



Shelf Depth	Part No.	Type
24"	MB30284CLS	Stacking Bin
24"	MB30286CLS	Stacking Bin
24"	MB30289CLS	Stacking Bin

Part No. is per bin. Must order in case quantity.

Louvered Wall Panel

For use with hanging supply bins. This universal hanging surface provides easy placement and configuration of multiple sizes of bins or qwikSIGHT Baskets. Wall-mounted panels keep items out of the way, off the floor and off the work table.

Part No.	Outside Dimension (in.) Length / Width / Height	Outside Dimension (mm) Length / Width / Height	Carton Quantity	Color	Weight (lb.)	Weight Capacity (kg)
MB1819LWP	18 x 0.31 x 19	457 x 8 x 483	4	White	160	73
MB3619LWP	36 x 0.31 x 19	914 x 8 x 483	4	White	160	73
MB1861LWP	18 x 0.31 x 61	457 x 8 x 1549	1	White	500	227

Note: Panel should be mounted on standard stud centers or a solid substrate (block, plywood, etc.) with fasteners in each mounting hole for maximum rigidity. Weight capacity listed is for the panel properly mounted to studs or a solid substrate. Fasteners are not included.

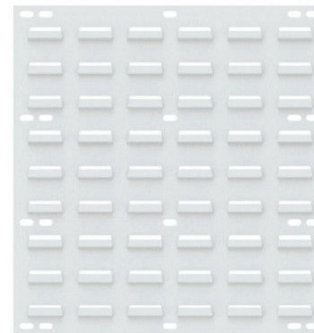

1" (25mm) Bin Rail Dividers

Create slots for bins and other packages as part of lean Kanban systems. Mounting clips attach to wire shelves and MetroMax open grid shelves. Kit consists of (8) chrome plated divider rails and (16) polymer mounting clips.

Part No.	Fits Shelf Depth (in)	(mm)	Approx. Pkd. Wt. (lbs.)	(kg)
BINRL18	18, 21	457, 533	6.3	2.9
BINRL24	24	610	7.8	3.5

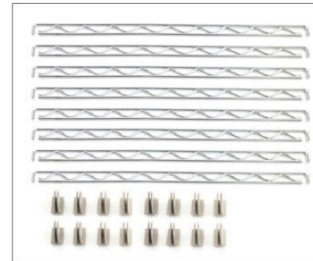

STORAGE BINS & TOTES



Totes offer a place for everything.



Totes Divider Boxes — {16.65}

Safe and efficient storage of items in bulk, or compartments with optional dividers and covers.

- Manufactured from polypropylene base resins.
- Available in natural gray (NAT), Benstat™ blue static dissipate (BAS), or Bentrion™ black conductive (CAS).
- Molded with more uniform wall thickness for a longer life.

Must Order Totes & Dividers in Case Quantities.



Dividers

Totes (sold in carton quantities as shown)

Cu. Cap (Cu. Ft.)	Inside Dimensions			Stack Depth (in.)	Outside Dimensions			Weight (lb.)	Weight (kg)	Carton Qty.*	Est. Carton Wt. (lbs.)	Cat. No. Natural Polypropylene	Cat. No. Benstat	Cat. No. Bentrion					
	Length (in.)	Width (in.)	Height (in.)		Length (in.)	Width (in.)	Height (in.)												
.10	9.19	233	6.56	167	3	176	10.87	276	8.25	210	3.5	89	37	16.8	48	37	TB91035NAT	TB91035BAS	TB91035CAS
.19	9.19	233	6.56	167	5.5	138	10.87	276	8.25	210	6	152	34	15.4	24	34	TB91060NAT	TB91060BAS	TB91060CAS
.24	14.87	378	9.25	235	3	76	16.5	419	10.87	276	3.5	89	36	16.3	24	36	TB92035NAT	TB92035BAS	TB92035CAS
.59	15	381	15	381	4.5	114	16.5	419	16.5	419	5	127	35	15.9	12	30	TB92050NAT	TB92050BAS	TB92050CAS
.44	14.87	378	9.25	235	5.5	138	16.5	419	10.87	276	6	152	28	12.7	12	28	TB92060NAT	TB92060BAS	TB92060CAS
.60	14.87	378	9.25	235	7.5	190	16.5	419	10.87	276	8	203	25	11.3	6	19	TB92080NAT	TB92080BAS	TB92080CAS
.44	20.62	524	15.62	397	2.5	63	22.5	571	17.5	445	3	76	36	16.3	12	31	TB93030NAT	TB93030BAS	TB93030CAS
.79	20.62	524	15.62	397	4.5	114	22.5	571	17.5	445	5	127	32	14.5	6	24	TB93050NAT	TB93050BAS	TB93050CAS
.97	20.62	524	15.62	397	5.5	138	22.5	571	17.5	445	6	152	24	10.9	6	24	TB93060NAT	TB93060BAS	TB93060CAS
1.32	20.62	524	15.62	397	7.5	190	22.5	571	17.5	445	8	203	21	9.5	4	21	TB93080NAT	TB93080BAS	TB93080CAS
2.03	20.62	524	15.62	397	11.5	292	22.5	571	17.5	445	12	305	20	9	3	20	TB93120NAT	TB93120BAS	TB93120CAS
.26	24.87	632	4.75	121	4.5	114	26.25	667	6.25	159	5	127	47	21.3	24	49	TB95050NAT	TB95050BAS	TB95050CAS

*Items must be purchased in carton quantities to avoid a broken lot charge. Pricing based on quantity ordered. Please consult your Metro representative.

Dividers

Fits Totes	Type	Height (mm)	Carton Qty.*	Est. Carton Wt. (lbs.)	Cat. No. Natural Polypropylene	Cat. No. Benstat	Cat. No. Bentrion	Type	Carton Qty.*	Est. Carton Wt. (lbs.)	Cat. No. Natural Polypropylene	Cat. No. Benstat	Cat. No. Bentrion	
TB91035	Long	3	76	96	12	DL91035NAT	DL91035BAS	DL91035CAS	Short	96	9	DS91035NAT	DS91035BAS	DS91035CAS
TB91060	Long	5.5	140	96	24	DL91060NAT	DL91060BAS	DL91060CAS	Short	96	17	DS91060NAT	DS91060BAS	DS91060CAS
TB92035	Long	3	76	96	21	DL92035NAT	DL92035BAS	DL92035CAS	Short	96	13	DS92035NAT	DS92035BAS	DS92035CAS
TB92060	Long	5.5	140	96	39	DL92060NAT	DL92060BAS	DL92060CAS	Short	96	33	DS92060NAT	DS92060BAS	DS92060CAS
TB92080	Long	7.5	191	96	54	DL92080NAT	DL92080BAS	DL92080CAS	Short	96	24	DS92080NAT	DS92080BAS	DS92080CAS
TB93030	Long	2.5	64	96	25	DL93030NAT	DL93030BAS	DL93030CAS	Short	96	34	DS93030NAT	DS93030BAS	DS93030CAS
TB93050	Long	4.5	114	96	44	DL93050NAT	DL93050BAS	DL93050CAS	Short	96	18	DS93050NAT	DS93050BAS	DS93050CAS
TB93060	Long	5.5	140	96	53	DL93060NAT	DL93060BAS	DL93060CAS	Short	96	32	DS93060NAT	DS93060BAS	DS93060CAS
TB93080	Long	7.5	191	96	72	DL93080NAT	DL93080BAS	DL93080CAS	Short	96	40	DS93080NAT	DS93080BAS	DS93080CAS
TB92050		4.5	114						Long/Short	96	55	DS92050NAT	DS92050BAS	DS92050CAS
TB95050		4.5	114						Short	96	55	DS95050NAT	DS95050BAS	DS95050CAS

*Items must be purchased in carton quantities to avoid a broken lot charge. Pricing based on quantity ordered. Please consult your Metro representative.



STORAGE TOTES & BINS

White Tote Divider Boxes — {16.64}

Metro's Divider Tote Box Line offers safe and efficient storage of items in bulk, or in compartmentalized fashion with the use of optional dividers. Manufactured of polypropylene material, these injection-molded totes are available in white and can be stored and transported in a variety of standard Metro products (e.g. PT Slide Trucks, Super Slide System, etc.).



Outside Dimensions (includes lip) Length x Width (in.)		Inside Dimensions Length x Width (mm)		Height O.D. (in.)	I.D.* (mm)	Capacity (cu. ft.)	Capacity (cu. m.)	Approx. Tote Box Wt. (lbs.)	White Cat. No.
10.87x8.25	276x210	9.12x6.5	232x165	3.5	89	.10	0.003	.77	MTB91035W
16.5x10.87	419x276	14.87x9.25	378x235	3.5	89	.24	0.007	1.5	MTB92035W
16.5x10.87	419x276	14.87x9.25	378x235	6	152	.44	0.012	2.33	MTB92060W
22.5x17.5	572x445	20.25x15.12	514x384	3	76	.44	0.017	2.57	MTB93030W
22.5x17.5	572x445	20.25x15.12	514x384	5	127	.79	0.02	4.0	MTB93050W
22.5x17.5	572x445	20.25x15.12	514x384	6	152	.97	0.027	4.0	MTB93060W
22.5x17.5	572x445	20.25x15.12	514x384	8	203	1.32	0.037	5.25	MTB93080W
22.5x17.5	572x445	20.25x15.12	514x384	12	305	2.03	0.057	6.67	MTB93120W

*Loading height restrictions when using covers or stacking totes.

White Tote Dividers — {16.64}

For Tote Box	Size	Part No.	Max. Dividers per Tote
MTB91035W	Short	MDS91035NAT	7
MTB91035W	Long	MDL91035NAT	5
MTB92035W	Short	MDS92035NAT	11
MTB92035W	Long	MDL92035NAT	7
MTB92050W	-	MDS92035NAT	11
MTB92060W	Short	MDS92060NAT	11
MTB92060W	Long	MDL92060NAT	7
MTB93030W	Short	MDS93030NAT	15
MTB93030W	Long	MDL93030NAT	11
MTB93060W	Short	MDS93060NAT	15
MTB93060W	Long	MDL93060NAT	11
MTB93080W	Short	MDS93080NAT	15
MTB93080W	Long	MDL93080NAT	11
MTB93120W	Short	MDS93120NAT	15
MTB93120W	Long	MDL93120NAT	11



Natural Polypropylene dividers are used in Super-White totes.

Card Holders — {16.65}

Includes snaps to fit all Metro totes. ESD Benstat also available.

Material	Holds Card Size (mm)		Carton Qty.*	Est. Carton Wt. (lbs.)	Cat. No.
Benstat	5x8	127x203	96	10	OP2501BAS
Benstat	3x5	76x129	96	10	OP2535BAS
Polypropylene	5x8	127x203	96	10	OP2501CLR
Polypropylene	3x5	76x129	96	10	OP2535CLR

*Items must be purchased in carton quantities to avoid a broken lot charge.
Pricing based on quantity ordered. Please consult your Metro representative.



Tote Boxes (shown with Cardholder)

Bulk Supply Tub — Nesting

Ruggedly constructed, perfect for storing large bulky items.

Part No.	Outside Dimension (in.) Length / Width / Height		Outside Dimension (mm) Length / Width / Height	
MB34240G	24.5	19	622	483

Note: Bins are available in carton quantities only. Bins above are priced per each but must be ordered in multiples of carton quantity.



MB34240G



**Take
advantage
of every
square inch.**



qwikTRAK™
Top-Track™

SECURITY, TRACK & SEISMIC SHELVING

Security, Track & Seismic Shelving.....94-117
 Security Shelving.....96-99
 High-Density Track Shelving 100-110
 Vertical Extra-High Shelving..... 111
 Seismic Shelving 112-117

SECURITY SHELVING



SEC55C shown with optional Super Adjustable intermediate shelves.

Super Erecta® Shelf Stationary Security — {14.01}
66.81" (1695mm) high

- Double Door: Doors open 270 degrees and can be secured along sides.
- Shipped Knocked-Down: Saves on freight costs. Easily assembled.



LEARN MORE

Width (in.)	Length (in.)	Fits Shelf (in.)	Cat. No. Chrome	Cat. No. Metroseal Green with Microban®	Cat. No. Stainless Steel
21.5	546	38.5 980 18x36 457x914	SEC33C	SEC33K3	SEC33S
21.5	546	50.5 1295 18x48 457x1219	SEC35C	SEC35K3	SEC35S
27.25	692	38.5 980 24x36 610x914	SEC53C	SEC53K3	SEC53S
27.25	692	50.5 1295 24x48 610x1219	SEC55C	SEC55K3	SEC55S
27.25	692	62.5 1587 24x60 610x1524	SEC56C	SEC56K3	SEC56S
33.5	851	38.5 980 30x36 760x914	SEC63C		SEC63S
33.5	851	50.5 1295 30x48 760x1219	SEC65C		SEC65S
33.5	851	62.5 1587 30x60 760x1524	SEC66C		SEC66S



SECURITY ASSEMBLY



SEC55DC shown with optional Super Adjustable intermediate shelves (sold separately). Doors open 270° and can be secured to the sides of the cart.

Super Erecta® Mobile Security — {14.01}

Standard-Duty Stem Caster Models — Chrome & Metroseal Green Include 5" (127mm) casters.

Caster Type	Width (in.)	Length (in.)	Fits Shelf (in.)	Cat. No. Chrome	Cat. No. Metroseal Green with Microban®
(2) 5MP/(2) 5MPB	21.5 546	40.75 1035	18x36 457x914	SEC33EC	SEC33EK3
(2) 5MP/(2) 5MPB	21.5 546	52.75 1340	18x48 457x1219	SEC35EC	SEC35EK3
(4) 5MP	27.25 692	40.75 1035	24x36 610x914	SEC53DC	SEC53DK3
(4) 5MP	27.25 692	52.75 1340	24x48 610x1219	SEC55DC	SEC55DK3
(4) 5MP	27.25 692	65 1651	24x60 610x1524	SEC56DC	SEC56DK3
(2) 5MP/5MPB	27.25 692	40.75 1035	24x36 610x914	SEC53EC	SEC53EK3
(2) 5MP/5MPB	27.25 692	52.75 1340	24x48 610x1219	SEC55EC	SEC55EK3
(2) 5MP/5MPB	27.25 692	65 1651	24x60 610x1524	SEC56EC	SEC56EK3
(2) 5PC/5PCB	27.25 692	40.75 1035	24x36 610x914		SEC53VK3
(2) 5PC/5PCB	27.25 692	52.75 1340	24x48 610x1219		SEC55VK3
(2) 5PC/5PCB	27.25 692	65 1651	24x60 610x1524		SEC56VK3
(2) 5MP/(2) 5MPB	33.5 851	40.75 1035	30x36 760x914	SEC63EC	
(2) 5MP/(2) 5MPB	33.5 851	52.75 1340	30x48 760x1219	SEC65EC	
(2) 5MP/(2) 5MPB	33.5 851	65 1651	30x60 760x1524	SEC66EC	

Casters: 5MP and 5MPB (with locking brake) feature a polyurethane tread. 5PC and 5PCB (with locking brake) casters feature a polymer horn and resist rusting. They are recommended for high moisture environments. Large casters can create a tipping hazard. On security units using 18" (457mm) deep shelving, do not use casters larger than 5" (127mm) in diameter.

Overall height: Models with 5MP casters – 67.94" (1726mm) high Models with 5PC casters – 68.44" (1739mm) high



SEC55LC shown with optional Super Adjustable intermediate shelves.

Heavy-Duty Models — Chrome & Metroseal Green — {14.01}
68.44" (1739mm) high

Chrome and Metroseal Green models feature aluminum dollies with wraparound bumpers and 5" (127mm) diameter casters.

Caster Type	Width (in.)	Length (in.)	Fits Shelf (in.)	Cat. No. Chrome	Cat. No. Metroseal Green with Microban®
(2) BSP/BSPB	28.06 713	38.5 980	24x36 610x914	SEC53LC	SEC53LK3
(2) BSP/BSPB	28.06 713	50.5 1285	24x48 610x1219	SEC55LC	SEC55LK3
(2) BSP/BSPB	28.06 713	63.13 1600	24x60 610x1524	SEC56LC	SEC56LK3



SECURITY SHELVING

Standard-Duty Stem Caster Models — Stainless Steel — {14.01} 62" (1575mm) high

Casters must be ordered separately. See pages 58-59, or consult your Metro representative for the proper caster for your application. Intermediate shelves are not included with base models and must be ordered separately.

Description	Width		Length		Fits Shelf		Cat. No. Stainless Steel
	(in.)	(mm)	(in.)	(mm)	(in.)	(mm)	
Standard Duty	21.5	546	40.75	1035	18x36	457x914	SEC33S-SD
Standard Duty	21.5	546	52.75	1340	18x48	457x1219	SEC35S-SD
Standard Duty	27.25	692	40.75	1035	24x36	610x914	SEC53S-SD
Standard Duty	27.25	692	52.75	1340	24x48	610x1219	SEC55S-SD
Standard Duty	27.25	692	65	1651	24x60	610x1524	SEC56S-SD
Standard Duty	33.5	851	40.75	1035	30x36	760x914	SEC63S-SD
Standard Duty	33.5	851	52.75	1340	30x48	760x1219	SEC65S-SD
Standard Duty	33.5	851	65	1651	30x60	760x1524	SEC66S-SD

Note: Given height is for unit without casters. For approximate overall unit height add chosen caster diameter plus 1" (25mm). Large casters can create a tipping hazard. On security units using 18" (457mm) deep shelving, do not use casters larger than 5" (127mm) in diameter.

Heavy-Duty Models — Stainless Steel — {14.01} 62" (1575mm) high

Heavy-duty stainless steel models include staked posts for use with standard Metro dollies. Dolly bases and plate casters must be ordered separately. See pages 60-61, or consult your Metro representative for the proper caster for your application. Intermediate shelves are not included with base models and must be ordered separately.

Description	Width		Length		Fits Shelf		Cat. No. Stainless Steel
	(in.)	(mm)	(in.)	(mm)	(in.)	(mm)	
Heavy Duty	28.06	713	38.5	980	24x36	610x914	SEC53S-HD
Heavy Duty	28.06	713	50.5	1285	24x48	610x1219	SEC55S-HD
Heavy Duty	28.06	713	63.13	1600	24x60	610x1524	SEC56S-HD

Note: Given height is for unit without a Metro dolly or casters.
 Note: To calculate the actual height of the unit using plate casters: 62" [1575mm] + .25" [6mm] for dolly + load height of the caster (found on page 61).
 Dolly bases are recommended for applications where security units will be transported over the road. Please consult your Metro representative for the appropriate casters and accessories for these applications.

Super Erecta Security Modules — {14.01}

Convert a standard 24" (610mm) wide unit into a security module with this convenient kit.

- Used to enclose one or more areas of a unit.
- Fits between shelves spaced 20" (510mm) apart on any Super Erecta Shelving unit.
- Adapts to 24" (610mm) wide shelves in 30", 48" and 60" (760, 1219 and 1524mm) lengths.

Width/Length	Height	Cat. No. Chrome	Cat. No. Stainless Steel		
				(in.)	(mm)
24x30	610x760	20	510	SECM2430NC	SECM2430NS
24x48	610x1219	20	510	SECM2448NC	*
24x60	610x1524	20	510	SECM2460NC	*

Note: Security Module consists of side panels, back panels and door. Posts and shelves sold separately, see page 48. When multiple security modules are stacked on one shelving unit, separate top and bottom shelves are still necessary for each module.
 Security modules must be used with Super Erecta Shelf wire shelves.
 *Consult your Metro representative for availability.

Units DO NOT include intermediate shelves.
 Intermediate shelves must be ordered separately.

Intermediate Shelves for Super Erecta Security Units

Shelf Size W x L	Cat. No. Chrome	Cat. No. Stainless Steel
18x36	A1836NC	A1836NS
18x48	A1848NC	A1848NS
24x36	A2436NC	A2436NS
24x48	A2448NC	A2448NS
24x60	A2460NC	A2460NS
30x36	A3036NC	A3036NS
30x48	A3048NC	A3048NS
30x60	A3060NC	A3060NS

Shelf Size W x L	Cat. No. Metroseal Green	Cat. No. Super Erecta Pro
18"x36	A1836NK3	PR1836NK3
18"x48	A1848NK3	PR1848NK3
24"x36	A2436NK3	PR2436NK3
24"x48	A2448NK3	PR2448NK3
24"x60	A2460NK3	PR2460NK3
30"x36	A3036NK3	PR3036NK3
30"x48	A3048NK3	PR3048NK3
30"x60	A3060NK3	PR3060NK3

Note: Standard Super Erecta shelves can also be used as intermediate shelves. Refer to page 48 for more information.

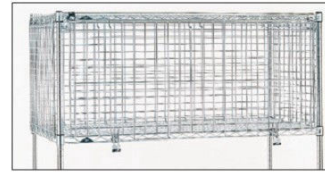

SECM2430NC
 Assembled on Shelving Unit

Most popular Chrome Security Units with (2) intermediate shelves included.

Easy Order with one Part #

Depth x Width x Height	Description	Cat. No.	
			(in.)
24 x 36 x 74	609 x 914 x 1879	Mobile	SEC53C-4
24 x 48 x 74	609 x 1219 x 1879	Mobile	SEC55C-4
24 x 60 x 74	609 x 1524 x 1879	Mobile	SEC56C-4
24 x 36 x 74	609 x 914 x 1879	Stationary	SEC53EC-4
24 x 48 x 74	609 x 1219 x 1879	Stationary	SEC55EC-4
24 x 60 x 74	609 x 1524 x 1879	Stationary	SEC56EC-4



NSF Security Units are NSF Rated

1.800.992.1776 • WWW.METRO.COM

97

SECURITY SHELVING



Shown with optional intermediate shelves (not included)

Clips snap easily into slots along post length to support shelves.

Units DO NOT include intermediate shelves.
Intermediate shelves must be ordered separately.

qwikSLOT® Security Units — {14.01}

Add/Remove-A-Shelf Feature: Allows the unit to quickly adapt to your changing storage needs.

Security with easier to adjust shelves.

qwikSLOT Stationary Security

Width (in.)	Width (mm)	Actual Length (mm)		Height (mm)		Fits Shelf (mm)		Approx. Pkd. Wt. (lbs./kg)		Cat. No. Chrome
		(in.)	(mm)	(in.)	(mm)	(in.)	(mm)	(lbs.)	(kg)	
21.5	546	38.5	980	66.81	1695	18x36	457x914	138	63	SEC33CQ
21.5	546	50.5	1283	66.81	1695	18x48	457x1219	157	71	SEC35CQ
27.25	705	38.5	980	66.81	1695	24x36	610x914	154	70	SEC53CQ
27.25	705	50.5	1283	66.81	1695	24x48	610x1219	174	79	SEC55CQ
27.25	705	62.5	1587	66.81	1695	24x60	610x1524	195	89	SEC56CQ

Intermediate Shelves for qwikSLOT Security Units

Width (in.)	Width (mm)	Length (mm)		Cat. No. Chrome
		(in.)	(mm)	
18	457	36	914	1836QBR
18	457	48	1219	1848QBR*
24	610	36	914	2436QBR*
24	610	48	1219	2448QBR*
24	610	60	1524	2460QBR

*Chrome qwikSLOT shelves sizes: 18x36, 18x48, 24x36, and 24x48 (457x914, 457x1219, 610x914, 610x1219, and 610x1524).
**Drop Mat qwikSLOT shelves with 1" (25mm) ledge available sizes: 24x36, 24x48 (610x914, 610x1219).

qwikSLOT Mobile Security

Standard-Duty Stem Caster Models: feature 5" (127mm) swivel casters. Please note model numbers for specific caster types.

Caster Type	Width (in.)	Width (mm)	Actual Length (mm)		Height (mm)		Fits Shelf (mm)		Approx. Pkd. Wt. (lbs./kg)		Cat. No. Chrome
			(in.)	(mm)	(in.)	(mm)	(in.)	(mm)	(lbs.)	(kg)	
(2) 5MP/5MPB	21.5	546	40.75	1035	67.94	1726	18x36	457x914	146	66	SEC33ECQ
(2) 5MP/5MPB	21.5	546	52.75	1340	67.94	1726	18x48	457x1219	165	75	SEC35ECQ
(4) 5MP	27.25	692	40.75	1035	67.94	1726	24x36	610x914	162	74	SEC53DCQ
(4) 5MP	27.25	692	52.75	1340	67.94	1726	24x48	610x1219	182	83	SEC55DCQ
(4) 5MP	27.25	692	65	1651	67.94	1726	24x60	610x1524	203	92	SEC56DCQ
(2) 5MP/5MPB	27.25	692	40.75	1035	67.94	1726	24x36	610x914	162	74	SEC53ECQ
(2) 5MP/5MPB	27.25	692	52.75	1340	67.94	1726	24x48	610x1219	182	83	SEC55ECQ
(2) 5MP/5MPB	27.25	692	65	1651	67.94	1726	24x60	610x1524	203	92	SEC56ECQ

Casters: 5MP* and 5MPB* (with locking brake) feature a polyurethane tread. 5PC and 5PCB* (with locking brake) casters feature a polymer horn and resist rusting. They are recommended for high moisture environments.
NOTE: Large casters can create a tipping hazard. On 18" (457mm) security units, do not use casters larger than 5" (127mm) in diameter.

Heavy-Duty qwikSlot Mobile Security

Feature aluminum dollies with wraparound bumpers and 5" (127mm) diameter casters.

Caster Type	Width (in.)	Width (mm)	Actual Length (mm)		Height (mm)		Fits Shelf (mm)		Cat. No. Chrome
			(in.)	(mm)	(in.)	(mm)	(in.)	(mm)	
(2) 5BP/5BPB	28.06	713	38.5	980	68.44	1739	24x36	610x914	SEC53LCQ
(2) 5BP/5BPB	28.06	713	50.5	1283	68.44	1739	24x48	610x1219	SEC55LCQ
(2) 5BP/5BPB	28.06	713	63.13	1600	68.44	1739	24x60	610x1524	SEC56LCQ



qwikSLOT Locking Clip

Recommended for mobile applications. Must be used with 9985QS shelf clips. (Package of 4)
Cat. No. 9985QSL



SECURITY SHELVING

Corrosion resistance, removable shelf mats & antimicrobial protection at all touch-points.

MetroMax Q Security Units — {14.01}

- Heavy gauge open wire construction.
- Microban antimicrobial product protection is built into the enclosures, doors, handles, and shelves.
- Optional intermediate shelves: MetroMax Q quick adjust shelves or corrosion proof MetroMax i.
- Ergonomic 1/4-turn door handle: Doors open 270 degrees and can be secured along sides.

MetroMax Q Stationary Units — 66.19" (1681mm) High

Actual Outside Dimensions				Fits Shelf		Cat. No.
Width (in.)	Length (in.)	Width (mm)	Length (mm)	(in.)	(mm)	
26.94	685	38.88	987	24x36	610x914	MQSEC53E
26.94	685	50.88	1292	24x48	610x1219	MQSEC55E
26.94	685	62.88	1597	24x60	610x1524	MQSEC56E

Note: Leveling foot on post can be adjusted up to 1" (25mm) to compensate for uneven floors.

MetroMax Q Stem Caster Mobile Units — 67.81" (1723mm) High

Models include four 5" (127mm) diameter casters with polyurethane tread; two swivel and two swivel with brakes.

Actual Outside Dimensions (Including Bumpers and Handle)				Fits Shelf		Cat. No. Includes Casters with Plated Finish	Cat. No. Includes Corrosion Resistant Polymer Casters
Width (in.)	Length (in.)	Width (mm)	Length (mm)	(in.)	(mm)		
27.81	707	40.75	1035	24x36	610x914	MQSEC53DE	MQSEC53VE
27.81	707	52.75	1340	24x48	610x1219	MQSEC55DE	MQSEC55VE
27.81	707	64.75	1645	24x60	610x1524	MQSEC56DE	MQSEC56VE

**"DE" models use two 5MPX and two 5MPBX casters.
***"VE" models use two 5PCX and two 5PCBX casters. Recommended for wet or damp environments.



MQSEC53VE with optional intermediate shelves



Ergonomic 1/4-turn door handle

MetroMax Q Heavy-Duty Mobile Units — 68.5" (1740mm) High

Mounted on aluminum dolly with 5" (127mm) plate casters and wraparound bumpers.

Actual Outside Dimensions (Including Handle)				Fits Shelf		Approx. Pkd. Wt.		Cat. No.
Width (in.)	Length (in.)	Width (mm)	Length (mm)	(in.)	(mm)	(lbs.)	(kg)	
28.06	713	39.13	994	24x36	610x914	166	75	MQSEC53LE
28.06	713	51.13	1299	24x48	610x1219	176	80	MQSEC55LE
28.06	713	63.13	1603	24x60	610x1524	179	81	MQSEC56LE

Note: The aluminum dollies used on the LE models have two B5P and two B5PB plate casters.



Intermediate Shelves for MetroMax Q Security

Width (in.)		Length (in.)		i	i	Q
(mm)	(mm)	(mm)	(mm)	Cat. No. Shelf with Grid Mat	Cat. No. Shelf with Solid Mat	Cat. No. Shelf with Grid Mat
24	610	36	914	MX2436G	MX2436F	MQ2436G
24	610	48	1220	MX2448G	MX2448F	MQ2448G
24	610	60	1524	MX2460G	MX2460F	MQ2460G

Units DO NOT include intermediate shelves.
Intermediate shelves must be ordered separately.

Standard Units consist of top and bottom wire shelves, tri-lobal adapters, steel posts, wire enclosures, and doors. Casters are included with mobile units.

HIGH-DENSITY TRACK SHELVING — QWIKTRAK™



GET ON TRACK. THE ULTIMATE STORAGE METHOD.



THE SECRET
TO MAXIMIZING
STORAGE IS THE
**ACTIVE
AISLE**
CONCEPT.

qwikTRAK Floor Track Systems

- ✓ Perfect for heavy loads.
- ✓ Smooth Gliding – Tracks protect floors from wear.
- ✓ Floor tracks compensate for rough floors.
- ✓ Aluminum & stainless track construction.



Double-Deep Configurations can be created where two systems are joined together to increase the overall depth of the storage system for even greater storage capacity.

qwikTRAK (Both single- and double-deep systems) can be used with Metro wire shelving (Super Erecta or Super Adjustable Super Erecta) and polymer shelving systems (MetroMax i and MetroMax Q). MetroMax 4 can be used on single-deep systems.

100

1.800.992.1776 • WWW.METRO.COM



HIGH-DENSITY TRACK SHELVING — TOP-TRACK™

BOOST STORAGE SPACE BY UP TO 50% WITH NO ADDED CONSTRUCTION COSTS.

TB TrackBuilder

The easiest way to build track shelving.

Top-Track Overhead Track Systems



- ✓ Floors are easy to clean.
- ✓ Easy Access – Roll carts in & out of the aisles.
- ✓ Ideal for uneven floor surfaces.
- ✓ All-polymer options available.



ADA Compliant

Top-Track (single deep) can be used with Metro wire shelving (Super Erecta or Super Adjustable Super Erecta) and polymer shelving systems (MetroMax i, MetroMax 4 and MetroMax Q).

Double-Deep configurations can be created when two systems are joined together to increase the overall depth of the storage system for even greater storage capacity. Double-Deep Top-Track is only available for Super Erecta and Super Adjustable Super Erecta style shelving.

HIGH-DENSITY STORAGE — QWIKTRAK™



qwikTRAK Storage System — {11.15}

Super Erecta, Super Erecta Pro, Super Adjustable, MetroMax Q, MetroMax i, MetroMax 4



Getting started:

Document the available floor space

- Actual length: Nominal track length + the nominal width of each end unit + 3" (76mm)
- Actual width: Nominal Shelf length + 3.5" (89mm)
- Actual height of a mobile qwikTRAK unit is: Nominal post height + 4.5" (115mm)

It is recommended that the tracks are installed at least 2" (52mm) from the wall.

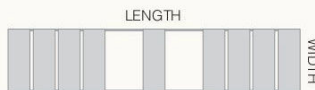

Shelves Sold Separately: All end, intermediate, and mobile units must be 18" (457mm) or wider. Each stationary end and intermediate unit must have a minimum of four shelves. Super Adjustable shelves may be used for all tiers.

Stationary End Unit Kit (Choose one kit for each system)
Includes 74" high posts (1880mm) high stationary posts, and hardware necessary for connecting stationary end units to tracks. Shelves are sold separately.

Super Erecta, Super Erecta Pro, Super Adjustable Super Erecta				MetroMax Q Steel Posts	MetroMax Polymer Posts
Cat. No. Chrome Plated	Cat. No. Metroseal Green	Cat. No. Metroseal Gray	Cat. No. Stainless Steel	Cat. No.	Cat. No.
BTEC	BTEK3	BTEK4	BTES	BTEQ3	BTEX3



Stationary Intermediate Units

Required when overall desired track length exceeds 21' (6405mm). Optional when track length is under 21' (6405mm). Includes 74" high posts (1880mm) high stationary posts, and hardware necessary for connecting one stationary intermediate unit to tracks. Shelves are sold separately.

Super Erecta, Super Erecta Pro, Super Adjustable Super Erecta				MetroMax Q Steel Posts	MetroMax Polymer Posts
Cat. No. Chrome Plated	Cat. No. Metroseal Green	Cat. No. Metroseal Gray	Cat. No. Stainless Steel	Cat. No.	Cat. No.
BTAC	BTAK3	BTAK4	BTAS	BTAQ3	BTAX3



Mobile Units

(One kit required per mobile unit)
Includes four 74" (1880mm) high mobile posts, four casters, donut bumpers, and other hardware to assemble a mobile unit. Shelves are sold separately.

Under normal conditions, aisle width of 30"-36" (760-914mm) is recommended. The storage of very large objects within the system, however, may require an aisle width larger than 36" (914mm).

Super Erecta, Super Erecta Pro, Super Adjustable Super Erecta				MetroMax Q Steel Posts	MetroMax Polymer Posts
Cat. No. Chrome Plated	Cat. No. Metroseal Green	Cat. No. Metroseal Gray	Cat. No. Stainless Steel	Cat. No.	Cat. No.
BTAC	BTAK3	BTAK4	BTAS	BTAQ3	BTAX3



Note: Casters feature an acetyl grooved wheel. Chrome plated (BTMC) includes casters with plated steel components. BTMK3/BTMS/BTMQ3/BTMX3 include casters with stainless

Track Sets

Includes tracks and hardware needed to assemble track runs up to 21' (6400mm).

Length (ft.)	Length (mm)	Cat. No.	Length (ft.)	Length (mm)	Cat. No.
2.5	762	BTS2.5NA	14	4267	BTS14NA
6	1828	BTS6NA	15	4572	BTS15NA
7	2135	BTS7NA	16	4877	BTS16NA
8	2440	BTS8NA	17	5182	BTS17NA
9	2743	BTS9NA	18	5486	BTS18NA
10	3048	BTS10NA	19	5791	BTS19NA
11	3352	BTS11NA	20	6096	BTS20NA
12	3657	BTS12NA	21	6400	BTS21NA
13	3962	BTS13NA			

Note: BTS2.5NA includes a joining kit to connect the tracks to other track sets.

The easiest way to build qwikTRAK.

- Notes:**
1. qwikTRAK is available with 74" posts (1880mm) as standard. Requests for TALLER posts must be reviewed by Metro Engineering. For applications requiring posts SHORTER than 74" (1880mm), contact your Metro representative.
 2. Existing Metro Super Erecta, Super Adjustable, MetroMax Q, and MetroMax i shelving units can be retrofitted as part of a qwikTRAK installation.
 3. Weight capacities for standard qwikTRAK: Super Erecta, Super Adjustable, MetroMax Q systems are designed to hold up to 2,000 lbs. (907kg) per shelving unit. MetroMax i stationary units can hold up to 2,000 lbs. (907kg). MetroMax i mobile units can hold up to 1,200 lbs. (544g) per unit. MetroMax 4 stationary units can hold up to 2,000 lbs. (907kg); MetroMax 4 mobile units can hold up to 800 lbs. (363kg) per unit.
 4. Added rigidity for heavily loaded systems. Super Erecta standard adjustment shelves provide the most rigid wire shelving mobile units. Recommended when configuring systems using 60" and 72" long shelves subject to the heaviest loads and frequent movement (multiple times daily). MetroMax Q epoxy coated steel posts may be used with MetroMax i shelves for added rigidity when managing sensitive packaged items and heavier unit loads; steel posts are corrosion resistant.



HIGH-DENSITY STORAGE — QWIKTRAK™ DOUBLE DEEP

Double-Deep qwikTRAK Storage System — {11.15a}

Super Erecta, Super Erecta Pro, Super Adjustable, MetroMax Q, MetroMax i, MetroMax 4

Getting started:

Document the available floor space

- Actual length: Nominal track length + the nominal width of each end unit + 3" (76mm)
- Actual width: Nominal Shelf length + 3.5" (89mm)
- Actual height of a mobile qwikTRAK unit is: Nominal post height + 4.5" (115mm)

It is recommended that the tracks are installed at least 2" (52mm) from the wall.

Shelves Sold Separately: All end, intermediate, and mobile units must be 18" (457mm) or wider. Each stationary end and intermediate unit must have a minimum of four shelves. Super Adjustable shelves may be used for all tiers.

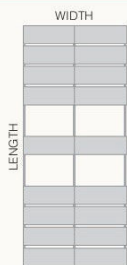

Stationary End Unit Kit (Choose One per double-deep System)

Includes 74" high posts (1880mm) high stationary posts, and hardware necessary for connecting stationary end units to tracks. Shelves are sold separately

Super Erecta, Super erecta Pro, Super Adjustable Super Erecta				MetroMax Q Steel Posts	MetroMax Polymer Posts
Cat. No. Chrome Plated	Cat. No. Metroseal Green	Cat. No. Metroseal Gray	Cat. No. Stainless Steel	Cat. No.	Cat. No.
LBTEC	LBTEK3	LBTEK4	LBTES	LBTEQ3	LBTEX3

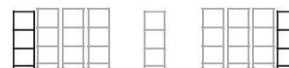

Stationary Intermediate Units

Includes 74" high posts (1880mm) high stationary posts and hardware necessary for connecting one double-deep stationary intermediate unit to tracks and anchoring tracks to the floor. Shelves are sold separately.

Super Erecta, Super erecta Pro, Super Adjustable Super Erecta				MetroMax Q Steel Posts	MetroMax Polymer Posts
Cat. No. Chrome Plated	Cat. No. Metroseal Green	Cat. No. Metroseal Gray	Cat. No. Stainless Steel	Cat. No.	Cat. No.
LBTAC	LBTAK3	LBTAK4	LBTAS	LBTAQ3	LBTAX3



Mobile Units (One kit required per Double-Deep Mobile Unit)

Includes (8) 74" (1880mm) high -UP posts, (4) V-groove casters, (1) stainless steel center channel caster assembly, donut bumpers, Tie Bar Brackets, and other hardware. Shelves are sold separately.

Shelf Width (in) (mm)	Super Erecta, Super erecta Pro, Super Adjustable Super Erecta				MetroMax Q Steel Posts	MetroMax Polymer Posts
	Cat. No. Chrome Plated	Cat. No. Metroseal Green	Cat. No. Metroseal Gray	Cat. No. Stainless Steel	Cat. No.	Cat. No.
18 457	LBTM18C	LBTM18K3	LBTM18K4	LBTM18S	LBTM18Q3	LBTM18X3
21 530	LBTM21C	LBTM21K3	LBTM21K4	LBTM21S	LBTM21Q3	—
24 610	LBTM24C	LBTM24K3	LBTM24K4	LBTM24S	LBTM24Q3	LBTM24X3

Note: Casters feature acetyl grooved wheel. Chrome kit includes casters with steel components. Metroseal Green / Stainless Steel / MetroMax Q / MetroMax i kits include casters with stainless components.

Under normal conditions, aisle width of 30"-36" (762-914mm) is recommended. The storage of very large objects within the system, however, may require an aisle width larger than 36" (914mm).



Track Sets Includes tracks and hardware needed to assemble Double-Deep qwikTRAK up to 21' (6400mm).

Length (ft.) (mm)	Cat. No.	Length (ft.) (mm)	Cat. No.
2.5 762	LBTS2.5NA	14 4267	LBTS14NA
6 1829	LBTS6NA	15 4572	LBTS15NA
7 2135	LBTS7NA	16 4877	LBTS16NA
8 2440	LBTS8NA	17 5182	LBTS17NA
9 2743	LBTS9NA	18 5486	LBTS18NA
10 3048	LBTS10NA	19 5791	LBTS19NA
11 3352	LBTS11NA	20 6096	LBTS20NA
12 3657	LBTS12NA	21 6400	LBTS21NA
13 3962	LBTS13NA		

Note: LBTS2.5NA includes a joining kit to connect the tracks to other track sets.



The easiest way to build qwikTRAK.

Notes:

1. qwikTRAK is available with 74" posts (1880mm) as standard. Requests for TALLER posts must be reviewed by Metro Engineering. For applications requiring posts SHORTER than 74" (1880mm), contact your Metro representative.
2. Maximum allowable shelf length for use with a double-deep system is 60" (1524mm).
3. The maximum width of a double-deep configuration is 10'6" (3200mm). (i.e., two systems, each having 60" (1524mm) long shelves, plus 6" (150mm) for qwikTRAK components.
4. Weight capacities: Double Deep Mobile Units — Super Erecta/Super Adjustable, Super Erecta/MetroMax Q: 3,000 lbs. (1364kg) evenly distributed. MetroMax i: 1,800 lbs. (818kg) evenly distributed. Stationary End and Intermediate Units — Each end and intermediate double deep unit consists of two independent stationary shelving units positioned side by side. Each shelving unit has a maximum weight capacity of 2,000 lbs. (907kg).

1.800.992.1776 • WWW.METRO.COM

103

HIGH-DENSITY POLYMER STORAGE — TOP-TRACK™



THE ONLY ALL-POLYMER SHELVING

strong enough for overhead track systems.



The easiest way to build Top-Track.





HIGH-DENSITY POLYMER STORAGE — TOP-TRACK™

Top-Track Storage System — {9.29}

Polymer Shelving — MetroMax i, MetroMax 4, MetroMax Q



Getting started:

Document the available floor space

- Actual length: Nominal track length + the nominal width of each end unit + 2" (51mm)
- Actual width: Nominal Shelf length + 3.5" (89mm)
- Actual height of system is approx. 87" (2210mm)

It is recommended that the tracks are installed at least 5" (127mm) from the wall.

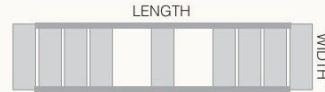

The system compensates for uneven floor surfaces. Floor should be smooth and free from large cracks or raised obstacles. Maximum load capacity for mobile units is 900 lbs. (400kg).

Stationary End Unit Kit (Order one per Top-Track system)

Includes hardware and components to connect track sets to two stationary end units. 86" (2185mm) posts included. Shelves are ordered separately.

Fits Shelf Width (in.) (mm)	Polymer Posts Cat. No. End Unit Kit	Epoxy Coated Steel Posts Cat. No. End Unit Kit
18	MXTTE18	MQTTE18
21	MXTTE21	MQTTE21
24	MXTTE24	MQTTE24



Stationary Intermediate Unit Kit

Required when overall desired track length exceeds 21' (6405mm). Optional when track length is under 21' (6405mm). Includes 86" high posts (2184mm) high stationary posts, and hardware necessary for connecting one stationary intermediate unit to tracks. Shelves are sold separately.

Fits Shelf Width (in.) (mm)	Polymer Posts Cat. No. Intermediate Unit Kit	Epoxy Coated Steel Posts Cat. No. Intermediate Unit Kit
18	MXTTA18	MQTTA18
21	MXTTA21	MQTTA21
24	MXTTA24	MQTTA24



Mobile Unit Kit (Order one per mobile unit)

Kit includes 74" (1880mm) posts, rigid casters, caster channels, bumpers, and roller assemblies. Shelves are sold separately.

Fits Shelf Width (in.) (mm)	Polymer Posts Cat. No. with Plated Casters	Polymer Posts Cat. No. with Stainless Casters	Epoxy Coated Steel Posts Cat. No. with Plated Casters	Epoxy Coated Steel Posts Cat. No. with Stainless Casters
18	MXTTM18C	MXTTM18S	MQTTM18C	MQTTM18S
21	MXTTM21C	MXTTM21S	MQTTM21C	MQTTM21S
24	MXTTM24C	MXTTM24S	MQTTM24C	MQTTM24S

Under normal conditions, aisle width of 30"-36" (760-914mm) is recommended. The storage of very large objects within the system, however, may require an aisle width larger than 36" (914mm).



Track Sets (One track set is required between stationary units)

Includes necessary sections of track for assembling track runs of 6' to 21' (1830-6405mm).

Length (feet)	Length (mm)	Approx. Pkd. Wt.		Cat. No.	Length (feet)	Length (mm)	Approx. Pkd. Wt.		Cat. No.
		(lbs.)	(kg)				(lbs.)	(kg)	
2.5	762	15	6.8	TTS2.5NA	14	4267	98	44.1	TTS14NA
6	1828	40.5	18.2	TTS6NA	15	4572	106.5	47.9	TTS15NA
7	2135	47.5	21.3	TTS7NA	16	4877	113.5	51	TTS16NA
8	2440	56	25.2	TTS8NA	17	5182	121	54.4	TTS17NA
9	2743	62.5	28.1	TTS9NA	18	5486	128	51.6	TTS18NA
10	3048	69.5	31.2	TTS10NA	19	5791	135	60.7	TTS19NA
11	3353	76.5	34.4	TTS11NA	20	6096	142	63.9	TTS20NA
12	3657	83.5	37.5	TTS12NA	21	6400	149	67	TTS21NA
13	3962	92	41.4	TTS13NA					

Note: TTS2.5NA includes a joining kit to connect the tracks to longer track sections.

Notes:

1. Mobile, stationary end, and intermediate units must have a minimum of 4 shelves.
2. Mobile Units: If 18" (457mm) wide mobile units are planned, the maximum allowable size shelf is 60" (1524mm) long. If 18" (457mm) wide by 60" (1524mm) long mobile units are planned, a maximum of five 18" (457mm) mobile units are allowable between two stationary units. 18" (457mm), 21" (530mm) and 24" (610mm) wide mobile units can be intermixed in a given system. The standard system requires 74" (1880mm) posts on the mobile units. Recommended maximum load rating for a mobile unit is 900 lbs. (410kg).
3. To accommodate bumpers, the actual size of a mobile unit is 2.5" (63.5mm) wider than the shelf width shown. For example, an 18"(457mm) wide unit is actually 20.5" (521mm).
4. MetroMax Q epoxy coated steel posts may be used with MetroMax i shelves for added rigidity; steel posts are corrosion resistant.

HIGH-DENSITY WIRE STORAGE — TOP-TRACK™



Top-Track Storage System — {11.12}

Wire Shelving — Super Erecta, Super Erecta Pro, Super Adjustable



Super Erecta® Top-Track®

Getting started:

Document the available floor space

- Actual length: Nominal track length + the nominal width of each end unit + 2" (51mm)
- Actual width: Nominal Shelf length + 3.5" (89mm)
- Actual height of system is approx. 87" (2210mm)

It is recommended that the tracks are installed at least 5" (127mm) from the wall.



Shelves Sold Separately: All end, intermediate, and mobile units must be 18" (457mm) or wider. Each stationary end and intermediate unit must have a minimum of four shelves. Super Adjustable shelves may be used for all tiers.

Stationary End Unit Kits (One kit is required per single system)
Includes hardware necessary for connecting stationary end units to track. 86" (2185mm) posts are included. Shelves sold separately.

Shelf Width (in) (mm)	Cat. No. Chrome Plated	Cat. No. Metroseal Green	Cat. No. Metroseal Gray	Cat. No. Stainless Steel
18 457	TTE18C	TTE18K3	TTE18K4	TTE18S
21 530	TTE21C	TTE21K3	TTE21K4	TTE21S
24 610	TTE24C	TTE24K3	TTE24K4	TTE24S



Stationary Intermediate Units

Required when overall desired track length exceeds 21' (6405mm). Optional when track length is under 21' (6405mm). Includes 86" high posts (2184mm) high stationary posts, and hardware necessary for connecting one stationary intermediate unit to tracks. Shelves are sold separately.

Shelf Width (in) (mm)	Cat. No. Chrome Plated	Cat. No. Metroseal Green	Cat. No. Metroseal Gray	Cat. No. Stainless Steel
18 457	TTA18C	TTA18K3	TTA18K4	TTA18S
21 530	TTA21C	TTA21K3	TTA21K4	TTA21S
24 610	TTA24C	TTA24K3	TTA24K4	TTA24S



Mobile Unit Kits

Kit includes special 74" (1880mm) posts, casters/caster channels, donut bumpers, and roller bearing assemblies. Shelves are sold separately.

Shelf Width (in) (mm)	Overall Width (in) (mm)	Cat. No. Chrome Plated	Cat. No. Metroseal Green	Cat. No. Metroseal Gray	Cat. No. Stainless Steel
18" 457	20 1/4 514	TTM18C	TTM18K3	TTM18K4	TTM18S
21 530	23 1/4 590	TTM21C	TTM21K3	TTM21K4	TTM21S
24 610	26 1/4 667	TTM24C	TTM24K3	TTM24K4	TTM24S

Note: Casters feature wheels with polyurethane tread. Chrome plated kits include casters with plated steel components. Metroseal and Stainless Steel kits include casters with stainless steel components.

Under normal conditions, aisle width of 30"-36" (760-914mm) is recommended. The storage of very large objects within the system, however, may require an aisle width larger than 36" (914mm).

* If 18" wide mobile units are planned, the maximum allowable length shelf is 60" (1524mm) long. If 18" (457mm) wide by 60" (1524mm) long mobile units are planned, a maximum of five 18" (457mm) mobile units are allowable between two stationary units. 18" (457mm), 21" (530mm), 24" (610mm) wide mobile units can be intermixed in a given system.



Track Sets Includes tracks and hardware needed to assemble runs up to 21' (6400mm).

Length (ft.) (mm)	Cat. No.	Length (ft.) (mm)	Cat. No.
2.5 762	TTS2.5NA	14 4267	TTS14NA
6 1828	TTS6NA	15 4572	TTS15NA
7 2135	TTS7NA	16 4877	TTS16NA
8 2440	TTS8NA	17 5182	TTS17NA
9 2743	TTS9NA	18 5486	TTS18NA
10 3048	TTS10NA	19 5791	TTS19NA
11 3352	TTS11NA	20 6096	TTS20NA
12 3657	TTS12NA	21 6400	TTS21NA
13 3962	TTS13NA		

Note: TTS2.5NA includes a joining kit to connect the tracks to other track sets.

The easiest way to build Top-Track.

Additional Notes:

- To accommodate bumpers, the actual size of a mobile unit is 2.5" (63.5mm) wider than the shelf width shown. For example, an 18" (457mm) wide unit is actually 20.5" (52mm).
- Recommended maximum load rating for a mobile unit is 900 lbs. (410kg). Floor should be level, smooth, and free from large cracks and raised obstacles.
- Added rigidity for heavily loaded systems. Super Erecta standard adjustment shelves provide the most rigid wire shelving mobile units. Recommended when configuring systems using 60" (1524mm) and 72" (1829mm) long shelves subject to the heaviest loads and frequent movement (multiple times daily).





HIGH-DENSITY WIRE STORAGE — TOP-TRACK™

Easy Order with one Part #.

Get all you need to create efficient high-density storage under one simple part number.

10ft. Fits spaces 10ft. and over

Complete System Length (ft./in.)	System Width (mm)	System Width (in.)	Chrome Top-Track		Super Erecta Pro Top-Track	
			Easy Order Model	Easy Order Model	Easy Order Model	Easy Order Model
9' 7"	2921	48	1219	TT10-E2148M1848C	TT10-E2148M1848P	
9' 7"	2921	60	1524	TT10-E2160M1860C	TT10-E2160M1860P	

Models Contain

(1) 6" Track Set, (8) 86" Posts, (1) 18" Tie Bar End Kit, (8) 74" Top Trk Mobile Posts, (2) 18" Mobile Kits, (16) Shelves

Note: Chrome systems use chrome posts and plated casters. SE Pro uses Metroseal Green Posts and Stainless casters.



21" (530mm) End Width
18" (457mm) Mobile Width
48" (1219mm) or 60" (1524mm) Shelf Length

12ft. Fits spaces 12ft. and over

Complete System Length (ft./in.)	System Width (mm)	System Width (in.)	Chrome Top-Track		Super Erecta Pro Top-Track	
			Easy Order Model	Easy Order Model	Easy Order Model	Easy Order Model
11' 7"	3531	48	1219	TT12-E2448M1848C	TT12-E2448M1848P	
11' 7"	3531	60	1524	TT12-E2460M1860C	TT12-E2460M1860P	

Models Contain

(1) 7.5" Track Set, (8) 86" Posts, (1) 18" Tie Bar End Kit, (12) 74" Top Trk Mobile Posts, (3) 18" Mobile Kits, (20) Shelves

Note: Chrome systems use chrome posts and plated casters. SE Pro uses Metroseal Green Posts and Stainless casters.



24" (610mm) End Width
18" (457mm) Mobile Width
48" (1219mm) or 60" (1524mm) Shelf Length

14ft. Fits spaces 14ft. and over

Complete System Length (ft./in.)	System Width (mm)	System Width (in.)	Chrome Top-Track		Super Erecta Pro Top-Track	
			Easy Order Model	Easy Order Model	Easy Order Model	Easy Order Model
13' 7"	4140	48	1219	TT14-E2448M1848C	TT14-E2448M1848P	
13' 7"	4140	60	1524	TT14-E2460M1860C	TT14-E2460M1860P	

Models Contain

(1) 9.5" Track Set, (8) 86" Posts, (1) 18" Tie Bar End Kit, (16) 74" Top Trk Mobile Posts, (4) 18" Mobile Kits, (24) Shelves

Note: Chrome systems use chrome posts and plated casters. SE Pro uses Metroseal Green Posts and Stainless casters.



24" (610mm) End Width
18" (457mm) Mobile Width
48" (1219mm) or 60" (1524mm) Shelf Length

16ft. Fits spaces 16ft. and over

Complete System Length (ft./in.)	System Width (mm)	System Width (in.)	Chrome Top-Track		Super Erecta Pro Top-Track	
			Easy Order Model	Easy Order Model	Easy Order Model	Easy Order Model
15' 7"	4750	48	1219	TT16-E2448M2448C	TT16-E2448M2448P	
15' 7"	4750	60	1524	TT16-E2460M2460C	TT16-E2460M2460P	

Models Contain

(1) 11.5" Track Set, (8) 86" Posts, (1) 18" Tie Bar End Kit, (16) 74" Top Trk Mobile Posts, (4) 18" Mobile Kits, (24) Shelves

Note: Chrome systems use chrome posts and plated casters. SE Pro uses Metroseal Green Posts and Stainless casters.



24" (610mm) End Width
24" (610mm) Mobile Width
48" (1219mm) or 60" (1524mm) Shelf Length

The numbers don't lie...

30%
More Storage.

Conventional 16' of Storage



16' of Top-Track Storage



HIGH-DENSITY WIRE STORAGE — TOP-TRACK™ DOUBLE DEEP



Double-Deep Top-Track Storage System — {11.12a}

Wire Shelving — Super Erecta, Super Erecta Pro, Super Adjustable

Stationary End Units (One kit required for entire double deep configuration)
Includes hardware necessary for connecting stationary end units in double-deep systems and connecting to an overhead track set. 86" (2185mm) posts included. Shelves sold separately.

Shelf Width (in.) (mm)	Approx. Pkd. Wt. (lbs.) (kg)	Cat. No. Chrome-Plated
18 457	33 14.8	LTTE18C
21 530	37 16.6	LTTE21C
24 610	41 18.4	LTTE24C



Stationary Intermediate Units (One kit required for Intermediate units connected end-to-end) Includes hardware necessary for connecting intermediate units in double-deep systems and connecting to an overhead track set on each side. 86" (2185mm) posts included.

Shelf Width (in.) (mm)	Approx. Pkd. Wt. (lbs.) (kg)	Cat. No. Chrome-Plated
18 457	18 8	LTTA18C
21 530	20 9	LTTA21C
24 610	22 9.9	LTTA24C



Mobile Unit Kits (One kit required per mobile unit)

Includes posts, casters, caster channels, donut bumpers, roller bearing assemblies, and tie-together hardware to connect two mobile units.

Shelf Width (in.) (mm)	Overall Width (in.) (mm)	Approx. Pkd. Wt. (lbs.) (kg)	Cat. No. Chrome-Plated
18 457	20 1/4 514	72 32.4	LTTM18C
21 530	23 1/4 590	75 33.7	LTTM21C
24 610	26 1/4 667	78 35	LTTM24C



Track Sets Includes necessary sections of track for assembling track runs up to 21' (6400mm). For track sizes within the even 1-foot (305mm) increments, contact your Metro representative. Only one track set is required between stationary units.

Length (feet) (mm)	Approx. Pkd. Wt. (lbs.) (kg)	Cat. No.	Length (feet) (mm)	Approx. Pkd. Wt. (lbs.) (kg)	Cat. No.
2.5 762	15 6.8	TTS2.5NA	14 4267	98 44.1	TTS14NA
6 1828	40.5 18.2	TTS6NA	15 4572	106.5 47.9	TTS15NA
7 2135	47.5 21.3	TTS7NA	16 4877	113.5 51	TTS16NA
8 2440	56 25.2	TTS8NA	17 5182	121 54.4	TTS17NA
9 2743	62.5 28.1	TTS9NA	18 5486	128 51.6	TTS18NA
10 3048	69.5 31.2	TTS10NA	19 5791	135 60.7	TTS19NA
11 3353	76.5 34.4	TTS11NA	20 6096	142 63.9	TTS20NA
12 3657	83.5 37.5	TTS12NA	21 6400	149 67	TTS21NA
13 3962	92 41.4	TTS13NA			

Note: TTS2.5NA includes a joining kit to connect the tracks to longer track sections.

Notes:

- Each stationary end and intermediate unit **must** have a minimum of four shelves. For all Super Adjustable applications, the top and bottom shelves must be non "quick adjust" Super Erecta shelves.
- The standard Double Deep Top-Track system requires the use of 86" (2185mm) posts (i.e., 86P) on the stationary end and intermediate units. **Shelves for the stationary end and intermediate units are sold separately.**
- The mobile unit kits include special 74" (1880mm) posts with casters. **Shelves for mobile units are sold separately.**
- Under normal conditions, an aisle width of 30"-36" (760-914mm) is recommended. The storage of very large objects within the system, however, may require an aisle width larger than 36" (914mm).
- Two intermediate shelving units connected end-to-end are required when the track length exceeds 21 feet (6400mm). Stationary intermediate shelving units may be used at the discretion of the user when track lengths are less than 21 feet (6400mm).
- The maximum Double Deep system configuration is 106" (3200mm) (i.e., two systems, each having 60" (1524mm) long shelves, plus 6" (150mm) for Top-Track components).
- Ease of reliability for the mobile units is an important consideration in evaluating Top-Track as a possible storage alternative. The floor should be level, smooth, and free from large cracks and raised obstacles. Two mobile shelving units connected end-to-end and loaded with between 800 to 1,200 lbs. (365-550kg) will require a human effort range (in lbs. of human force) of between 18-24 lbs. (8-11kg) to move the unit from a complete stop. Subjectively, an average 110 lb. (50kg) person will perceive this as acceptable effort levels. For loads over 1,200 lbs. (550kg), contact your Metro representative.
- Mobile units should have the top shelf positioned as close as possible to the track.
- To accommodate bumpers, the actual size of a mobile unit is 2.5" (63.5mm) wider than the shelf width shown. For example, an 18" (457mm) wide unit is actually 20.5" (52mm).
- To calculate the overall length of a Super Erecta Top Track System, add the following:
Nominal track length + Nominal widths of each end unit + 1.5" (38mm).

Getting started:
Document the available floor space
 • Actual length: Nominal track length + the nominal width of each end unit + 2" (51mm)
 • Actual width: Nominal Shelf length + 3.5" (89mm)
 • Actual height of system is approx. 87" (2210mm)
It is recommended that the tracks are installed at least 5" (127mm) from the wall.

The easiest way to build Top-Track.

Note: for other finishes please contact your Metro representative.
 For Top-Track accessories, see page 110.



HIGH-DENSITY SEISMIC WIRE STORAGE — TOP-TRACK™

Seismic Top-Track® Single Length System

End Unit Kit:

Includes four shelves, four staked posts, bracket bars, sway braces (for top, back, and end), anchor plates, foot plates, tubular braces, clamps, and assembly hardware.

Description	Cat. No.
Kit for 48" (1219mm) Stationary End Unit	SA48TTS
Kit for 54" (1370mm) Stationary End Unit	SA54TTS
Kit for 60" (1524mm) Stationary End Unit	SA60TTS

Strut Kit:

Description	Cat. No.
Kit for 48" (1219mm) Wide Unit	TTB48STRUT
Kit for 54" (1370mm) Wide Unit	TTB54STRUT
Kit for 60" (1524mm) Wide Unit	TTB60STRUT

Note: Floor anchoring hardware not included.

Example: For a complete "Single-Length Top-Track System," the following would be required: Two Stationary End Units, One Track Set (11-foot [3355mm] maximum), One Center Strut (if track length exceeds 7 feet), Mobile Units.

Note: Posts and shelves are included in the end and intermediate unit kits. Shelves are sold separately for the mobile unit.

Add track sets and mobile unit kits, refer to page 106.

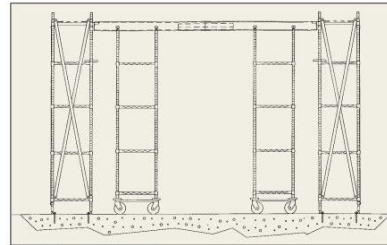

Single-Length System

Seismic Top-Track® Double Length System

End Unit Kits:

Includes four shelves, four staked posts, bracket bars, sway braces (for top, back, and end), anchor plates, foot plates, tubular braces, clamps, and assembly hardware.

Description	Cat. No.
Kit for 48" (1219mm) Stationary End Unit	SA48TTS
Kit for 54" (1370mm) Stationary End Unit	SA54TTS
Kit for 60" (1524mm) Stationary End Unit	SA60TTS

Intermediate Unit Kits:

Includes eight shelves, eight staked posts, bracket bars, sway braces (for top, back, and end), anchor plates, foot plates, tubular braces, clamps, and assembly hardware.

Description	Cat. No.
Kit for 48" (1219mm) Stationary Intermediate Unit	SA48TTIS
Kit for 54" (1370mm) Stationary Intermediate Unit	SA54TTIS
Kit for 60" (1524mm) Stationary Intermediate Unit	SA60TTIS

Strut Kit:

Description	Cat. No.
Kit for 48" (1219mm) Wide Unit	TTB48STRUT
Kit for 54" (1370mm) Wide Unit	TTB54STRUT
Kit for 60" (1524mm) Wide Unit	TTB60STRUT

Note: Floor anchoring hardware not included.

Example: For a complete "Double-Length Top-Track System," the following would be required: Two Stationary End Units, Two Track Sets* (11-foot [3355mm] maximum), One Intermediate Unit, Two Center Struts (if track length exceeds 7 feet [2135mm]), Mobile Units.*

Note: Posts and shelves are included in the end and intermediate unit kits. Shelves are sold separately for the mobile unit.

Notes:

- Each installation must have two stationary end units for a single-track length of 7' (2135mm) to 11' (3355mm).
- A center strut is required for each track section over 7' (2135mm).
- For track lengths over 11' (3355mm), an intermediate unit is required, thus creating a double-length system.
- Seismic Top-Track is based upon a weight-loading capacity of 25 lbs. (11kg) per square foot on a four-shelf stationary and mobile units, with maximum of 900 lbs. (408kg) per mobile unit. Additional shelves may be added, but are limited to a maximum load of 25 lbs. (11kg) per cubic foot per unit.
- A maximum of four 21" (640mm) or 24" (610mm), or five 18" (457mm) mobile units are allowed per an 11' (3355mm) track length, with no more than a 900 lb. (408kg) weight capacity per mobile unit.
- Stationary End Units are available in 24"x48" (610x1219mm), 24"x54" (610x1370mm), and 24"x60" (610x1524mm).
- Seismic Top-Track design is based on the use of HR concrete, at least 5.5" (140mm) thick, with a compressive strength of 3,000 psi (211kg/cm). Anchorage is not included.
- To calculate the overall length of a Super Erecta Top Track System, add the following: Nominal track length + Nominal widths of each end unit + 1.5" (38mm).

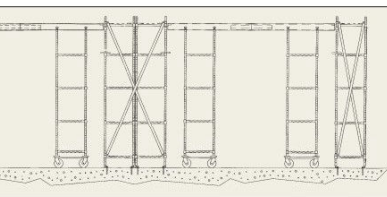

Double-Length System

Add track sets and mobile unit kits, refer to page 106.

See page 112 for Stationary Seismic shelving.

Notes:

- Floor anchors are not included. The structural engineer of record must verify that the anchorage bolt and building structure are adequate for the applied load.
- For Seismic Top-Track, the highest load shelf must be no more than 60" (1524mm) from the floor.
- For Seismic Top-Track, a unit must have no more than four loaded shelves within 60" (1524mm) height.
- If a fifth shelf is used, it must serve only as a cover and not be used for load bearing.
- Each shelving unit, whether single or "back-to-back," cannot connect to other shelving units or walls.

TOP-TRACK™ & QWIKTRAK™ ACCESSORIES



Top-Track™ Floor Pad Protectors — {9.29} {11.12}

Use for both MetroMax Top-Track and Super Erecta Top-Track Systems.

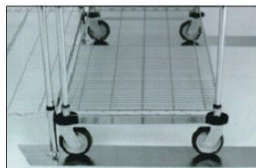

Top-Track® Floor Protectors

For Track Length (ft.)	(mm)	Cat. No.	For Track Length (ft.)	(mm)	Cat. No.
6	1828	FPS6N	14	4267	FPS14N
7	2135	FPS7N	15	4572	FPS15N
8	2440	FPS8N	16	4877	FPS16N
9	2743	FPS9N	17	5182	FPS17N
10	3048	FPS10N	18	5486	FPS18N
11	3353	FPS11N	19	5791	FPS19N
12	3657	FPS12N	20	6096	FPS20N
13	3962	FPS13N	21	6400	FPS21N



Top-Track® Wall Mount Bracket

Top-Track™ Wall Mount Bracket — {11.12}

Used to attach one set of tracks to the wall. Eliminates the need for a stationary end unit. Includes one pair of wall brackets and hardware to attach tracks to the wall brackets. Hardware to attach the wall brackets to the wall is NOT included.

Cat. No. TTWM



Top-Track® Stop Plate Kit

Top-Track™ Stop Plate Kit — {11.12}

Used in conjunction with the Wall Mount Bracket Kit. The stop plates bolt to the underside of the track next to the wall brackets to prevent the mobile units from bumping into the wall.

Cat. No. TTSTP

Metro Tip:

Floor pad protectors compensate for soft flooring materials by protecting the floor from wear and tear. For new construction projects, it is recommended that flooring of suitable durability is used in areas where Top-Track will be installed.



qwikTRAK Stop Plate Kit

qwikTRAK Stop Plate Kit — {11.15}

Eliminates the need for a stationary end unit. The kit contains two "L-shaped" stop plates that mount to the ends of the floor tracks. The stop plates prevent a mobile unit from rolling off the end of the tracks.

Cat. No. BTSP

Consult your Metro representative for guidance on configuring a qwikTRAK system using this kit.

Stop plates (kit of two) shown mounted to the end plates on the floor tracks.



HI-RISE SHELVING

EFFICIENCY IS ON THE RISE

Short on floor space?
Try going vertical.



Super Erecta Hi-Rise Shelving

Super Erecta® Hi-Rise Shelving — {10.17}

- For light-duty storage applications where floor space is at a premium.
- Construct shelving up to 24 feet (7315mm) high — 3 times the height of conventional shelving
- Metro's computerized engineering system assures correct specifications and load rating of Hi-Rise materials for your application.

All Hi-Rise installations must be reviewed and approved by Metro Engineering. Hi-Rise certification plate supplied. Only Super Erecta and Super Adjustable Super Erecta wire shelves can be used in Hi-Rise applications. Contact Metro customer service or your local Metro representative for details.

Metro Tip:

One frequently overlooked opportunity to gain additional storage capacity is the efficient use of vertical space. By connecting Super Erecta posts, storage areas may be created that utilize every available cubic foot of unused vertical air space.

Material part numbers will be provided by Metro Product Development upon review of application.

1.800.992.1776 • WWW.METRO.COM

111

SEISMIC SHELVING - HCAI (OSHPD) PREAPPROVAL



Strength, it's what we stand for.

Metro® Seismic Shelving HCAI (OSHPD) Preapproval provides certified components for securing Metro shelving in active seismic zones.

Metro's exclusive patented design is intended for a facility to save thousands in engineering fees, by achieving preapproval on seismic project plans. Metro's design takes those savings a step further.

The Metro Seismic Shelving options have earned an HCAI (The Department of Health Care Access and Information) or OSHPD (Office of Statewide Health Planning and Development) preapproval driven by the state of California specific to projects subject to the 2019 California Building Code (CBC).



SEISMIC WIRE ASSEMBLY



Metro Super Erecta®
Stand-alone unit



MetroMax® i
Stand-alone unit



SEISMIC POLYMER ASSEMBLY



SEISMIC SHELVING - HCAI (OSHPD) PREAPPROVAL

HCAI Preapproval Base Plate Kits — {10.15}

Description	Approx Pkg. Wt. (lbs.)	Wt. (kg)	Cat. No.
1-post, 2-3 bolt triangular plate kit	9.8	4.4	SABP13BR-4PK
1-post, 4-bolt square plate kit	12.5	5.7	SABP14BR-4PK
2-post, 5-bolt rectangular plate kit	10.8	4.9	SABP25BR-2PK
4-post, 6 bolt plate square bolt kit	8.4	3.8	SABP46BR-1PK

Note: These base plate kits must be used with the HCAI (OSHPD) Preapproval posts and cannot be retrofitted to standard posts or staked posts.

SABP13BR-4PK
1-post, 2-3 bolt triangular plate kit includes:

- (4) chromate-plated base plates, each with a single post socket
- (1) bag of four clevis pins and four cotter pins
- (4) hole covers
- (2) seismic labels
- (2) SES label holders.

SABP14BR-4PK
1-post, 4-bolt, square plate kit includes:

- (4) chromate-plated base plates, each with a single post socket
- (1) bag of four clevis pins and four cotter pins
- (2) seismic labels
- (2) SES label holders.

SABP25BR-2PK
2-post, 5 bolt rectangular plate kit includes:

- (2) chromate-plated base plates, each with two post sockets
- (1) bag of four clevis pins and four cotter pins
- (2) seismic labels
- (2) SES label holders.

SABP46BR-1PK
4-post, 6-bolt plate, square bolt kit includes:

- (1) chromate plated base plate with 4 post sockets
- (1) bag of four clevis pins and four cotter pins
- (2) seismic labels
- (2) SES label holders.

HCAI Preapproval Posts & Post Clamps — {10.15}

Required for use with Base Plate Kits.

Super Erecta Post: Chrome plated, 1" (25mm) diameter posts with a welded insert and seismic leveler bolt.

MetroMax Post: Steel post with a welded insert and a seismic leveler bolt. Epoxy-coated finish with Microban antimicrobial product protection over a chromate substrate. Seismic bolt is chromate-plated steel.

Post Clamps: Stainless steel. There are versions for Super Erecta posts and MetroMax posts.

Seismic Leveler Bolt: Chromate-plated steel.

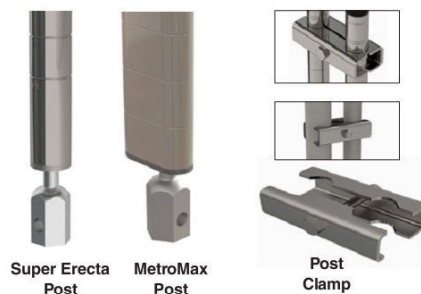

Super Erecta® and Super Adjustable Super Erecta®

Cat. No.	Description	Nominal Height		Actual Height		Actual width		Approx Pkd. Weight	
		(in.)	(mm)	(in.)	(mm)	(in.)	(mm)	(lbs.)	(kg)
SA63P	Seismic HCAI Preapproval 63" Chrome Plated Post	63	1600	63.6250	1616	1	25	4.0	1.8
SA74P	Seismic HCAI Preapproval 74" Chrome Plated Post	74	1880	75.6875	1922	1	25	4.8	2.2
SA86P	Seismic 86" Chrome Plated Post	86	2185	87.6875	2227	1	25	5.5	2.5
SAPCLAMP	Seismic HCAI Preapproval Stainless Steel Post Clamp for Super Erecta			1.1250	29			0.7	0.3

NOTE: 86" posts (SA86P) can be used to earn site specific approvals using the OPM# 0426 base plates and post clamps.

MetroMax® i and MetroMax® Q

Cat. No.	Description	Nominal Height		Actual Height		Actual width		Approx Pkd. Weight	
		(in.)	(mm)	(in.)	(mm)	(in.)	(mm)	(lbs.)	(kg)
SAMQ63PE	Seismic HCAI Preapproval MetroMax 63" Post	63	1600	62.6250	1591	1.5	38	4.4	2.0
SAMQ74PE	Seismic HCAI Preapproval MetroMax 74" Post	74	1880	74.6250	1895	1.5	38	4.9	2.2
SAMQ86PE	Seismic HCAI Preapproval MetroMax 86" Post	86	2185	86.6250	2200	1.5	38	5.7	2.6
SAPCLAMPX	Seismic HCAI Pre-approved Stainless Steel Post Clamp for MetroMax			1.1250	29			0.6	0.3

Reference these spec sheets for shelves: Super Erecta (10.01), Super Adjustable (10.01A), MetroMax i (9.20), MetroMax Q (9.21).

SEISMIC SHELVING - HCAI (OSHPD) PREAPPROVAL



**Configurations
for Super Erecta
& MetroMax
Shelving**

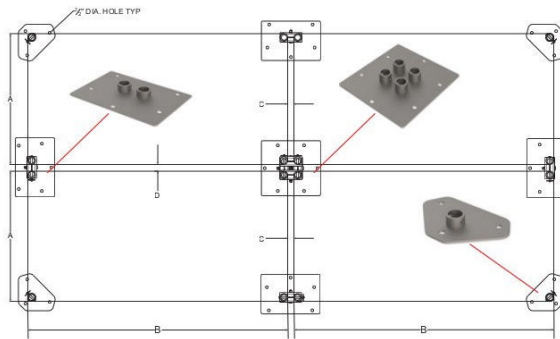
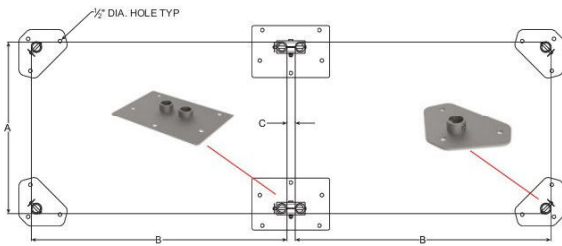
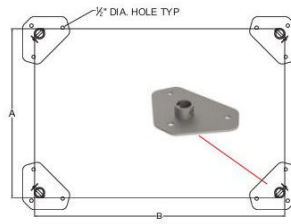

Super Erecta® and Super Adjustable Super Erecta® Installations.

Dimensions	Super Erecta / Super Adjustable
A	18", 21", 24" (457, 530, 620mm)
B	23-3/4" thru 71-3/4" (603 - 1822mm)
C	1-5/32" (29mm)
D	1-5/32" (29mm)

MetroMax® Q Installations.

Dimensions	MetroMax Q
A	18", 21", 24" (457, 530, 620mm)
B	23-1/2" thru 71-1/2" (597 - 1816mm)
C	1-7/32" (31mm)
D	1-1/4" (32mm)

MetroMax® i Installations.

Dimensions	MetroMax i
A	18", 24" (457, 620mm)
B	23-9/16" thru 71-9/16" (598 - 1816mm)
C	1-5/32" (29mm)
D	1-1/4" (32mm)



SEISMIC SHELVING - HCAI (OSHPD) PREAPPROVAL

A secure mounting connection combined with robust Metro shelving.

- Low profile base plates.
- No drilling of posts.
- Flexible hardware placement
- Easy to install.
- Easy to level.



HCAI
OSHPD
OPM-0426

HCAI (OSHPD) Preapproval **OPM-0426** specifically outlines the configuration requirements for HCAI (OSHPD) governed healthcare facilities in the state of California subject to the 2019 California Building Codes. (Note: These requirements may vary in different jurisdictions.)

The HCAI0 Preapproval outlines the following:

Weight Loads (for installations subject to HCAI Preapproval)

20 PSF/tier for a shelving unit. The maximum load bearing of a shelving unit is defined as a five tier unit with four storage tiers and an open top shelf (no load).

Example 1: 24x48x74, 4-tier unit. Maximum load bearing per shelf is 20 lbs. x 8 sq ft = 160 lbs. The total unit is rated using this formula: 4 tiers x 160 lbs. per tier = 640 lbs.

Example 2: 24x48x74, 6-tier unit. Maximum load bearing per 24x48 unit is 640 lbs. A 6-tier unit is defined to have 5 storage tiers. and an open top shelf. 640 lbs. / 5 tiers = 128 lbs. per tier.

Positioning of bottom shelf: maximum of 10" (254mm) from the floor.

Seismic Zones are called out within OPM-0426.

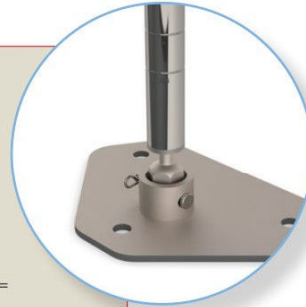

Anchorage Bolts: Metro does not provide the concrete floor anchorage bolts. The engineer of record for a site specific job must verify that the building structure is adequate for the applied load.

Supporting Information can be found on Metro.com

- HCAI (OSHPD) Preapproval Document OPM-0426. OPM stands for HCAI Preapproval of Manufacturer's Certification.
- Calculations: Please contact your Metro representative.

SEISMIC SHELVING - SITE APPROVAL



Metro® Seismic Shelving for site approvals.

- This offering utilizes staked posts and foot plates with a single anchor hole.
- Sway braces are REQUIRED for qwikSLOT shelving units and are OPTIONAL for Super Erecta.
- Prior to purchasing these accessories please note: Metro recommends reviewing these options with the local structural engineer on your construction project to earn site approval



Super Erecta with SAFP foot plates

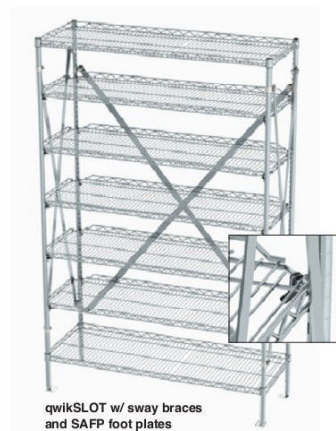

qwikSLOT w/ sway braces and SAFP foot plates

Staked Seismic Posts

- Staked post insert at the base for use with SAFP threaded seismic foot plates.
- Ordered as EACH.
- Seismic foot plates are ordered separately.

Nominal Post Height (in.) (mm)	Actual Post Height with Seismic Foot Installed (in.) (mm)		Approx. Pkd. Wt. (lbs.) (kg)		SES Chrome Cat. No.	SES Metroseal Green Cat. No.	SES Metroseal Gray Cat. No.	SES Stainless Cat. No.	qwikSLOT Chrome Cat. No.		
	63	1600	62	625	1591	3.5	1.6	63P-STKD	63PK3-STKD	63PK4-STKD	63PS-STKD
74	1880	74	6875	1897	4.0	1.8	74P-STKD	74PK3-STKD	74PK4-STKD	74PS-STKD	74SAPQ
86	2184	86	6875	2202	5.0	2.3	86P-STKD	*	*	*	*

NOTE: Staked posts replace older seismic post models with staked inserts (63SAP, 74SAP).
NOTE: Contact your Metro representative for availability of 86" staked posts.



Staked Post



x4

Threaded Seismic Foot Plate Kit

ONE kit needed per shelving unit

- Kit includes four chromate plated threaded foot plates.
- Each foot plate includes a 0.687" (17mm) diameter anchor hole.
- Dimensions: 2.25" x 2.25" (57 x 57mm)

Threaded Seismic Foot Plate Kit
Cat No. SAFP
Use one kit per unit



Wall Brackets

- Optional chrome plated brackets for connecting wire shelving or Super Erecta Pro shelving to the wall for added stability.

Wall Brackets
Cat No. 9984C
Use one kit per unit



Super Erecta Single Unit

- (4) Super Erecta Shelves
- (4) staked posts
- (1) SAFP



SEISMIC QWIKSLOT SHELVING - SITE APPROVAL

Configuring Single qwikSLOT Shelving Units

Sway Brace End Kit - TWO are used per single unit.

- Includes braces that form an "X" on one side of the unit.

For Shelf Depth (in.) mm		Approx. Pkd. Wt. (lbs.) (kg)		Cat. No.
18 & 21	457 & 530	6.0	2.7	SA18EC
24	610	6.1	2.8	SA24EC



qwikSLOT Locking Clips Cat No. 9985QSL

Use one kit per qwikSLOT shelf



Sway Brace Back Kit - ONE is used per single unit.

- Includes braces that form an "X" along the shelf length (back side).

For Shelf Length (in.) mm		Approx. Pkd. Wt. (lbs.) (kg)		Cat. No.
24 & 30	457 & 760	6.1	2.8	SA24EC
36	914	9.0	4.1	SA36BC
42	1060	9.2	4.2	SA42BC
48 & 54	1219 & 1370	9.8	4.4	SA48BC
60	1524	10.0	4.5	SA60BC



Sway Brace Back Kit

qwikSLOT Single Unit

- (2) Super Erecta Shelves
- (5) qwikSLOT Drop Mat shelves
- (5) 9985QSL locking clips
- (4) qwikSLOT seismic staked posts
- (2) Sway Brace End Kits
- (1) Sway Brace Back Kit
- (1) SAFP

NOTE: qwikSLOT locking clips & sway braces are **REQUIRED**.

Configuring Back-to-Back qwikSLOT Shelving Units

Seismic Post Clamps

- Used to connect units together for greater stability.
- Each kit contains six post clamps.
- REQUIRED for each pair of back-to-back units.

qwikSLOT Back-to-Back Unit

- (4) Super Erecta Shelves
- (10) qwikSLOT Shelves
- (10) 9985QSL locking clips
- (8) qwikSLOT seismic staked posts
- (2) Sway Brace End Kits
- (1) Sway Brace Back Kit
- (2) SAFP
- (1) SAPC (post clamp kit)



Seismic Post Clamps Cat No. SAPC

Use one kit per unit

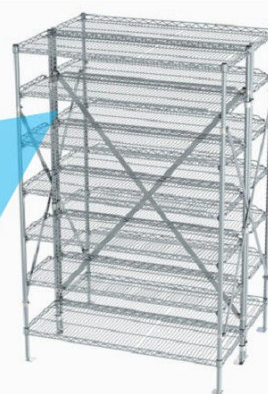

NOTE: qwikSLOT locking clips & sway braces are **REQUIRED**.

Sway Brace End Kit - TWO are used per back-to-back unit.

Includes braces that form an "X" on one side of the unit.

For Combined Shelf Depths		Approx. Pkd. Wt. (lbs.) (kg)		Cat. No.
Two 18" Depth.		9.0	4.1	SA36BC
One 18" & One 21" Depth				
Two 21" Depth		9.2	4.2	SA42BC
One 18" & One 24" Depth				
One 21" & One 24" Depth				
Two 24" Depth		9.8	4.4	SA48BC

Sway Brace Back Kit - ONE is used per back-to-back unit.

Includes braces that form an "X" along the shelf length (back side).

For Shelf Length (in.) mm		Approx. Pkd. Wt. (lbs.) (kg)		Cat. No.
24 & 30	610 & 760	6.1	2.8	SA24EC
36	914	9.0	4.1	SA36BC
42	1060	9.2	4.2	SA42BC
48 & 54	1219 & 1370	9.8	4.4	SA48BC
60	1524	10.0	4.5	SA60BC



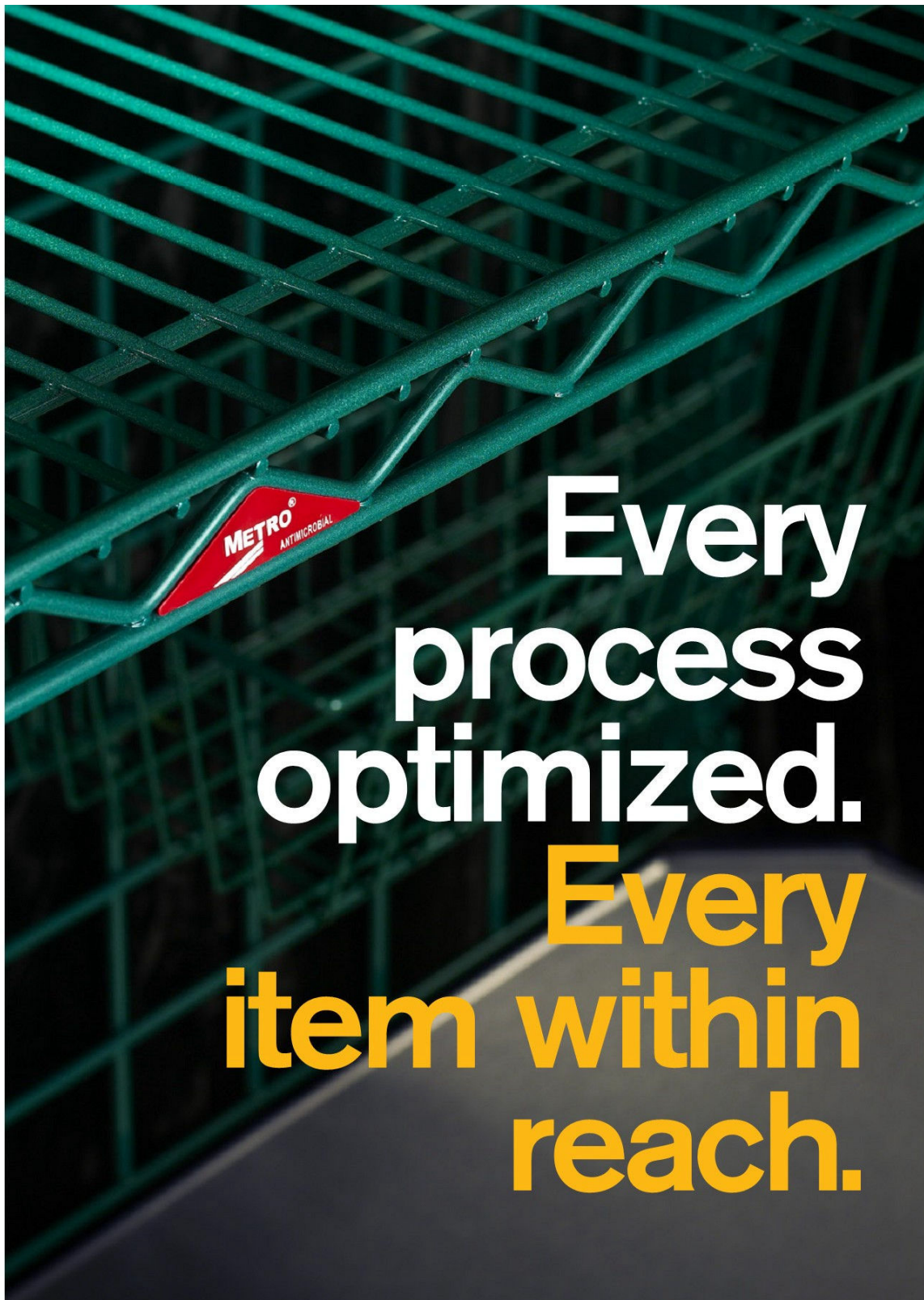

**Every
process
optimized.**

**Every
item within
reach.**



SmartWall®

WALL SHELVING

Wall Shelving	118-130
SmartWall Grid & Wall Shelving	120-127
Wall Mounted Shelving	128-130

SMARTWALL® PRODUCTIVITY SYSTEM



Wall-to-wall efficiency.

A unique storage and workstation system for often underutilized wall space.

Perfect for:

- Prep Areas
- Storage Rooms
- Janitorial Supply
- Above Sinks, Worktables or Equipment



120

1.800.992.1776 • WWW.METRO.COM



SMARTWALL® PRODUCTIVITY SYSTEM



Green Metroseal Epoxy Finish with Microban



Gray Metroseal Epoxy Finish with Microban

Flexible, Robust Design:

Wall tracks and uprights are designed to interface with wood studs, plywood, concrete, and other suitable wall structures.

Easy to Adapt:

Uprights and grid brackets can be easily repositioned along the track before being fastened to the wall. Shelves and accessories are easy to add and remove.

Easy to Install:

Once the tracks are installed level, shelving and task stations can be quickly configured.

Easy to Clean:

Shelves, shelf supports, and grids can easily be removed for thorough cleaning of walls. Wall tracks and uprights can easily be wiped clean.

Durable Finishes:

Super Erecta with Metroseal Green & Gray epoxy finishes for all environments with built-in Microban® antimicrobial product protection.

1.800.992.1776 • WWW.METRO.COM

SMARTWALL® PRODUCTIVITY SYSTEM



Easy Order Starter Kits

Medium-Duty Task Station — {10.42b}**Cat. No. SWK36-1**

(1) Wall Track, (2) Uprights (1) Super Erecta Shelf, (2) Single Shelf Supports, (1) Wire Grid

Overall dimensions: 40" L x 31¹/₄" H (1016 x 793mm)

Shelf Size: 18" x 36" (457 x 914mm)

Grid Size: 18" x 36" (457 x 914mm)

**Standard-Duty Task Station — {10.42b}****Cat. No. SWK36-2**

(1) Wall Track, (2) Grid Brackets (1) Grid Shelf, (1) Wire Grid

Overall dimensions: 40" L x 39¹/₁₆" H (1016 x 1008mm)

Shelf Size: 18" x 36" (457 x 914mm)

Grid Size: 30" x 36" (762 x 914mm)



Easy Order Accessory Packs

Accessory Pack Sink — {10.42b}**Cat. No. SWA1**

(1) Wire Basket, (1) Lid Holder, (1) Utensil Cylinder, (1) Cylinder Holder, (2) Prong Hooks, (6) Standard Hooks

Accessories fit: 18" x 36" (457 x 914mm) of grid space



Wire Grid and Grid Brackets Not Included.

Accessory Pack Prep — {10.42b}**Cat. No. SWA2**

(1) Small Shelf, (1) Wire Basket, (1) Bin Holder, (1) Small Bin, (2) Prong Hooks, (6) Standard Hooks

Accessories fit: 18" x 36" (457 x 914mm) of grid space



Wire Grid and Grid Brackets Not Included.



SMARTWALL® PRODUCTIVITY SYSTEM



Easy Order Application Kits
Includes Accessories Shown

Complete Smartwall Sink Unit

Cat. No. SWK36-1A1-SR

(1) Wall Track, (2) Uprights (1) Super Erecta Shelf, (2) Single Shelf Supports, (2) Prong Hooks, (4) Small Hooks, (1) Wire Basket, (1) Drying Shelf, (1) Utensil Holder



Packaged in One Box

SmartWall Dish Tank Unit

Cat. No. CR3COMP72

(2) Wall Tracks, (4) Uprights, (4) Single Shelf Supports, (2) Metroseal Green Super Erecta Pro Shelves, (2) Metroseal Green Wire Grids, (2) Lid Storage Racks, (6) Cylinder Holders, (2) Deep Storage Baskets, (12) Prong Hooks



Packaged in One Box

Pizza Prep SmartWall Unit

Cat. No. SWKIT-PIZZAPREP

(1) Metroseal Gray Wire Grid, (1) Wall Track, (2) Uprights, (2) Shelf Supports, (1) Metroseal Gray Super Erecta Shelf, (1) Bottle Holder, (1) 1/3 Pan Holder, (1) Spice Rack, (1) Glove Box Holder, (1) Light Duty Shelf, (4) Prong Hooks



Packaged in One Box

Complete Smartwall Prep Unit

Cat. No. CR36SWPREP

(1) Wall Track, (2) Uprights, (1) Metroseal Green Wire Grid, (2) Single Shelf Supports, (1) Metroseal Green Super Erecta Shelf, (1) Drying Shelf, (2) Storage Baskets, (1) Utensil Cylinder, (1) Cylinder Holder, (6) Prong Hooks, (2) Standard Hooks



Packaged in One Box

Complete Smartwall Prep Unit 2

Cat. No. SWK36-1A2-SR

(1) Wall Track, (2) Uprights (1) Super Erecta Shelf, (2) Single Shelf Supports, (2) Prong Hooks, (4) Small Hooks, (1) Wire Basket, (1) Shelf (1) Clear Bin (Blue Bins are Discontinued)

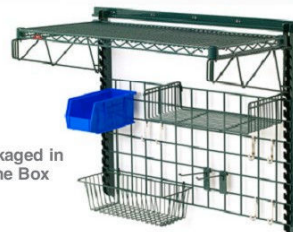

Packaged in One Box



TRY NOW >>



Easily customize & specify SmartWall in 3D.



SMART WALL ASSEMBLY

Configuring Basic Task Stations

Selecting Wall Tracks

Wall track or combination of tracks must be at least 2" (51mm) longer than the desired span of shelves. 1" (25mm) on each end of the span of tracks is reserved for hardware that acts as a stop. (Example: If 152" (3860mm) of wall track could be mounted, then the length of a shelf tier cannot exceed 150" (3810mm).

Grids

Grids may attach directly to the uprights. Grids may not overhang the uprights by more than 6" (152mm). When uprights are not used, select the appropriate grid bracket kit based on the configuration.

Uprights and Shelf Supports

Enable standard Super Erecta, Super Erecta Pro, MetroMax Q, and MetroMax i shelves to be used as part of the task station.

Combinations of Grids and Shelves

Grids can be mounted directly behind shelves, but shelf supports and grids cannot occupy the same slots on the upright. Once the grid has been mounted to the upright, the shelf support can be mounted to its own slots and can be adjusted on 3" (76mm) increments within the grid space.

Configuring Basic Wall Shelving

Selecting Wall Tracks.

Wall track or combination of tracks must be at least 2" (51mm) longer than the desired span of shelves. 1" (25mm) on each end of the span of tracks is reserved for hardware that acts as a stop. (Example: If 152" (3860mm) of wall track could be mounted, then the length of a shelf tier cannot exceed 150" (3810mm).

Uprights.

- 15" (381mm) uprights: 1 shelf tier maximum
- 30" (762mm) uprights: 3 shelf tiers maximum
- 45" (1143mm) uprights: 4 shelf tiers maximum

Shelves.

When configuring side-by-side shelving units, the adjacent shelves on the same tier must have the same depth. Minimum space between shelf tiers is 9" (229mm).

Note: When using MetroMax i shelves with SmartWall shelf supports, order one adapter kit per shelf (Cat. No. M997-4).

Shelf Supports.

Order to match up with the depth of the shelf.



SMARTWALL® PRODUCTIVITY SYSTEM

SmartWall Components — {10.42}

Wall Tracks (minimum one per system)

Joiner plates and stop fastener hardware included. Does not include hardware to mount wall tracks to the wall.



Actual Length (in.) (mm)	Actual Depth (in.) (mm)	Actual Width (in.) (mm)	Approx. Pkd. Wt. (lbs.) (kg)	Cat. No. Metroseal Gray	Cat. No. Metroseal Green
40 1016	.75 19	1.56 40	5.0 2.2	SW40K4	SW40K3
56 1423	.75 19	1.56 40	6.0 2.6	SW56K4	SW56K3
72 1829	.75 19	1.56 40	7.0 3.1	SW72K4	SW72K3

*Note: Tracks can be cut to length, but Metro does not provide this service. Touch-up paint for Metroseal Green & Gray tracks is available.

Replacement Joiner Plate Hardware

Cat. No. RPTRK-HDWE



Uprights (For medium-duty applications, minimum two per system. Sold by the piece)

Built-in slots allow shelf supports and grids to attach without tools or hardware. 1.5" (38mm) slot spacing allows shelves and grids to be adjusted on 1.5" (38mm) increments.

Cat. No. Metroseal Green	Cat. No. Metroseal Gray	Number of slots	Actual Length (in.) (mm)	Actual Width (in.) (mm)	Actual Depth (in.) (mm)
SWU15K3	SWU15K4	7	16 406	1.13 29	1.88 48
SWU30K3	SWU30K4	17	31 787	1.13 29	1.88 48
SWU45K3	SWU45K4	26	44.5 1130	1.13 29	1.88 48
-	SWU72K4	45	71.5 1829	1.13 29	1.88 48
-	SWU85K4	54	84.5 2160	1.13 29	1.88 48

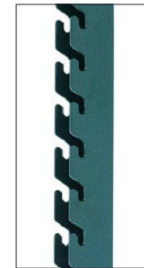

Shelf Supports (Sold by the piece)

Mount directly to slotted uprights. Suitable for use with Super Erecta, MetroMax Q, MetroMax i shelves.

Single shelf supports are used on each end of a single unit or side-by-side unit. Double (intermediate) shelf supports are used when configuring side-by-side wall shelving units.

Single Shelf Supports

Fits shelf depth	Actual Length (in.) (mm)	Actual Width (in.) (mm)	Actual Height (in.) (mm)	Approx. Pkd. Wt. (lbs.) (kg)	Cat. No. Metroseal Gray	Cat. No. Metroseal Green
14" (355mm)	16.56 421	1.5 38	8.19 208	2.5 1.1	SWS14K4	SWS14K3
18" (457mm)	20.56 522	1.5 38	8.19 208	3.0 1.3	SWS18K4	SWS18K3
21" (530mm)	23.56 598	1.5 38	8.19 208	3.5 1.5	SWS21K4	SWS21K3
24" (610mm)	26.56 675	1.5 38	8.19 208	3.5 1.5	SWS24K4	SWS24K3

*Note: Replacement plastic sleeve for shelf support. Cat. No. RP-SPSLV.

Note: When using MetroMax i shelves with shelf supports, please order 1 adapter kit per shelf. Cat. No. M9997-4

Double (Intermediate) Shelf Supports

Fits shelf depth	Actual Length (in.) (mm)	Actual Width (in.) (mm)	Actual Height (in.) (mm)	Approx. Pkd. Wt. (lbs.) (kg)	Cat. No. Metroseal Gray	Cat. No. Metroseal Green
14" (355mm)	16.56 421	1.5 38	8.19 208	2.5 1.1	SWD14K4	SWD14K3
18" (457mm)	20.56 522	1.5 38	8.19 208	3.0 1.3	SWD18K4	SWD18K3
21" (530mm)	23.56 598	1.5 38	8.19 208	3.5 1.5	SWD21K4	SWD21K3
24" (610mm)	26.56 675	1.5 38	8.19 208	3.5 1.5	SWD24K4	SWD24K3

*Note: Replacement plastic sleeve for shelf support. Cat. No. RP-SPSLV.

Note: When using MetroMax i shelves with shelf supports, please order 1 adapter kit per shelf. Cat. No. M9997-4

Single Support



Double (intermediate) Support



Grid Mounting Brackets (for standard-duty applications without uprights)

- Use to connect the grid to the wall when uprights are not used. One kit required per grid.

Description	Approx. Pkd. Wt. (lbs.) (kg)	Cat. No.
Bracket kit to connect grid to wall track; includes (2) top and (4) bottom (stainless steel)	2.0 0.9	SWGB1
Direct wall mount bracket kit; consists of (6) bottom brackets (stainless steel)	2.0 0.9	SWGB2
Direct wall mount bracket kit; consists of (6) black plastic brackets	2.0 0.9	WGBRKT



Wire Grids

- Brackets to mount the grid to the wall track or the wall are not included and can attach directly to uprights without brackets or tools.
- Grid openings measure approximately 3" x 3" (76 x 76mm)

Width x Length (in.)	Width x Length (mm)	Cat. No. Plated	Cat. No. Metroseal Green	Cat. No. Metroseal Gray
18x30	457x760	—	WG1830K3	WG1830K4
18x36	457x914	WG1836BR	WG1836K3	WG1836K4
18x48	457x1219	WG1848BR	WG1848K3	WG1848K4
18x60	457x1524	WG1860BR	WG1860K3	WG1860K4
24x36	610x914	—	WG2436K3	WG1836K4
24x48	610x1219	—	WG2448K3	WG1848K4
30x36	760x914	—	WG3036K3	WG1836K4
30x48	760x1219	—	WG3048K3	WG1848K4
33x54	838x1370	PBA-GPC	—	—

*Note: Can be retrofitted to original MetroMax and MetroMax Q shelving.

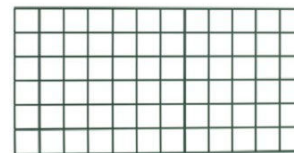

Grid: 18" x 36" (457 x 914mm)

SMARTWALL® PRODUCTIVITY SYSTEM



Tray Drying Rack
TDR48K3
For use with 1/2 size bun pans & steam pan lids, small service trays.



Pan Holder (Pan Not included)
STP3BR (Brite)
STP3K4 (Gray)



Sticker Roll/Paper Towel Holder
SRD15K3 (Green)
SRD15K4 (Gray)



Utility Shelf
SR24BR



Prong Hook
PGHK6K3 (Green)
PGHK6K4 (Gray)



Light-Duty Shelf
PBA-GSDK3 (Green)
PBA-GSDK4 (Gray)



Slanted Lid Holder / Drying Shelf
IWA-S11K3 (Green)
IWA-S11K4 (Gray)
For use with 1/2 and 1/3 size lids.



Lid Holder / Drying Shelf
IWA-11K3 (Green)
IWA-11K4 (Gray)
For use with 1/6 and 1/9 size lids.



Large Utensil Holder
IWA-12K3 (Green)
IWA-12K4 (Gray)



Double Large Hooks
HK26C



Large Hook
HK25C



Small Hook
HK23C



Small Basket
H209K3 (Green)
H209K4 (Gray)



Large 5" Deep Basket
H210K3 (Green)
H210K4 (Gray)



Shelf with Retaining Ledge: 14" (356mm) x 36" (895mm) Shown
GS11436K3 (Green)
GS11436K4 (Gray)



Grid Shelf
FGS1224K3 (Green)
FGS1224K4 (Gray)



Glove Box Holder (Vertical)
GBHVK3 (Green)
GBHVK4 (Gray)



Cylinder Holder
FCH
White Utensil Cylinder
FC1



SMARTWALL® PRODUCTIVITY SYSTEM

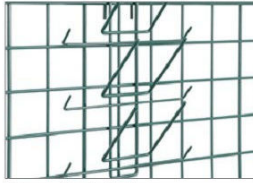

6 Prong Bottle Holder
BH6K3 (Green)
BH6K4 (Gray)



Bin Holder
 Single 3" (76mm): **DD3722A**
 Small 11" (280mm): **PBA-1BH**
 Large 22" (559mm): **PBA-2BH**



Large 10" Deep Basket
H212K3 (Green)
H212K4 (Gray)



Hanging File Holder
PBA-PFH (Chrome)

Accessories for Grids — {10.42}

Shelves	Dimensions (in)	Dimensions (mm)	Cat. No. Metroseal Green	Cat. No. Metroseal Gray
14"x36" (356 x 914mm) Shelf w/Retaining Edge	15.38 x 35.25 x 7.75	391 x 895 x 197	GS1436K3	GS1436K4
14"x48" (356 x 1219mm) Shelf w/Retaining Edge	15.38 x 47.25 x 7.75	391 x 1200 x 197	GS1448K3	GS1448K4
18"x30" (457 x 762mm) Shelf w/Retaining Edge	19.38 x 29.25 x 7.75	492 x 743 x 197	GS1830K3	GS1830K4
18"x36" (457 x 914mm) Shelf w/Retaining Edge	19.38 x 35.25 x 7.75	492 x 895 x 197	GS1836K3	GS1836K4
18"x48" (457 x 1219mm) Shelf w/Retaining Edge	19.38 x 47.25 x 7.75	492 x 1200 x 197	GS1848K3	GS1848K4
Light-Duty Shelf with Side Ledges	9 W x 18.5 L	288 W x 470 L	PBA-GSDK3	PBA-GSDK4
Flat Grid Shelf 24" (610mm)	12.69 x 24 x 4	322 x 610 x 102	FGS1224K3	FGS1224K4

Hooks	Dimensions (in)	Dimensions (mm)	Cat. No. Metroseal Green	Cat. No. Metroseal Gray	Cat. No. Chrome
Small Hook	1.25 x 3.5	32 x 89	-	-	HK23C
Large Hook	2 x 3.5	50 x 89	-	-	HK25C
Double Large Hook	2 x 3.5	50 x 89	-	-	HK26C
6" (152mm) Prong Hook	1.25 x 7.63 x 5.63	32 x 194 x 92	PGHK6K3	PGHK6K4	-

Baskets	Dimensions (in)	Dimensions (mm)	Cat. No. Metroseal Green	Cat. No. Metroseal Gray
Small Basket	13.38 x 5 x 7	345 x 127 x 180	H209K3	H209K4
5" (127mm) Deep Large Basket	17.38 x 7.5 x 5	440 x 190 x 127	H210K3	H210K4
10" (254mm) Deep Large Basket	17.38 x 7.5 x 10	440 x 190 x 255	H212K3	H212K4

Bins & Bin Holders	Dimensions (in)	Dimensions (mm)	Cat. No. Metroseal Green	Cat. No. Metroseal Gray
Clear Bin Packed 12/Ctn.	10.88 x 5.5 x 5	279 x 140 x 127	-	MB30230CLSH
Clear Bin Packed 6/Ctn.	10.88 x 11 x 5	279 x 280 x 127	-	MB30235CLSH
Clear Bin Packed 12/Ctn.	14.75 x 8 1/4 x 7	375 x 210 x 180	-	MB30240CLSH
3" (76mm) Single Bin Holder	3 x 3	76 x 76	-	DD3722A
11" (280mm) Small Bin Holder	11 x 3	280 x 76	-	PBA-1BH
22" (559mm) Large Bin Holder	22 x 3	559 x 76	-	PBA-2BH

Drying Rack Accessories	Dimensions (in)	Dimensions (mm)	Cat. No. Metroseal Green	Cat. No. Metroseal Gray
Slanted Lid Holder / Drying Shelf	14.13 x 20.75 x 12.13	359 x 527 x 307	IWA-S11K3	IWA-S11K4
Lid Holder / Drying Shelf	8.25 x 13.5 x 4.5	210 x 343 x 114	IWA-11K3	IWA-11K4
Tray Drying Rack	14.56 x 46.25 x 10.19	371 x 1175 x 259	TDR48K3	TDR48K4
6-prong Bottle Holder	14.63 x 5.13 x 11	378 x 130 x 279	BH6K3	BH6K4

Utensil Holder	Dimensions (in)	Dimensions (mm)	Cat. No. Metroseal Green	Cat. No. Metroseal Gray
Large Utensil Holder	10.5 x 10.38 x 4	267 x 264 x 102	IWA-12K3	IWA-12K4
Small Utensil Holder	4.38 x 10.38 x 4	111 x 264 x 102	IWA-14K3	IWA-14K4
White Flatware/Instrument Cylinder	4.31 x 4.31 x 5.5	109 x 109 x 140	FC1	FC1
Cylinder Holder	2.63 x 5.88 x 5.75	67 x 149 x 146	FCH	FCHK4

Miscellaneous Accessories	Dimensions (in)	Dimensions (mm)	Cat. No. Metroseal Green	Cat. No. Metroseal Gray	Cat. No. Chrome
Utility Shelf / Spice Rack	10.88 x 5.5 x 5	279 x 140 x 127	SR24K3	SR24K4	-
Insert Pan Holder	10.88 x 11 x 5	279 x 280 x 127	STP3K4	-	STP3BR
Hanging File Holder	14.75 x 8.25 x 7	375 x 210 x 180	-	-	PBA-PFH
Glove Box Holder (Vertical)	Inside Dimensions 5.88" Wx3.44" D [267mm Wx87mm D]	-	GBHVK3	GBHVK4	-
Glove Box Holder (Horizontal)	Inside Dimensions 10.125" Wx3.44" D [259mm Wx87mm D]	-	-	GBHHK4-S	-
Sticker Roll / Paper Towel Holder	Overall Dimensions (Width/Length/Height): 5" x 18.25" x 3.75" (127 x 470 x 95mm) Note: Tube dimension for holding rolls: 14.75" (375mm). Fits up to 6.25" (159mm) diameter	-	SRD15K3	SRD15K4	-

SUPER ERECTA® WALL MOUNTS



Wall Mounts

An ideal method for storing items overhead or above work surfaces.

- Brackets accommodate all Super Erecta® sizes and types of shelves.
- Use double supports to mount adjacent shelves, single supports at ends.
- Metal caps to cover openings are provided.
- Available in chrome, Metroseal Gray, Metroseal Green or stainless steel.

Post-Type Wall Mounts — {10.40}

Standard Units

Post-type wall mounts are available in pre-packaged “End Units” and “Mid Units”; complete with all needed components except shelves, wall bolts or screws, which must be selected according to type of wall.

A “End Unit” consists of two posts with wall mounting brackets, and two single shelf supports for each shelf level.

B “Mid Unit” consists of one post with brackets and double support for each shelf.

Note: If shelving is to be the length of one shelf, order End Unit only.

If two-shelf lengths, order one End Unit and one Mid Unit; three lengths, one End and two Mid Units; four lengths, one End and three Mid Units; etc.

For 14" (355mm) Shelf Width

Shelf Levels	Approx. Pkd. Wt. (lbs.)	Approx. Pkd. Wt. (kg)	Cat. No. End Unit	Approx. Pkd. Wt. (lbs.)	Approx. Pkd. Wt. (kg)	Cat. No. Mid Unit
1	7	3.2	SW21C	5	2.3	AW21C
2	14	6.4	SW23C	9	4.1	AW23C
3	22	10	SW25C	14	6.4	AW25C
4	28	12.7	SW26C	18	8.2	AW26C

For 18" (457mm) Shelf Width

Shelf Levels	Approx. Pkd. Wt. (lbs.)	Approx. Pkd. Wt. (kg)	Cat. No. End Unit	Approx. Pkd. Wt. (lbs.)	Approx. Pkd. Wt. (kg)	Cat. No. Mid Unit
1	7	3.2	SW31C	5	2.3	AW31C
2	14	6.4	SW33C	11	5	AW33C
3	22	10	SW35C	17	8	AW35C
4	28	12.7	SW36C	21	9.5	AW36C

For 21" (530mm) Shelf Width

Shelf Levels	Approx. Pkd. Wt. (lbs.)	Approx. Pkd. Wt. (kg)	Cat. No. End Unit	Approx. Pkd. Wt. (lbs.)	Approx. Pkd. Wt. (kg)	Cat. No. Mid Unit
1	8	3.6	SW41C	6	2.7	AW41C
2	16	7.3	SW43C	12	5.5	AW43C
3	25	11.3	SW45C	18	8.2	AW45C
4	32	14.4	SW46C	23	10.4	AW46C

For 24" (610mm) Shelf Width

Shelf Levels	Approx. Pkd. Wt. (lbs.)	Approx. Pkd. Wt. (kg)	Cat. No. End Unit	Approx. Pkd. Wt. (lbs.)	Approx. Pkd. Wt. (kg)	Cat. No. Mid Unit
1	9	4.1	SW51C	6	2.7	AW51C
2	18	8.2	SW53C	12	5.5	AW53C
3	28	12.7	SW55C	19	9	AW55C
4	36	16	SW56C	24	10.9	AW56C

***Note:** User should determine that wall material and method of mounting are suitable to support the shelves and their contents. Mounting hardware not included.

See page 48 for Super Erecta shelves.



Post-Type Wall Mount Installation
*Shelf supports are chrome-plated.

Post-Type Wall Mounts

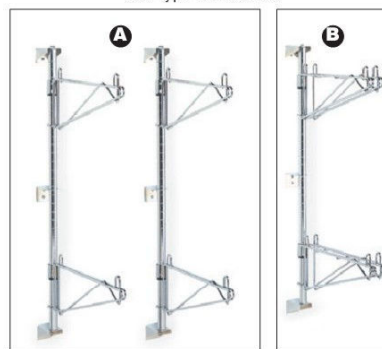

End Unit

Mid Unit

Maximum Load Rating: 250 lbs. (113kg) per shelf, not to exceed 250 lbs. (113kg) per unit.

Metro Tip:

Have you looked at your walls lately? Unused wall space provides the perfect opportunity for a significant increase in storage capacity. Metro offers a complete line of wall shelving systems to maximize storage density.



SUPER ERECTA® WALL MOUNTS

Posts and Brackets — {10.40}

Two end brackets (BES) are supplied with each of these double-footed posts. One intermediate bracket (BCS) is supplied with 33PDF posts and two are supplied with 54PDF and 63PDF posts. Order desired number/style of shelf supports below.

Post Height (in.) (mm)	Description	Approx. Pkd. Wt. (lbs.) (kg)	Cat. No. Chrome	Cat. No. Metroseal Green with Microban®	Cat. No. Metroseal Gray with Microban®	Cat. No. Stainless
13.88 350	Post for 1 tier	1.25 0.6	13PDF	13PDFK3	13PDFK4	13PDFS
33.63 854	Post for 2 tiers	2.75 1.2	33PDF	33PDFK3	33PDFK4	33PDFS
54 1370	Post for 3 or more tiers	5 2.3	54PDF	54PDFK3	54PDFK4	54PDFS
62 1573	Post for 4 or more tiers	6 2.7	63PDF	63PDFK3	63PDFK4	63PDFS
	End Bracket	.5 0.2	BES	BESK3	BESK4	SBES
	Intermediate Bracket	.5 0.2	BCS	BCSK3	BCSK4	SBCS

Note: User should determine that wall material and method of mounting are suitable to support the shelves and their contents.

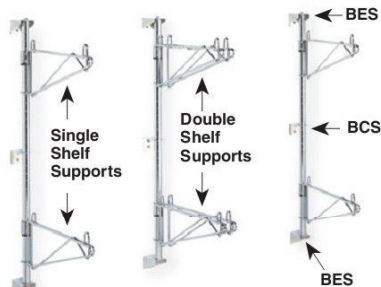

Maximum Load Rating:
250 lbs. (113kg) per shelf,
not to exceed 250 lbs.
(113kg) per unit.

See page 48 for Super Erecta shelves.

Typical configuration using two end units and one mid unit

Corner Adapters for MetroMax i shelving

Use when joining MetroMax i shelves with wire shelf supports. Box of 4. Use one box per shelf.

Cat. No. M9997-4

Corner Adapters for MetroMax 4 shelving

Use when joining MetroMax 4 shelves with wire shelf supports. Box of 4. Use one box per shelf.

Cat. No. MAX4-9997-4

Metro Tip:

MetroMax Q, MetroMax 4, and MetroMax i shelves can be used with Super Erecta Post Mounting Shelf Supports and Direct Wall Mounts.

Shelf Supports — Post Mounting — {10.40}

Single — Two required per shelf (one at each end.)

Shelf Width (in.) (mm)	Approx. Pkd. Wt. (lbs.) (kg)	Cat. No. Chrome	Cat. No. Metroseal Green with Microban®	Cat. No. Metroseal Gray with Microban®	Cat. No. Stainless
14 355	2 0.9	1WS14C	1WS14K3	1WS14K4	1WS14S
18 457	2 0.9	1WS18C	1WS18K3	1WS18K4	1WS18S
21 530	2.5 1.1	1WS21C			1WS21S
24 610	3 1.4	1WS24C	1WS24K3	1WS24K4	1WS24S

Double — For run of multiple shelves.

Shelf Width (in.) (mm)	Approx. Pkd. Wt. (lbs.) (kg)	Cat. No. Chrome	Cat. No. Metroseal Green with Microban®	Cat. No. Metroseal Gray with Microban®	Cat. No. Stainless
14 355	3 1.4	2WS14C	2WS14K3	2WS14K4	2WS14S
18 457	3.75 1.7	2WS18C	2WS18K3	2WS18K4	2WS18S
21 530	4.25 1.9	2WS21C			2WS21S
24 610	4.5 2.0	2WS24C	2WS24K3	2WS24K4	2WS24S

Order shelves from page 48.

Direct Wall Mounts — {10.40}

Each consists of one shelf support and mounting plate, with two shelf collar caps. Use single support at shelf ends; double support for adjoining shelves.

Single — Two required per shelf

Shelf Width (in.) (mm)	Approx. Pkd. Wt. (lbs.) (kg)	Cat. No. Chrome	Cat. No. Metroseal Green with Microban®	Cat. No. Metroseal Gray with Microban®	Cat. No. Stainless
14 355	1.5 0.7	1WD14C	1WD14K3	1WD14K4	1WD14S
18 457	2 0.9	1WD18C	1WD18K3	1WD18K4	1WD18S
21 530	2 0.9	1WD21C	1WD21K3	1WD21K4	1WD21S
24 610	2.25 1.0	1WD24C	1WD24K3	1WD24K4	1WD24S

Double

Shelf Width (in.) (mm)	Approx. Pkd. Wt. (lbs.) (kg)	Cat. No. Chrome	Cat. No. Metroseal Green with Microban®	Cat. No. Metroseal Gray with Microban®	Cat. No. Stainless
14 355	3 1.4	2WD14C	2WD14K3	2WD14K4	2WD14S
18 457	3 1.4	2WD18C	2WD18K3	2WD18K4	2WD18S
21 530	4 1.8	2WD21C	2WD21K3	2WD21K4	2WD21S
24 610	4.5 2.0	2WD24C	2WD24K3	2WD24K4	2WD24S

Note: User should determine that wall material and method of mounting are suitable to support the shelves and their contents.



Single Shelf Support



Double Shelf Support



Hole Plugs — {10.06}

This chrome-plated cover is used to fill shelf-corner openings. Use wherever posts have been eliminated by "S" hooks.

Cat. No. 9997C

ERECTA SHELF®/METROMAX® i WALL SHELVING



Direct Wall Mount Shelving — {10.40}

Use standard Super Erecta stainless steel direct wall mount shelf supports with MetroMax shelves or open frames with wire drop in baskets. Order one MetroMax corner adapter kit with each shelf or shelf frame. Shelf supports are sold individually.

NSF Note: Wall shelving is NSF listed.

Single — Use at shelf ends; two are required for a stand-alone shelf.

Shelf Width (in.)	Shelf Width (mm)	Approx. Pkd. Wt. (lbs.) (kg)		Cat. No. Stainless Steel
18	457	2	0.9	1WD18S
24	610	2.25	1.0	1WD24S

Double — When constructing a run of shelves, use double shelf supports to join adjacent shelves.

Shelf Width (in.)	Shelf Width (mm)	Approx. Pkd. Wt. (lbs.) (kg)		Cat. No. Stainless Steel
18	457	3	1.4	2WD18S
24	610	4.25	2.0	2WD24S



Wall Mount Brackets shown with MetroMax i Open Frame and Drop-In Basket.

For MetroMax i Open Frame and Drop-In Basket, see page 29.

Corner Adapters for MetroMax i shelving

Use when joining MetroMax i shelves with wire shelf supports. Box of 4. Use one box per shelf. **Cat. No. M9997-4**

Corner Adapters for MetroMax 4 shelving

Use when joining MetroMax 4 shelves with wire shelf supports. Box of 4. Use one box per shelf. **Cat. No. MAX4-9997-4**

Erecta Shelf® Wall Mounts — {10.56}

Used to create wall-mounted shelving units with 12" (305mm) or 18" (457mm) Erecta shelves of any length.

- Models are available to accommodate from one to five shelves. (Each mount consists of two shelf supports and mounting brackets.)
- Wall bolts or screws not included; they must be selected according to type of wall.
- Order shelves from page 77.



Wall Mounts with Shelf (Shelf sold separately, see page 77)

Width (in.)	Width (mm)	Height (in.)	Height (mm)	Capacity	Approx. Pkd. Wt. (Pcs.) (lbs.) (kg)		Cat. No. Chrome
12	305	10.75	273	1 Shelf	2.5	1.1	12WB1C
12	305	20.81	528	1 to 3 Shelves	5	2.3	12WB3C
12	305	30.81	782	1 to 5 Shelves	7.25	3.2	12WB5C
18	457	11.75	298	1 Shelf	3	1.4	18WB1C
18	457	21.63	548	1 to 3 Shelves	6	2.7	18WB3C
18	457	31.63	807	1 to 5 Shelves	8.5	3.8	18WB5C

For additional mounting brackets (single) order Cat. No. 9975C

Double mounting brackets are also available for use where continuous wall shelving is to be installed. **Cat. No. 9976C**

Load Rating: 200 lbs. (91kg) per shelf, not to exceed 200 lbs. (91kg) per unit.

Units must be secured to sufficient wall support structure.

Erecta Shelf® Wall Kit — {10.56}

Kit includes two shelves, shelf supports, and mounting brackets. Wall bolts and screws not included; they must be selected according to type of wall. Chrome.

Shelf Length (in.)	Shelf Length (mm)	Overall Length (in.)	Overall Length (mm)	Shelf Width (in.)	Shelf Width (mm)	Overall Width (in.)	Overall Width (mm)	Overall Height (in.)	Overall Height (mm)	Approx. Pkd. Wt. (lbs.) (kg)	Cat. No.	
24	610	26.25	673	12	305	13	330	21	530	18.5	8.3	12WS12C
36	914	38.25	971	12	305	13	330	21	530	25.25	11.3	12WS32C
48	1219	50.25	1283	12	305	13	330	21	530	32	14.4	12WS52C

Kit packaged in one box and UPS shippable.

Load Rating: 200 lbs. (91kg) per shelf, not to exceed 200 lbs. (91kg) per unit.

Units must be secured to sufficient wall support structure.



12WS12C Erecta Shelf® Wall Kit

Metro Design Tools

The easy way to customize & specify in 3D.



Metro has created these amazing, proprietary tools to help you build, layout, and specify select Metro products. These tools are **FREE** to use and can be accessed on metro.com.

Give it a try... they are super-simple.

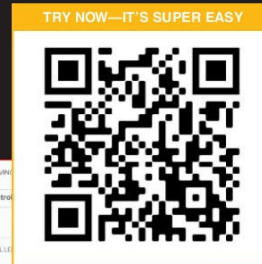
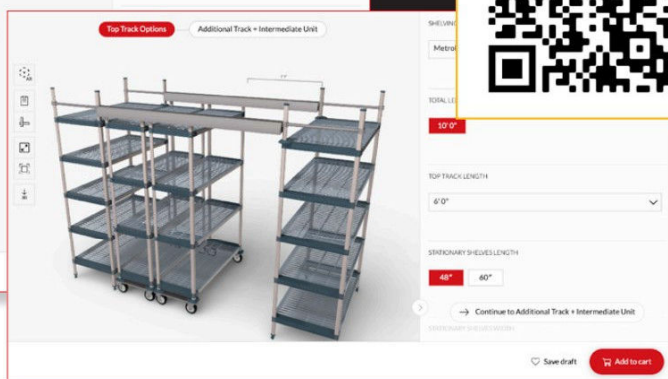
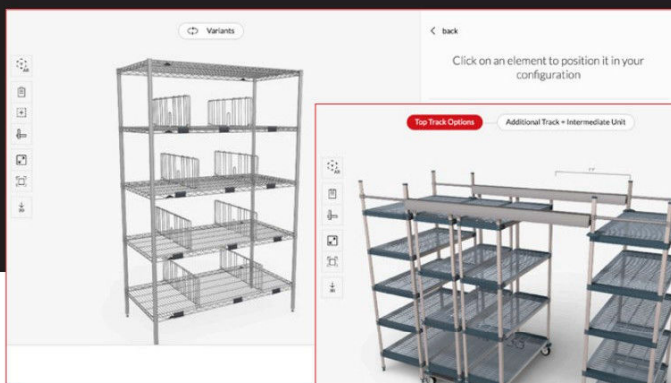

1.800.992.1776 • WWW.METRO.COM

131

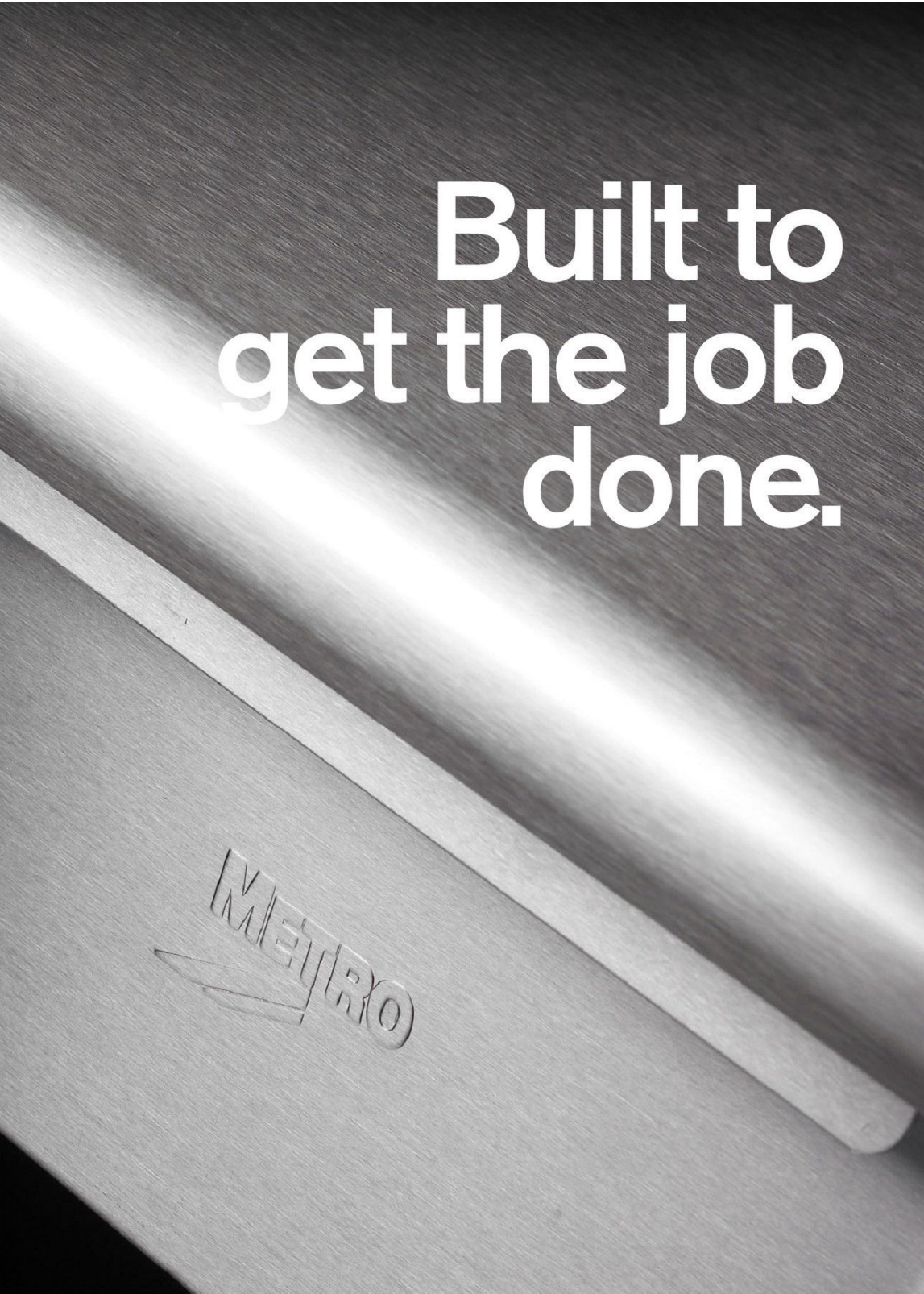

**Built to
get the job
done.**

SmartLever™
HD Super™

WORKSTATIONS & WORKTABLES

Workstations & Worktables132-147
Smartlever Workstations.....134-139
Stainless Steel Worktables & Accessories.....140-145



LEARN MORE

Nothing gets in the way of productivity.



Safely Hold up to **2800lbs.** per section.



SmartLever™ Multifunctional Storage & Workstations — {17.30}

Create the ultimate usable space by combining shelving, stainless worksurface, and SmartWall productivity system.

Specifications

- Structure: Heavy gauge cold rolled steel electroplated and epoxy coated with stainless steel hardware.
- Work Surface: 16 gauge, type 304 stainless steel top with Duraplast anti-drumming support.
- Support Arms: 11-gauge stainless steel coated with epoxy.
- Dunnage: heavy gauge steel electroplated and epoxy coated
- Work surface and shelving height adjustable on 2" increments.
- Warranty: 10 year limited warranty against surface rust formation.
- Load Capacity:
 - The total weight load capacity of each model including the bottom shelf, is 2,800 lbs. (1271kg).
 - Each level (work surface or shelf) has a maximum evenly distributed weight load capacity of 600 lbs. (272kg).
 - The maximum uniformly distributed load on the Dunnage rack must not exceed 1,000 lbs. (454kg).



Utilizes Metro Shelving

including but not limited to: Super Erecta, Super Erecta Pro, SmartWall Grid and accessories, and Flat Stainless Shelves.



SmartLever Shelving U or L Configurations



SMARTLEVER™ PRODUCTIVITY SYSTEM

Ordering your SmartLever.

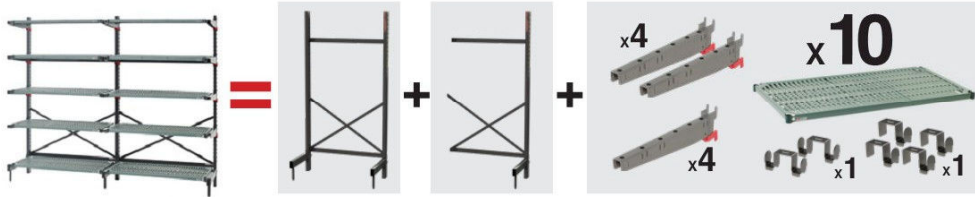

Quantity Needed	Cat. No.	Description
1	SM762448-KIT	SmartLever 21x48 Starter Unit Kit
1	SM762448-ADD	SmartLever 21x48 Add-on Unit Kit
4	SMA24A	Pair 21" SmartLever Arms

Quantity Needed	Cat. No.	Description
4	SMA24A-ADD	Single 21" SmartLever Arms
10	PR2148NK3	21x48 Super Erecta Pro Shelf
1	LSH1	Single Leg Hook (4 Pack)
1	LSH2	Double Leg Hook (2 Pack)

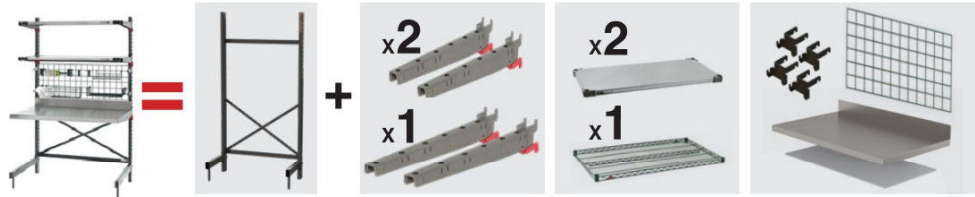

Quantity Needed	Cat. No.	Description
1	SM763042-KIT	SmartLever 30x42 Starter Unit Kit
1	SMW42	SmartLever 30x42 SS Work Surface
1	3042NK3	30x42 Epoxy Coated Wire Shelf
2	SMA18A	Pair 18" SmartLever Arms

Quantity Needed	Cat. No.	Description
1	SMA30A	Pair 30" SmartLever Arms
1	WG1842K3	18x42 SmartWall Accessory Grid
1	SMR	SmartLever Grid Bracket (4 pack)
2	1842FS	18x42 Flat Stainless Steel Shelf

Note: Grid accessories are not included and can be ordered separately



SmartLever Shelving Workstation Integration



SmartLever Continuous Shelving



SmartLever Equipment Station

1.800.992.1776 • WWW.METRO.COM

SMARTLEVER™ PRODUCTIVITY SYSTEM



SmartLever's flexibility comes from its versatility. It's a modular system of Uprights, Legs, Cross Bracing, Arm, Shelves, Work Surfaces, and Accessories that gives you the ability to optimize storage and workspace throughout your facility.

Uprights & Legs

SmartLever's strength comes from its robust Upright and Leg System. Legs bolt to the upright and can be ordered separately or as part of our convenient Starter and Add-On Kits. Uprights allow Shelves to be adjusted and positioned on 2" increments.

Part #	Description	Part #	Description
SMU76	76" SmartLever Upright	SML18	18" Nominal SmartLever Leg
SMU86	86" SmartLever Upright	SML21	21" Nominal SmartLever Leg
		SML24	24" Nominal SmartLever Leg
		SML30	30" Nominal SmartLever Leg

Cross Brace Kits

SmartLever's stability comes from its Cross Bracing System. Each Cross Brace Kit consists of two Cross Bars and a set of Cross Bracing.

Part #	Description
SMB24	24" Nominal SmartLever Cross Brace Kit w/Hardware
SMB30	30" Nominal SmartLever Cross Brace Kit w/Hardware
SMB36	36" Nominal SmartLever Cross Brace Kit w/Hardware
SMB42	42" Nominal SmartLever Cross Brace Kit w/Hardware
SMB48	48" Nominal SmartLever Cross Brace Kit w/Hardware
SMB54	54" Nominal SmartLever Cross Brace Kit w/Hardware
SMB60	60" Nominal SmartLever Cross Brace Kit w/Hardware
SMB72	72" Nominal SmartLever Cross Brace Kit w/Hardware

Arms

SmartLever's **Patent Pending** Arm Design holds heavy loads, is more durable, can hold different width shelves on the same arm, and come with arm locks installed for the ultimate in adjustability and security. Sold as pairs or individually ("-ADD" parts) SmartLever Arms also come with Shelf Mounting Hooks and Locking Wedges

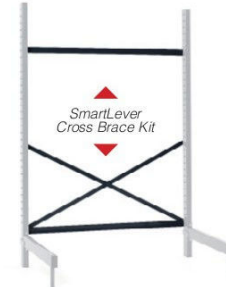
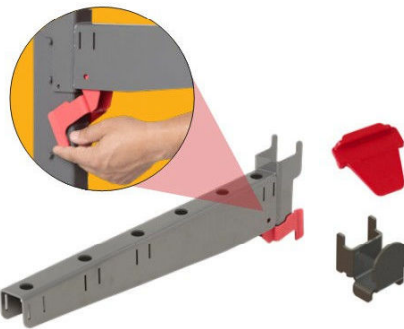

Part #	Description	# of Arms	# of Shelf Mount Hooks	# of Locking Wedges
SMA14A	Pair 14" SmartLever Arms	2	4	4
SMA14A-ADD	Single 14" SmartLever Arm	1	4	4
SMA18A	Pair 18" SmartLever Arms	2	4	4
SMA18A-ADD	Single 18" SmartLever Arm	1	4	4
SMA21A	Pair 21" SmartLever Arms	2	4	4
SMA21A-ADD	Single 21" SmartLever Arm	1	4	4
SMA24A	Pair 24" SmartLever Arms	2	4	4
SMA24A-ADD	Single 24" SmartLever Arm	1	4	4
SMA30A	Pair 30" SmartLever Arms	2	4	4
SMA30A-ADD	Single 30" SmartLever Arm	1	4	4



SMARTLEVER™ PRODUCTIVITY SYSTEM

Shelves

SmartLever's ultimate flexibility comes from the integration of standard Metro Shelving. All Super Erecta (round post) shelves work with SmartLever's shelf mounting hooks.

1. Select Super Erecta Pro shelving for all-around superior performance in all environments based on its easy-to-clean removable mat designs and inherent corrosion protection.
2. Choose Super Erecta for basic applications. Metroseal is recommended but all wire shelving finishes are compatible
3. Utilize Super Erecta Solid Shelving for hybrid work surfaces, work surface overhead shelves, or whenever spill mitigation is important. Stainless steel is recommended for use with SmartLever but all solid shelving styles are compatible
4. Super Erecta Dunnage hold heavy loads supported on SmartLever's Legs with the use of Single or Double Leg Hooks (also for use with other style shelves mounted on the Legs of the unit). Dunnage shelves hold 1,000 lbs. when mounted to Legs using Leg Hook (must order separately – see below) and 600 lbs. when mounted to Arms.

Shelving Size L x W (in.)	Super Erecta Pro	Super Erecta Solid Stainless	Super Erecta Metroseal Green	Super Erecta Metroseal Gray	Super Erecta Brite	Super Erecta Chrome	Super Erecta Stainless	Super Erecta Metroseal Green
14 24	PR1424NK3	1424FS	1424NK3	1424NK4	1424BR	1424NC	1424NS	-
14 30	PR1430NK3	1430FS	1430NK3	1430NK4	1430BR	1430NC	1430NS	-
14 36	PR1436NK3	1436FS	1436NK3	1436NK4	1436BR	1436NC	1436NS	-
14 42	PR1442NK3	1442FS	1442NK3	1442NK4	1442BR	1442NC	1442NS	-
14 48	PR1448NK3	1448FS	1448NK3	1448NK4	1448BR	1448NC	1448NS	-
14 54	-	-	-	-	-	-	-	-
14 60	PR1460NK3	1460FS	1460NK3	1460NK4	1460BR	1460NC	1460NS	-
14 72	PR1472NK3	-	1472NK3	1472NK4	1472BR	1472NC	1472NS	-
18 2	PR1824NK3	1824FS	1824NK3	1824NK4	1824BR	1824NC	1824NS	1824DRK3
18 30	PR1830NK3	1830FS	1830NK3	1830NK4	1830BR	1830NC	1830NS	1830DRK3
18 36	PR1836NK3	1836FS	1836NK3	1836NK4	1836BR	1836NC	1836NS	1836DRK3
18 42	PR1842NK3	1842FS	1842NK3	1842NK4	1842BR	1842NC	1842NS	1842DRK3
18 48	PR1848NK3	1848FS	1848NK3	1848NK4	1848BR	1848NC	1848NS	1848DRK3
18 54	PR1854NK3	-	1854NK3	1854NK4	1854BR	1854NC	1854NS	1854DRK3
18 60	PR1860NK3	1860FS	1860NK3	1860NK4	1860BR	1860NC	1860NS	1860DRK3
18 72	PR1872NK3	1872FS	1872NK3	1872NK4	1872BR	1872NC	1872NS	-
21 24	PR2124NK3	2124FS	2124NK3	2124NK4	2124BR	2124NC	2124NS	2124DRK3
21 30	PR2130NK3	2130FS	2130NK3	2130NK4	2130BR	2130NC	2130NS	2130DRK3
21 36	PR2136NK3	2136FS	2136NK3	2136NK4	2136BR	2136NC	2136NS	2136DRK3
21 42	PR2142NK3	2142FS	2142NK3	2142NK4	2142BR	2142NC	2142NS	2142DRK3
21 48	PR2148NK3	2148FS	2148NK3	2148NK4	2148BR	2148NC	2148NS	2148DRK3
21 54	PR2154NK3	-	2154NK3	2154NK4	2154BR	2154NC	2154NS	2154DRK3
21 60	PR2160NK3	2160FS	2160NK3	2160NK4	2160BR	2160NC	2160NS	2160DRK3
21 72	PR2172NK3	-	2172NK3	2172NK4	2172BR	2172NC	2172NS	-
24 24	PR2424NK3	2424FS	2424NK3	2424NK4	2424BR	2424NC	2424NS	2424DRK3
24 30	PR2430NK3	2430FS	2430NK3	2430NK4	2430BR	2430NC	2430NS	2430DRK3
24 36	PR2436NK3	2436FS	2436NK3	2436NK4	2436BR	2436NC	2436NS	2436DRK3
24 42	PR2442NK3	2442FS	2442NK3	2442NK4	2442BR	2442NC	2442NS	2442DRK3
24 48	PR2448NK3	2448FS	2448NK3	2448NK4	2448BR	2448NC	2448NS	2448DRK3
24 54	PR2454NK3	-	2454NK3	2454NK4	2454BR	2454NC	2454NS	2454DRK3
24 60	PR2460NK3	2460FS	2460NK3	2460NK4	2460BR	2460NC	2460NS	2460DRK3
24 72	PR2472NK3	2472FS	2472NK3	2472NK4	2472BR	2472NC	2472NS	-
30 36	-	-	3036NK3	3036NK4	-	3036NC	3036NS	-
30 42	-	-	3042NK3	3042NK4	-	3042NC	-	-
30 48	-	-	3048NK3	3048NK4	-	3048NC	3048NS	-
30 54	-	-	3054NK3	3054NK4	-	3054NC	-	-
30 60	-	-	3060NK3	3060NK4	-	3060NC	3060NS	-
30 72	-	-	3072NK3	3072NK4	-	3072NC	3072NS	-

*Arm size must match shelf depth. For example, 2148NK3 shelf will use SMA 21A.



Super Erecta Pro



Super Erecta Solid Stainless Steel



Super Erecta MetroSeal

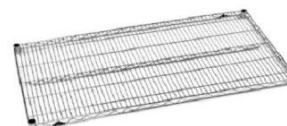

Super Erecta Stainless Steel, Brite or Chrome Finish



Super Erecta MetroSeal Dunnage

Leg Hooks

Leg hooks are used to install any shelf on the legs as the bottom shelf of the unit.



Cat. No.	Description
LSH1	Single Leg Hook (4 Pack)
LSH2	Double Leg Hook (2 Pack)

SMARTLEVER™ PRODUCTIVITY SYSTEM



Work Surfaces

Create a versatile and productive workstation with SmartLever Work Surfaces. Work Surfaces are 16 gauge Type 304 Stainless Steel with a 4" seamless back splash and mount over 30" Shelves (30" Arms and 30" deep Shelves must be ordered separately with the work surface). Work surface heights can be set at any height in 2" increments for optimal ergonomics and work flow. Work surfaces include a sound deadening inlay and support 600 lbs evenly distributed.

Cat. No.	Description	Approx. Pkd. Wt. (lbs.)	Approx. Pkd. Wt. (kg)	Width (in)	Length (in)
SMW36	SmartLever 30x36 SS Work Surface	33.6	15.3	30.25	39.75
SMW42	SmartLever 30x42 SS Work Surface	38.3	17.5	30.25	45.75
SMW48	SmartLever 30x48 SS Work Surface	42.9	19.5	30.25	51.75
SMW54	SmartLever 30x54 SS Work Surface	47.6	21.3	30.25	57.75
SMW60	SmartLever 30x60 SS Work Surface	52.2	23.8	30.25	63.75
SMW72	SmartLever 30x72 SS Work Surface	61.4	28	30.25	75.75

*Work surfaces need a 30" deep shelf and a pair of 30" arms, which must be ordered separately.



SmartWall Grids & Brackets

SmartWall Grids can be added to SmartLever Work Stations to accommodate SmartWall Accessories (See SmartWall Accessories Spec Sheet 10.43) for the ultimate in customized productivity!

Accessory Grids

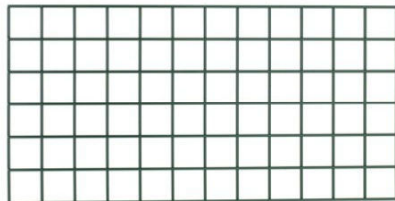

Grid Size (in)	Metroseal Green Part #	
Width	Length	
18	24	WG1824K3
18	30	WG1830K3
18	36	WG1836K3
18	42	WG1842K3
18	48	WG1848K3
18	54	WG1854K3
18	60	WG1860K3
18	72	WG1872K3
24	36	WG2436K3
24	48	WG2448K3
30	36	WG3036K3
30	48	WG3048K3



* Shown with SmartWall Accessories (Not included within specifications)

Grid Bracket

Cat. No.	Description
SMR*	SmartLever Grid Bracket (4 pack)

*must be purchased if ordering a grid.

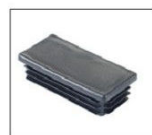

Replacement Endcap
Bag of 2
Cat. No. RPC06-1211

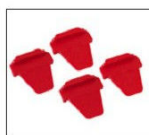

Replacement Locking Wedge
Bag of 4
Cat. No. RPSMLW



Replacement Hole Plugs
Bag of 10
Cat. No. RPSMHP



Replacement Shelf Mount Hook
Bag of 4
Cat. No. SMS

Replacement Hardware Bag Cross Bar & Cross Brace
Cat. No. RPHDWE-SMB

Replacement Bag for Arms
Cat. No. RPARM-HDWEBAG



SMARTLEVER™ PRODUCTIVITY SYSTEM

Starter & Add-on Kits

Starter kits include: two uprights, two legs, two cross bars, and cross bracing

Add-On kits include: one upright, one leg, two cross bars, and cross bracing

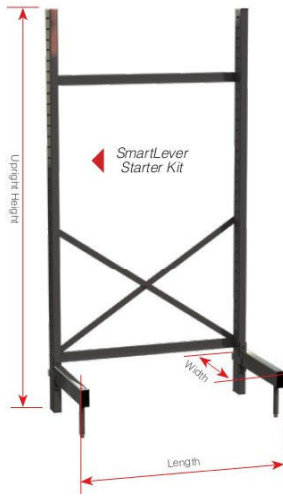

Table listing product models (e.g., SM761824-KIT), dimensions (Assembled Unit H x W x L, Shelving Size L x W), and corresponding Add-On Kit models (e.g., SM761824-ADD).

1.800.992.1776 • WWW.METRO.COM

STAINLESS STEEL WORKTABLES



Worktables.



What Type of Stainless Steel Do I Need?

The difference between 304 and 316 stainless steel is the chemical composition, with 316 containing a significant amount of molybdenum. The higher molybdenum content results in increased corrosion resistance. 316 stainless steel work surfaces are ideal for pharmaceutical manufacturing, medical, biomedical, life sciences and sterile applications where there is repeated use of harsh cleaning solutions or chloride solutions.



HD Super Heavy-Duty Worktables — {17.20}

- Seamless Type 304 or 316 stainless steel work surface and support structure with 1 5/8" posts.
- Shipped knocked down and can be assembled in minutes without tools.
- All HD Super worktables are 34" (864mm) high with stationary posts and leveling feet.
- All Mobile Worktables have special posts and four 5" (127mm) poly casters — 2 swivel/2 brake.



HD Super Heavy-Duty Worktables with Solid Bottom Shelf



Available in Stationary or Mobile

Length (in.) (mm)	Width (in.) (mm)	Description	304	304	316	316
			Stainless Steel Stationary Cat No.	Stainless Steel Mobile Cat No.	Stainless Steel Stationary Cat No.	Stainless Steel Mobile Cat No.
48 1219	30 760	Worktable w/ Solid Shelf	WT305FS	MWT305FS	WT305FS-316	MWT305FS-316
60 1524	30 760	Worktable w/ Solid Shelf	WT306FS	MWT306FS	WT306FS-316	MWT306FS-316
72 1825	30 760	Worktable w/ Solid Shelf	WT307FS	MWT307FS	WT307FS-316	MWT307FS-316
96 2439	30 760	Worktable w/ Solid Shelf	WT309FS	MWT309FS	WT309FS-316	MWT309FS-316
60 1524	36 914	Worktable w/ Solid Shelf	WT366FS	MWT366FS	-	-
72 1825	36 914	Worktable w/ Solid Shelf	WT367FS	MWT367FS	-	-
96 2439	36 914	Worktable w/ Solid Shelf	WT369FS	MWT369FS	-	-
60 1524	44 1118	Worktable w/ Solid Shelf	WT446FS	MWT446FS	-	-
72 1825	44 1118	Worktable w/ Solid Shelf	WT447FS	MWT447FS	-	-
96 2439	44 1118	Worktable w/ Solid Shelf	WT449FS	MWT449FS	-	-

All 316 stainless steel top models use 316 stainless steel lower shelf and support components.

HD Super Heavy-Duty Worktables with 3-Sided Frame



Available in Stationary or Mobile

Length (in.) (mm)	Width (in.) (mm)	Description	304	304	316	316
			Stainless Steel Stationary Cat No.	Stainless Steel Mobile Cat No.	Stainless Steel Stationary Cat No.	Stainless Steel Mobile Cat No.
48 1219	30 760	Worktable w/ 3-Sided Frame	WT305US	MWT305US	WT305US-316	MWT305US-316
60 1524	30 760	Worktable w/ 3-Sided Frame	WT306US	MWT306US	WT306US-316	MWT306US-316
72 1825	30 760	Worktable w/ 3-Sided Frame	WT307US	MWT307US	WT307US-316	MWT307US-316
96 2439	30 760	Worktable w/ 3-Sided Frame	WT309US	MWT309US	WT309US-316	MWT309US-316
60 1524	36 914	Worktable w/ 3-Sided Frame	WT366US	MWT366US	-	-
72 1825	36 914	Worktable w/ 3-Sided Frame	WT367US	MWT367US	-	-
96 2439	36 914	Worktable w/ 3-Sided Frame	WT369US	MWT369US	-	-
60 1524	44 1118	Worktable w/ 3-Sided Frame	WT446US	MWT446US	-	-
72 1825	44 1118	Worktable w/ 3-Sided Frame	WT447US	MWT447US	-	-
96 2439	44 1118	Worktable w/ 3-Sided Frame	WT449US	MWT449US	-	-

All 316 stainless steel top models use 316 stainless steel lower frame and support components.



STAINLESS STEEL WORKTABLES

HD Super Heavy-Duty Worktables with H-Frame

Length (in.) (mm)	Width (in.) (mm)	Description	304	304	316	316	
			Stainless Steel Stationary Cat No.	Stainless Steel Mobile Cat No.	Stainless Steel Stationary Cat No.	Stainless Steel Mobile Cat No.	
48	1219	30 760	Worktable w/ H-Frame	WT305HS	MWT305HS	WT305HS-316	MWT305HS-316
60	1524	30 760	Worktable w/ H-Frame	WT306HS	MWT306HS	WT306HS-316	MWT306HS-316
72	1825	30 760	Worktable w/ H-Frame	WT307HS	MWT307HS	WT307HS-316	MWT307HS-316
96	2439	30 760	Worktable w/ H-Frame	WT309HS	MWT309HS	WT309HS-316	MWT309HS-316
60	1524	36 914	Worktable w/ H-Frame	WT366HS	MWT366HS	WT366HS-316	MWT366HS-316
72	1825	36 914	Worktable w/ H-Frame	WT367HS	MWT367HS	WT367HS-316	MWT367HS-316
96	2439	36 914	Worktable w/ H-Frame	WT369HS	MWT369HS	WT369HS-316	MWT367HS-316
60	1524	44 1118	Worktable w/ H-Frame	WT446HS	MWT446HS	WT446HS-316	MWT446HS-316
72	1825	44 1118	Worktable w/ H-Frame	WT447HS	MWT447HS	WT447HS-316	MWT447HS-316
96	2439	44 1118	Worktable w/ H-Frame	WT449HS	MWT449HS	WT449HS-316	MWT449HS-316

All 316 stainless steel top models use 316 stainless steel lower shelf and support components.



Available in Stationary or Mobile

HD Super Heavy-Duty Worktables with Uprights — {17.26}

All Worktables with Overhead are 30" (760mm) wide and have rear posts that are approximately 88" (2235mm) high. Cantilever shelves for overhead models are sold separately.

Length (in.) (mm)	Width (in.) (mm)	Description	304	
			Stainless Steel Cat No.	
60	1524	30 760	Worktable w/ Solid Shelf	WTC306FS
72	1825	30 760	Worktable w/ Solid Shelf	WTC307FS
96	2439	30 760	Worktable w/ Solid Shelf	WTC309FS
60	1524	30 760	Worktable w/ 3-Sided Frame	WTC306US
72	1825	30 760	Worktable w/ 3-Sided Frame	WTC307US
96	2439	30 760	Worktable w/ 3-Sided Frame	WTC309US

All 316 stainless steel top models use 316 stainless steel lower shelf and support components. 60" model uses 54" cantilevered shelves; all larger models use 60" cantilevered shelves.

Tables **DO NOT** include cantilevered upper shelves. Order separately below.



HD Super Cantilever Shelf — {10.67}

Width/Length (in.) (mm)	Approx. Pkd. Wt.		Cat. No. Stainless
	(lbs.)	(kg)	
12x54 304x1372	11.8	5.3	1254CHS
12x60 304x1524	12.7	5.7	1260CHS



Standard-Duty Worktables — {17.40}

Space Saver Design 24" Wide (610mm)

Sturdy construction provides a robust 800 lb. load rating. Mobile tables are rated to 600 lbs. Type 304 Stainless Steel components. 1" (25mm) diameter posts and patented Super Erecta Shelf construction. Heavy-duty 14-gauge stainless steel virtually eliminates "drumming."

Preconfigured units are offered both in stationary with a leveling foot and mobile utilizing a 5" polymer corrosion resistant caster. Worktables can also be customized using Super Erecta® components in any finish to fit your application.



Available in Stationary or Mobile

Length (in.) (mm)	Width		Height		Description	304	304
	(in.) (mm)	(in.) (mm)	(in.) (mm)	(in.) (mm)		Stainless Steel Stationary Cat No.	Stainless Steel Mobile Cat No.
36	914	24 610	34 910	34 910	Worktable w/ Solid Shelf	WTC2436FS	MWTC2436FS
48	1219	24 610	34 910	34 910	Worktable w/ Solid Shelf	WTC2448FS	MWTC2448FS
60	1524	24 610	34 910	34 910	Worktable w/ Solid Shelf	WTC2460FS	MWTC2460FS
36	914	24 610	34 910	34 910	Worktable w/ 3-Sided Frame	WTC2436US	MWTC2436US
48	1219	24 610	34 910	34 910	Worktable w/ 3-Sided Frame	WTC2448US	MWTC2448US
60	1524	24 610	34 910	34 910	Worktable w/ 3-Sided Frame	WTC2460US	MWTC2460US

All Models use 316 stainless steel lower shelf and support components.

STAINLESS STEEL WORKTABLES



Stainless Steel & Resin Top Worktables



Countertop Materials

Stainless Steel: Worksurfaces are fabricated from Type 304 stainless steel which provides excellent protection in corrosive environments.

Phenolic resin: Compression molded of organic fiber-reinforced phenolic core with an integrally cured thermoset resin surface.

What material do I need?

Characteristics	Phenolic Resin	Stainless Steel
Heat Resistance	Fair*	Excellent
Abrasion Resistance	Excellent	Good
Impact Resistance	Excellent	Good
Strength	Excellent	Good
Stain Resistance	Good	Good

* Discolors with High Heat.

Choose the right casters for your application to make it mobile.

Mobile-Ready Worktables DO NOT include casters.
Casters must be ordered separately.



Recommended Casters For Stainless Steel Mobile Worktables (Four brake casters are recommended for maximum table stability)

Caster Selection Guide

Caster Series	Wheel Material	Rollability	Floor Protection	Noise	Load Rating (lbs./kg)		Corrosion Resistance	Cart Washable	Antimicrobial Additive in Wheel
5MDA/5MDBA (brake)	High Modulus Rubber	Good	Good	Low	250	114	Low	No	No
5MP/5MPB (brake)	Polyurethane	Good	Good	Moderate	300	137	Low	No	No
5PC/5PCB (brake)	Polyurethane	Good	Good	Moderate	300	137	Medium	No	No
5PCM/5PCBM (brake)	Polyurethane	Good	Good	Moderate	300	137	Medium	No	Yes
5MPGSA/5MPBGS (brake)	Polyurethane	Good	Good	Moderate	300	137	High	Yes	No

NOTE: The total weight of the equipment and its load should not exceed three times the load rating per caster. Additional stem casters, in various sizes and wheel materials, are available.



STAINLESS STEEL WORKTABLES

Stainless Steel & Phenolic Resin Top Worktables — {52.03}

- Corrosion-proof stainless steel construction throughout.
- Easy to clean smooth surfaces. Mobile units can be easily moved for cleaning.
- Available top materials include Type 304 stainless and TRESPA Phenolic resin (black or gray).
- Casters and accessories are available, but must be ordered separately.
- All tops are 30" (755mm) Wide.



Island-Top

Stainless Steel Worktables

Length (in.) (mm)	Width (in.) (mm)	Description	Stationary	Mobile-Ready
			Cat No.	Cat No.
30	755	30 755 Worktable w/ Solid Shelf	LTS30IS	LTSM30IS
36	914	30 755 Worktable w/ Solid Shelf	LTS36IS	LTSM36IS
48	1219	30 755 Worktable w/ Solid Shelf	LTS48IS	LTSM48IS
60	1524	30 755 Worktable w/ Solid Shelf	LTS60IS	LTSM60IS
30	755	30 755 Worktable w/ 3-Sided Frame	LTS30UIS	LTSM30UIS
36	914	30 755 Worktable w/ 3-Sided Frame	LTS36UIS	LTSM36UIS
48	1219	30 755 Worktable w/ 3-Sided Frame	LTS48UIS	LTSM48UIS
60	1524	30 755 Worktable w/ 3-Sided Frame	LTS60UIS	LTSM60UIS



Mobile-Ready Worktables DO NOT include casters.
Casters must be ordered separately.

LTSM30IS with casters (ordered separately)

Backsplash

Stainless Steel Worktables

Length (in.) (mm)	Width (in.) (mm)	Description	Stationary	Mobile-Ready
			Cat No.	Cat No.
30	755	30 755 Worktable w/ Solid Shelf	LTS30IS	LTSM30IS
36	914	30 755 Worktable w/ Solid Shelf	LTS36IS	LTSM36IS
48	1219	30 755 Worktable w/ Solid Shelf	LTS48IS	LTSM48IS
60	1524	30 755 Worktable w/ Solid Shelf	LTS60IS	LTSM60IS
30	755	30 755 Worktable w/ 3-Sided Frame	LTS30UIS	LTSM30UIS
36	914	30 755 Worktable w/ 3-Sided Frame	LTS36UIS	LTSM36UIS
48	1219	30 755 Worktable w/ 3-Sided Frame	LTS48UIS	LTSM48UIS
60	1524	30 755 Worktable w/ 3-Sided Frame	LTS60UIS	LTSM60UIS



Mobile-Ready Worktables DO NOT include casters.
Casters must be ordered separately.

LTS30UIS with optional accessory wire shelf

Black

Phenolic Top Worktables

Length (in.) (mm)	Width (in.) (mm)	Description	Stationary	Mobile-Ready
			Cat No.	Cat No.
30	755	30 755 Worktable w/ Solid Shelf	LTS30PB	LTSM30PB
36	914	30 755 Worktable w/ Solid Shelf	LTS36PB	LTSM36PB
48	1219	30 755 Worktable w/ Solid Shelf	LTS48PB	LTSM48PB
60	1524	30 755 Worktable w/ Solid Shelf	LTS60PB	LTSM60PB
30	755	30 755 Worktable w/ 3-Sided Frame	LTS30UPB	LTSM30UPB
36	914	30 755 Worktable w/ 3-Sided Frame	LTS36UPB	LTSM36UPB
48	1219	30 755 Worktable w/ 3-Sided Frame	LTS48UPB	LTSM48UPB
60	1524	30 755 Worktable w/ 3-Sided Frame	LTS60UPB	LTSM60UPB



Mobile-Ready Worktables DO NOT include casters.
Casters must be ordered separately.

LTSM30PB with casters (ordered separately)

Gray

Phenolic Top Worktables

Length (in.) (mm)	Width (in.) (mm)	Description	Stationary	Mobile-Ready
			Cat No.	Cat No.
30	755	30 755 Worktable w/ Solid Shelf	LTS30PG	LTSM30PG
36	914	30 755 Worktable w/ Solid Shelf	LTS36PG	LTSM36PG
48	1219	30 755 Worktable w/ Solid Shelf	LTS48PG	LTSM48PG
60	1524	30 755 Worktable w/ Solid Shelf	LTS60PG	LTSM60PG
30	755	30 755 Worktable w/ 3-Sided Frame	LTS30UPG	LTSM30UPG
36	914	30 755 Worktable w/ 3-Sided Frame	LTS36UPG	LTSM36UPG
48	1219	30 755 Worktable w/ 3-Sided Frame	LTS48UPG	LTSM48UPG
60	1524	30 755 Worktable w/ 3-Sided Frame	LTS60UPG	LTSM60UPG



Worktables DO NOT include casters.
Casters must be ordered separately.

LTSM30PG0 with casters (ordered separately)

Leveling feet on stationary units have 1.250 (31mm) vertical adjustment.
*Casters ordered separately. Refer to Caster Selection Guide for more information.
Stainless Tables are load rated at 50 lbs. per sq. foot (.024kg per sq. cm) up to a maximum of 600 lbs. (273kg) assuming evenly distributed load and caster specification meets requirement.
Note: Mobile posts include an adaptor insert that will accept Metro 5" (127mm) stem casters.

STAINLESS STEEL WORKTABLE ACCESSORIES



Stainless Steel & Resin Top Worktable Accessories

Stainless Worktable Accessories — {52.03}

Backsplash

4" (102mm) high. Attaches to phenolic table top using pre-drilled holes. Match length and color with selected countertop.

Length (in.)	(mm)	Approx. Pkd. Wt.		Cat. No. Black	Cat. No. Gray
		(lbs.)	(kg)		
27 ³ / ₄	705	5.5	2.5	LT30BSB	LT30BSG
33 ³ / ₄	875	6.5	2.9	LT36BSB	LT36BSG
45 ³ / ₄	1162	7.5	3.4	LT48BSB	LT48BSG
57 ³ / ₄	1466	9.5	4.3	LT60BSB	LT60BSG

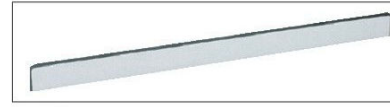

LT30BSG

Wire Shelf

Stainless shelves available.

Length (in.)	(mm)	Approx. Pkd. Wt.		Cat. No. Stainless
		(lbs.)	(kg)	
22 ⁷ / ₈	568	6	2.7	LT30WS
28 ⁷ / ₈	720	7.5	3.4	LT36WS
40 ⁷ / ₈	1025	10	4.5	LT48WS
52 ⁷ / ₈	1330	12	5.4	LT60WS



LT30WS

Note: Shelves are load rated for a maximum of 150 lbs. (68kg).



Stainless Keyboard Tray

Fits 48" and 60" (1219 and 1524mm) table lengths. Stainless keyboard tray and stainless drawer will both fit 60" (1524mm) long table.

Cat. No. LTSKB



Stainless Drawer for Phenolic Resin tops

Fits 30", 36", 48" and 60" (760, 914, 1219 and 1524mm) table lengths. Drawer, when fully extended, provides a 7.625" (194mm) opening. Stainless keyboard tray and stainless drawer will both fit 60" (1524mm) long table.

Cat. No. LTSD6



Surface Mount Swing Arm for Flat Monitor

Cat. No. LTFMA

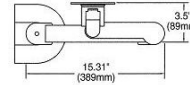
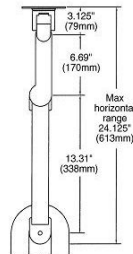
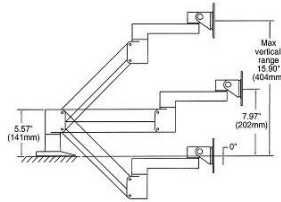



STAINLESS STEEL WORKTABLE ACCESSORIES

HD Super Heavy-Duty Worktable Accessories



Utility Rack



Utility Hook



Deluxe Drawer

HD Super™ Accessories for Worktables with Overhead — {17.26}

Utility Racks for Overhead Models

Inside dimensions measure 1.94' (48mm) high and 4.36' (109mm) wide.

Inside Length (in.)	Inside Length (mm)	Fits Units (in.)	Finish	Approx. Pkd. Wt. (lbs.) (kg)		Cat. No.
51.56	1406	60 long	Chrome-Plated	7.7	3.5	654SRC
57.56	1406	72 long & 96 long	Chrome-Plated	8.3	3.8	660SRC

Utility Hook for Cantilever Shelves

Width/Height/Depth (in.)	Width/Height/Depth (mm)	Finish	Approx. Pkd. Wt. (lbs.) (kg)		Cat. No.
.36x3.44x1.7	9x87x43	Chrome	0.1	.045	HK23C
.36x3.44x1.7	9x87x43	Stainless	0.1	.045	HK23S

Accessories for All Worktables

Economy Drawer

Overall Dimensions Width/Length/Height (in.) (mm)		Dimensions Inside Bottom (in.) (mm)		Approx. Pkd. Wt. (lbs.) (kg)		Cat. No.
14.25	28x5.75	362x	711x146	10x16	254x406	6.8 3.1 WTD21C

Deluxe Drawer

Table accepts up to two drawers stacked.

Overall Dimensions Width/Length/Height (in.) (mm)		Dimensions Inside Bottom (in.) (mm)		Approx. Pkd. Wt. (lbs.) (kg)		Cat. No.
24x25.75	x7.5	610x	654x191	20x20	508x508	31 13.9 WTD51S

HD Super Replacement Parts

HD Super™ Replacement Parts



Foot Plates 3.5" (89mm)
Cat. No. 9993HS



HD Super Plastic Split Sleeves
4 pair per bag
Cat. No. 9985H



Donut Bumpers 5.5" (140mm)
Fit 1.625" (41mm) posts only.
Cat. No. 9992H



HD Super Aluminum Split Sleeves with Zinc Ring
4 pair per bag
Cat. No. 9986HZ

Wall Mounting Brackets (not shown)
Cat. No. 9984HZ



myCart®
Deep Ledge

UTILITY CARTS & DUNNAGE

Utility Carts, Dunnage.....	146-157
Polymer Utility Carts.....	148-151
Wire & Solid Utility Carts.....	152-153
Dunnage Racks & Shelves.....	154-155

UTILITY CARTS



It's myCart, get your own.



PROTECTION THAT LIVES ON
MICROBAN



Better Containment!

Ship's edge retains small spills and prevents items from sliding off during transport.



Make it yours.

Easy & Useful

Easy-grip handle and roomy utility tray



myCart

Utility Cart

Easy to clean surface



Corrosion proof & impact resistant polymer shelves.

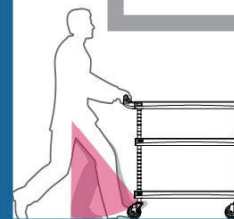

50% more legroom

You won't hit your shins or kick the cart!

Cleanable

- NSF Listed.
- Smooth surfaces easily wipe clean and won't stain.
- Specific models available with Microban® Antimicrobial product protection.

Durable

- Corrosion proof, impact resistant shelves are designed to withstand daily abuse.
- Sturdy construction: 300 lb. (136kg), 400 lb. (181kg), and 500 lb. (227kg) capacity models available.

User Friendly

- Additional legroom puts more distance between the shelves and you. You can push the cart more freely without hitting your shins and feet off the cart.
- Right-sized for common containers and racks.
- Large covered utility tray organizes small items and easily wipes clean.
- Easy-grip handle and four swivel casters ensure easy maneuvering.
- Each cart comes with two personalization labels for easy



UTILITY CARTS

myCart Series® — {12.29}

- Available in 2-shelf and 3-shelf configurations.
- .44" (11mm) deep ship's edge lip around shelf perimeter.
- MY1627 and MY2030 Base Model specs: Chrome posts, 4" (102mm) non-marking swivel casters. 150 lbs. (68kg) capacity per shelf.
- MY2636 Base Model specs: Chrome posts, 5" (127mm) swivel resilient rubber casters, 200 lbs. (90kg) capacity per shelf.



Blue **MICROBAN**
with Microban antimicrobial product protection

Purple

Gray

Black

Carts

Width/Length/Height (in.)	Width/Length/Height (mm)	Description	Load Rating Per Cart (lbs.) (kg)	Approx. Pkd. Wt. (lbs.) (kg)	Cat. No. Gray	Cat. No. Black	Cat. No. Blue with Antimicrobial	Cat. No. Purple
18.312x31.5x35.5	465x800x902	2-shelf base model	300 136	28.5 12.9	MY1627-24G	MY1627-24BL	MY1627-24BU	—
18.312x31.5x35.5	465x800x902	3-shelf base model	400 181	34 15.4	MY1627-34G	MY1627-34BL	MY1627-34BU	—
23.88x34.38x35.5	595x873x902	2-shelf base model	300 136	33 15	MY2030-24G	MY2030-24BL	MY2030-24BU	MY2030-24AP
23.88x34.38x35.5	595x873x902	3-shelf base model	400 181	41.5 19	MY2030-34G	MY2030-34BL	MY2030-34BU	MY2030-34AP
27.69x40.25x36.88	703x1022x937	2-shelf base model	400 181	40 18.1	MY2636-25G	MY2636-25BL	MY2636-25BU	—
27.69x40.25x36.88	703x1022x937	3-shelf base model	500 227	51 23.1	MY2636-35G	MY2636-35BL	MY2636-35BU	—

Accessories

- Utility bin and wastebasket can be easily removed from their holders to empty contents or for routine cleaning.

Width/Height/Depth (in.)	Width/Height/Depth (mm)	Description	Fits Cart	Load Rating (lbs.) (kg)	Approx. Pkd. Wt (lbs.) (kg)	Cat. No.
17.88x16.25x14.75	454x413x375	Wastebasket + Holder	MY1627	25 11.3	5.7 2.5	MYWB1
23x16.25x14.75	584x413x375	Wastebasket + Holder	MY2030	25 11.3	5.8 2.6	MYWB2
14.38x15.38x10.38	365x391x264	Wastebasket Only			2.8 1.3	MF222
17.38x7x15.25	454x178x387	Utility Bin + Holder	MY1627	25 11.3	5 2.2	MYUB1
23x7x15.25	584x178x387	Utility Bin + Holder	MY2030	25 11.3	5.1 2.3	MYUB2
16.38x6x11	416x152x279	Utility Bin Only			2 0.9	UB1



Wastebasket and Holder

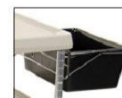

Utility Bin and Holder

Personalization Labels

Personalization labels provide easy identification

- Constructed of polyester material with a clear polyester flap to protect written information from wiping off.

4.37"L x .875"H (117.5x22.4mm)

Cat. No. MYCARTLBL-10PK (Pack of 10)



MY1627

Easy-grip handle and utility tray

- Small footprint for tight spaces.
- Accommodates Metro tote boxes and ISO totes.



MY2030

MY2030 cart handle has built-in recessed support channel to manage odd shaped items.

- Right-sized to fit : Glass & dish racks, bussing totes, silverware bins, milk crates.



MY2636

MY2636 cart handle has a built-in slot to hold scanners and labelers.

- Ideal for large bulky items. 5" (127mm) Caster makes cart easier to maneuver. 3-shelf model holds up to 500 lbs.

Indicates antimicrobial product.

Replacement Casters

4" (102mm) non-marking swivel caster. Used with MY1627 and MY2030 models.

Cat. No. RPBC4M-4 (Bag of 4)

5" (127mm) swivel resilient rubber caster. Used with MY2636 models.

Cat. No. 5M (sold individually)



What is Microban Antimicrobial Technology?

An antimicrobial is an additive placed into a product during the manufacturing process. By placing this additive, the product receives protection from microorganisms like bacteria, mold, mildew, and fungi. These organisms are known to cause odor and stains if not appropriately inhibited. By pairing your product with Microban Antimicrobial Technology, you reduce damaging bacteria and improve the lifespan of your product.



Microban Antimicrobial Protection works 24/7 to create an unlivable environment for microbes while helping to improve the appearance of the product by preventing stains and odor caused by bacterial build up. On an unprotected surface, bacteria can double in number every 20 minutes, leading to a full infestation in no-time, but with Microban antimicrobial technology, you can rest assured that your product remains cleaner between cleanings.

What are the benefits of a product with Microban antimicrobial protection?

- Helps prevent the growth of bacteria, fungi, mold, and mildew
- Keeps surfaces visibly cleaner
- Keeps products "cleaner between cleanings."
- Makes cleaning products easier
- Keeps surfaces cleaner longer after cleaning
- Will never wear down, as it is incorporated into the materials of the product
- Lasts the life of the product

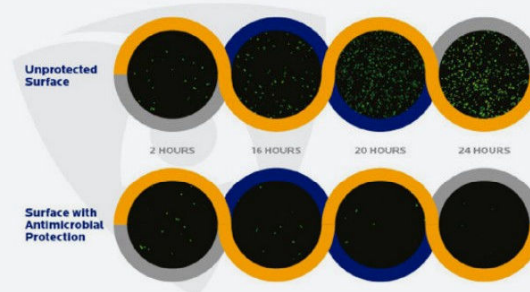



UTILITY CARTS

Deep Ledge Utility Carts — {12.28}

Specially designed with a 2.75" (70mm) deep ledge to contain product and spills.

- Polymer shelves are easy to clean and corrosion proof.
- Available colors are gray, black, and blue. Blue contains Microban antimicrobial product protection.
- Available in 2-shelf and 3-shelf models.
- Center shelf option adjusts at 1" (25mm) increments.



Width/Length/Height (mm)		Description	Approx. Pkd. Wt. (lbs.) (kg)		Cat. No.*	Cat. No. Slate Blue with Microban
(in.)	(mm)		(lbs.)	(kg)		
21.5x33.75x33.25	546x857x845	2-shelf unit	29	31.1	BC2030-2D	BC2030-2DMB
21.5x33.75x33.25	546x857x845	3-shelf unit	37.5	17.0	BC2030-3D	BC2030-3DMB
27x39.5x33.25	685x1003x845	2-shelf unit	35	15.9	BC2636-2D	BC2636-2DMB
27x39.5x33.25	685x1003x845	3-shelf unit	46.5	21.1	BC2636-3D	BC2636-3DMB

*Add color designation to part number when ordering: Gray (G), Black (BL). Example: BC2030-3DG = 3-shelf gray cart.

Weight load capacity for Deep Ledge series.
 150 lbs. (68kg) per shelf.
 2-shelf model: 300 lbs. (136kg)
 3-shelf model: 400 lbs. (181kg)

Gray

Black

Blue

MICROBAN
 PROTECTION THAT LASTS ALL DAY
 with Microban antimicrobial product protection

Accessories and Replacement Casters — {12.28}

- Utility Bin and Wastebasket can be easily removed from the holders to empty contents or for routine cleaning.

Description	Fits Cart	Width/Height/Depth		Approx. Pkd. Wt. (lbs.) (kg)	Deep Ledge Cat. No.
		(in.)	(mm)		
Wastebasket + Holder	BC2030	21.25x27.5x13.25	540x700x337	8.0 3.8	BCWB2D
Utility Bin + Holder	BC2030	21.25x7.75x14.5	540x197x368	6.0 2.7	BCUB2D
Wastebasket Only		14.38x15.38x10.38	365x391x264	2.8 1.3	MF222
Utility Bin Only		16.38x6x11	416x152x279	2.0 0.9	UB1
Replacement Caster					4MA

Note: Caster kit contains four 4" (102mm) swivel casters.



Basket Cart

Includes two light-duty basket style shelves, one standard wire shelf, four posts, extended handle, and four 4" diameter swivel casters (two with brakes)

- Basket shelves have a 3.5" (89mm) high edge to secure contents during transport.
- Durable chrome finish
- 400 lbs. (182kg) capacity per cart; 150 lbs. (68kg) capacity per shelf
- Ships in one box



Cart comes in point-of-sale box

Shelf Width/Length (in.) (mm)	Overall Length (including handle) (in.) (mm)	Overall Height (in.) (mm)	Approx. Pkd. Wt. (lbs.) (kg)	Cat. No.
18x36 457x914	39.88 1013	40.13 1020	49 22	BASCART-SR

UTILITY CARTS



MW200 Series



MW400 Series



MW600 Series



MW700 Series

MW Series Utility Carts — {12.01}{12.05} NSF

- Consist of Super Erecta wire shelves with plastic split sleeves, two one-piece handles of matching finish, and designated casters with donut bumpers.
- Two- and three-tier models available.
- 375 lbs. (170kg) weight capacity per cart. MW carts use light-duty resilient casters.
- 18" (457mm) wide carts have 4" (102mm) casters. Cart is 38" (965mm) high.
- 21" and 24" (530 and 610mm) wide carts have 5" (127mm) casters. Cart is 39" (990mm) high.

Utility Carts with Stainless Steel Solid Shelves

Width/Length (in.)	Width/Length (mm)	Approx. Pkd. Wt. (lbs.)	Approx. Pkd. Wt. (kg)	Cat. No. 2-Shelf	Approx. Pkd. Wt. (lbs.)	Approx. Pkd. Wt. (kg)	Cat. No. 3-Shelf
18x24	457x610	40	18.1	MW103	48	21.8	MW203
18x30	457x760	45	20.4	MW104	53	24.0	MW204
18x36	457x914	48	21.8	MW105	59	26.8	MW205
21x36	530x914	54	24.5	MW106	74	33.6	MW206
24x36	610x914	60	27.2	MW108	66	29.9	MW208

Utility Carts with 1 Solid, 2 Wire Shelves

Width/Length (in.)	Width/Length (mm)	Approx. Pkd. Wt. (lbs.)	Approx. Pkd. Wt. (kg)	Shelf Material	Handles	Cat. No.
18x24	457x610	43	19.5	Stainless Steel, Chrome	Chrome	MW401
18x30	457x760	47	21.3	Stainless Steel, Chrome	Chrome	MW402
18x36	457x914	52	23.6	Stainless Steel, Chrome	Chrome	MW403
21x36	530x914	59	26.8	Stainless Steel, Chrome	Chrome	MW404
24x36	610x914	65	29.5	Stainless Steel, Chrome	Chrome	MW406

Utility Carts with 2 Wire Shelves

Width/Length (in.)	Width/Length (mm)	Approx. Pkd. Wt. (lbs.)	Approx. Pkd. Wt. (kg)	Shelf Material	Handles	Cat. No.
18x24	457x610	34	15.4	Chrome	Chrome	MW601
18x24	457x610	34	15.4	Stainless Steel	Stainless Steel	MW602
18x30	457x760	37	16.8	Chrome	Chrome	MW603
18x30	457x760	37	16.8	Stainless Steel	Stainless Steel	MW604
18x36	457x914	40	18.1	Chrome	Chrome	MW605
18x36	457x914	39	17.7	Stainless Steel	Stainless Steel	MW606
21x36	530x914	44	20.0	Chrome	Chrome	MW607
21x36	530x914	44	20.0	Stainless Steel	Stainless Steel	MW608
24x36	610x914	47	21.3	Chrome	Chrome	MW611
24x36	610x914	46	20.9	Stainless Steel	Stainless Steel	MW612

Utility Carts with 3 Wire Shelves

Width/Length (in.)	Width/Length (mm)	Approx. Pkd. Wt. (lbs.)	Approx. Pkd. Wt. (kg)	Shelf Material	Handles	Cat. No.
18x24	457x610	39	17.6	Chrome	Chrome	MW701
18x24	457x610	38	17.2	Stainless Steel	Stainless Steel	MW702
18x30	457x760	43	19.5	Chrome	Chrome	MW703
18x30	457x760	42	19.1	Stainless Steel	Stainless Steel	MW704
18x36	457x914	47	21.3	Chrome	Chrome	MW705
18x36	457x914	45	20.4	Stainless Steel	Stainless Steel	MW706
21x36	530x914	50	22.7	Chrome	Chrome	MW707
21x36	530x914	50	22.7	Stainless Steel	Stainless Steel	MW708
24x36	610x914	60	27.7	Chrome	Chrome	MW711
24x36	610x914	57	25.9	Stainless Steel	Stainless Steel	MW712



HEAVY-DUTY UTILITY CARTS

SP Series Utility Carts — {12.10}

- Consist of Super Erecta wire shelves with plastic split sleeves, two one-piece handles of matching finish, and designated casters with donut bumpers.
- Two- and three-tier models available.
- 5" (127mm) casters allow for transport of heavier loads than the MW Series Carts.
- 39" (990mm) high.

- Super Erecta Brite finish** — 600 lbs. (273kg) capacity per cart
- 5M Resilient Rubber Casters; casters have plated horns and axles.

Shelf Width/Length (in.)	Shelf Width/Length (mm)	2-TIER MODELS		3-TIER MODELS	
		Approx. Pkd. Wt. (lbs.) (kg)	Cat. No. Super Erecta Brite	Approx. Pkd. Wt. (lbs.) (kg)	Cat. No. Super Erecta Brite
18x36	457x914	40 18	2SPN33ABR	50 22.5	3SPN33ABR
21x36	530x914	44 20	2SPN43ABR	55 24.7	3SPN43ABR
24x36	610x914	48 22	2SPN53ABR	61 27.4	3SPN53ABR
24x48	610x1219	54 24	2SPN55ABR	70 31.5	3SPN55ABR
24x60	610x1524	64 29	2SPN56ABR	85 38.2	3SPN56ABR



2-Tier with 5M casters

- Chrome finish** — 900 lbs. (410kg) capacity per cart

- 5MP Polyurethane Casters; casters have plated horns and axles.

Shelf Width/Length (in.)	Shelf Width/Length (mm)	2-TIER MODELS		3-TIER MODELS	
		Approx. Pkd. Wt. (lbs.) (kg)	Cat. No. Chrome	Approx. Pkd. Wt. (lbs.) (kg)	Cat. No. Chrome
18x36	457x914	40 18	2SPN33DC	50 22.5	3SPN33DC
21x36	530x914	44 20	2SPN43DC	55 24.7	3SPN43DC
24x36	610x914	48 22	2SPN53DC	61 27.4	3SPN53DC
24x48	610x1219	54 24	2SPN55DC	70 31.5	3SPN55DC
24x60	610x1524	64 29	2SPN56DC	85 38.2	3SPN56DC



3-Tier with 5MP casters

- Type 304 Stainless Steel** — 900 lbs. (410kg) capacity per cart

- 5PC Polyurethane Casters; casters have polymer horns and stainless steel axles.

Shelf Width/Length (in.)	Shelf Width/Length (mm)	2-TIER MODELS		3-TIER MODELS	
		Approx. Pkd. Wt. (lbs.) (kg)	Cat. No. Stainless Steel	Approx. Pkd. Wt. (lbs.) (kg)	Cat. No. Stainless Steel
18x36	457x914	40 18	2SPN33PS	50 22.5	3SPN33PS
21x36	530x914	44 20	2SPN43PS	55 24.7	3SPN43PS
24x36	610x914	48 22	2SPN53PS	61 27.4	3SPN53PS
24x48	610x1219	54 24	2SPN55PS	70 31.5	3SPN55PS
24x60	610x1524	64 29	2SPN56PS	85 38.2	3SPN56PS



3-Tier with 5PC casters

One-Piece Handles — {12.10}

May be used with Super Erecta shelving, casters, and components to customize a cart to your exact needs.

Shelf Width/Length (in.)	Shelf Width/Length (mm)	Approx. Pkd. Wt. (lbs.) (kg)	Cat. No. Chrome	Cat. No. Stainless Steel
18	457	5 1/2 2.5	H3C	H3S
21	533	5 1/4 2.6	H4C	H4S
24	610	6 2.7	H5C	H5S

Height: 34.5" (876mm).



One-Piece Handle

BOW-TIE™ DUNNAGE RACKS



MICROBAN
Bow-Tie Dunnage Rack



Standard racks joined in "end-to-end" configuration.

Bow-Tie™ Dunnage Racks — {9.09}

12" (305mm) high; 22" (559mm) wide.

- Metro Bow-Tie Dunnage Racks are available with built-in Microban® antimicrobial product protection to protect from bacteria, mold, mildew and fungi that cause odors, stains and product degradation. Standard models, without Microban, are also available.
- Rust and corrosion-proof polymer material.
- Helps protect floors: legs have a larger radius than traditional dunnage racks and distribute the storage load across a wider area.
- Racks join together easily without tools in "end-to-end" and "back-to-back" configurations with the exclusive Bow-Tie™ feature.
- Heavy-duty construction gives racks the strength to hold up to 1,500 lbs. (683kg) for 30" (760mm) and 36" (914mm) long racks, and 3,000 (1365kg) for 48" (1219mm) and 60" (1524mm) racks.

Length (in.)	Length (mm)	Height (in.)	Height (mm)	Approx. Pkd. Wt.		Capacity (lbs.)	Capacity (kg)	Cat. No. Microban®	Cat. No. Standard
				(lbs.)	(kg)				
30	760	12	305	24	10.8	1500	68	HP2230PDMB	HP2230PD
36	914	12	305	26	11.7	1500	68	HP2236PDMB	HP2236PD
48	1219	12	305	34	15.3	3000	136	HP2248PDMB	HP2248PD
60	1524	12	305	42	19	3000	136	HP2260PDMB	HP2260PD

☑ Indicates antimicrobial product.



DUNNAGE RACKS

Dunnage Platforms (Standard Duty) — {10.44}

Space-saving platforms let you keep bulky items off the floor.

- Open wire provides air circulation and minimizes dust.
- All platforms use 13P or 13PS posts — height 14.63" (371mm) including cap and leveling bolt.

Width/Length (in.) (mm)	Approx. Pkd. Wt. (lbs.) (kg)	Cat. No. Super Erecta Brite	Cat. No. Chrome	Cat. No. Stainless
18x24 457x610	11 5.0	P1824BR	P1824NC	P1824NS
18x30 457x760	12 5.5	P1830BR	P1830NC	P1830NS
18x36 457x914	13.5 6.1	P1836BR	P1836NC	P1836NS
21x24 530x610	12 5.5	P2124BR	P2124NC	P2124NS
21x30 530x760	13 5.9	P2130BR	P2130NC	P2130NS
21x36 530x914	15 6.8	P2136BR	P2136NC	P2136NS
24x24 610x610	13 5.9	P2424BR	P2424NC	P2424NS
24x30 610x760	15 6.8	P2430BR	P2430NC	P2430NS
24x36 610x914	17 7.7	P2436BR	P2436NC	P2436NS



Super Erecta Platform

Heavy-Duty Dunnage Racks — {10.46}

A space-efficient way to store large, bulky items off the floor.

- Removable top mat lifts off for cleaning.
- Dunnage racks are 14.5" (368mm) high including mat, cap and leveling bolt.

Width/Length (in.) (mm)	Approx. Pkd. Wt. (lbs.) (kg)	Cat. No. Chrome	Cat. No. Metroseal Green with Microban®	Cat. No. Stainless
18x24 457x610	22 10	HP31C	HP31K3	
18x30 457x760	25 11	HP32C	HP32K3	
18x36 457x914	30 13	HP33C	HP33K3	HP33S
18x48 457x1219	38 17	HP35C*	HP35K3*	HP35S*
24x24 610x610	28 12	HP51C	HP51K3	
24x30 610x760	30 14	HP52C	HP52K3	
24x36 610x914	36 16	HP53C	HP53K3	HP53S
24x48 610x1219	42 19	HP55C*	HP55K3*	HP55S*

Note: Maximum distributed static load capacity for stationary dunnage racks is 1,600 lbs. (725kg), except on units marked * which have a 1,300 lb. (590kg) capacity.



Dunnage Rack with Mat

Mobile Dunnage Racks (Heavy Duty) — {10.46}

These easy-to-manuever racks feature two swivel and two swivel/brake casters; with non-marking polyurethane tread.

- Support frames: 1" (25mm) square tubing.
- Removable wire mat: .313" (7.9mm) diameter wire.

Width/Length (in.) (mm)	Approx. Pkd. Wt. (lbs.) (kg)	Cat. No. Chrome	Cat. No. Metroseal Green with Microban®	Cat. No. Stainless
18x36 457x914	42 18.9	MHP33C	MHP33K3	MHP33S
18x48 457x1219	50 22.5	MHP35C	MHP35K3	MHP35S
24x36 610x914	48 21.6	MHP53C	MHP53K3	MHP53S
24x48 610x1219	54 24.3	MHP55C	MHP55K3	MHP55S

Maximum distributed static load capacity is 800 lbs. (363kg).
Note: These units are designed for only the SHP and SHPB casters, which are shipped assembled with the special posts.



Mobile Dunnage Rack shown in Metroseal Green finish

HD Super Duty Dunnage Racks

Stores more than a ton safely off the floor.

- 48" (1219mm) rack has a 3,000 pound (1361kg) static load capacity (uniformly distributed); 60" (1524mm) rack carries up to 2,400 pounds (1089kg).
- HD Super™ design features fast, secure assembly without tools.
- Posts of 1.625" (41mm) diameter provide greater rigidity.
- HD Super™ Dunnage Racks are 16.25" (413mm) high including cap and leveling bolt.

Width/Length (in.) (mm)	Approx. Pkd. Wt. (lbs.) (kg)	Cat. No. Chrome
18x48 457x1219	52 23.4	HDP35C
18x60 457x1524	62 27.9	HDP36C
24x48 610x1219	57 26.6	HDP55C
24x60 610x1524	66 29.7	HDP56C

Maximum capacity 2,400 pounds (1089kg) uniformly distributed static load on the 60" (1524mm) length racks; 3,000 pounds (1361kg) on the 48" (1219mm) length racks.
Note: Capacity will be reduced and the unit will become less stable if the 3-sided frame is mounted higher than 6" (152mm) from the floor.



HD Super Dunnage Rack



Indicates antimicrobial product.